

SANDIA REPORT

SAND2024-14132
Printed October 2024



Sandia
National
Laboratories

Xyce™ Parallel Electronic Simulator Reference Guide, Version 7.9

Eric R. Keiter, Richard L. Schiek, Heidi K. Thornquist,
Ting Mei, Jason C. Verley, Karthik V. Aadithya,
Joshua D. Schickling, Gary L. Hennigan

Prepared by
Sandia National Laboratories
Albuquerque, New Mexico 87185
Livermore, California 94550

Issued by Sandia National Laboratories, operated for the United States Department of Energy by National Technology & Engineering Solutions of Sandia, LLC.

NOTICE: This report was prepared as an account of work sponsored by an agency of the United States Government. Neither the United States Government, nor any agency thereof, nor any of their employees, nor any of their contractors, subcontractors, or their employees, make any warranty, express or implied, or assume any legal liability or responsibility for the accuracy, completeness, or usefulness of any information, apparatus, product, or process disclosed, or represent that its use would not infringe privately owned rights. Reference herein to any specific commercial product, process, or service by trade name, trademark, manufacturer, or otherwise, does not necessarily constitute or imply its endorsement, recommendation, or favoring by the United States Government, any agency thereof, or any of their contractors or subcontractors. The views and opinions expressed herein do not necessarily state or reflect those of the United States Government, any agency thereof, or any of their contractors.

Printed in the United States of America. This report has been reproduced directly from the best available copy.

Available to DOE and DOE contractors from

U.S. Department of Energy
Office of Scientific and Technical Information
P.O. Box 62
Oak Ridge, TN 37831

Telephone: (865) 576-8401
Facsimile: (865) 576-5728
E-Mail: reports@osti.gov
Online ordering: <http://www.osti.gov/scitech>

Available to the public from

U.S. Department of Commerce
National Technical Information Service
5301 Shawnee Road
Alexandria, VA 22312

Telephone: (800) 553-6847
Facsimile: (703) 605-6900
E-Mail: orders@ntis.gov
Online order: <https://classic.ntis.gov/help/order-methods>



ABSTRACT

This document is a reference guide to the Xyce Parallel Electronic Simulator, and is a companion document to the Xyce Users' Guide [1] . The focus of this document is (to the extent possible) exhaustively list device parameters, solver options, parser options, and other usage details of Xyce. This document is *not* intended to be a tutorial. Users who are new to circuit simulation are better served by the Xyce Users' Guide [1] .

This page intentionally left blank.

ACKNOWLEDGMENTS

We would like to acknowledge all the developers, DevOps engineers, and Scrum team members who have contributed to the Xyce project over the years: Aaron Gibson, Alan Lundin, Antonio Gonzales, Ashley Meek, Bart van Bloemen Waanders, Brad Bond, Brian Fett, Christina Warrender, David Baur, David Collins, David Day, David Shirley, Debbie Serna, Deborah Fixel, Derek Barnes, Eric Rankin, Erik Zeek, Herman "Buddy" Watts, Hue Lai, Jim Emery, Jonathan Woodbridge, Jonathen Kwok, Josh Smith, Keith Santarelli, Laura Boucheron, Lawrence Musson, Lon Waters, Mary Meinelt, Michael Skoufis, Mingyu "Genie" Hsieh, Nicholas Johnson, Peter Sholander, Philip Campbell, Rachel Campbell, Randall Lober, Rebecca Arnold, Regina Schells, Richard Drake, Robert Hoekstra, Roger Pawlowski, Russell Hooper, Samuel Browne, Scott Hutchinson, Simon Zou, Smitha Sam, Steven Verzi, Tamara Kolda, Thomas V. Russo, Timur Takhtaganov, and Todd Coffey.

Also, thanks to for the original typesetting of this document in L^AT_EX.

Trademarks

Xyce Electronic Simulator™ and Xyce™ are trademarks of National Technology & Engineering Solutions of Sandia, LLC (NTESS).

Contact Information

Address

Electrical Models & Simulation Dept.
Sandia National Laboratories
P.O. Box 5800, MS 1177
Albuquerque, NM 87185-1177

Outside Sandia

World Wide Web

<http://xyce.sandia.gov>

Email

xyce@sandia.gov

Inside Sandia

World Wide Web

<https://info-ng.sandia.gov/xyce/>

Email

xyce-sandia@sandia.gov

This document is copyright © 2002-2024 National Technology & Engineering Solutions of Sandia, LLC.



This page intentionally left blank.

CONTENTS

1. Introduction	21
1.1. Overview	22
1.2. How to Use this Guide	22
1.3. Typographical conventions	22
2. Netlist Reference	23
2.1. Netlist Commands	24
2.1.1. .AC (AC Analysis)	24
2.1.2. .DATA (Data Table for sweeps)	26
2.1.3. .DC (DC Sweep Analysis)	27
2.1.3.1. Linear Sweeps	27
2.1.3.2. Decade Sweeps	27
2.1.3.3. Octave Sweeps	28
2.1.3.4. List Sweeps	28
2.1.3.5. Data Sweeps	28
2.1.4. .DCVOLT (Initial Condition, Bias point)	29
2.1.5. .EMBEDEDSAMPLING (Embedded Sampling)	30
2.1.6. .END (End of Circuit)	33
2.1.7. .ENDS (End of Subcircuit)	34
2.1.8. .FFT (FFT Analysis)	35
2.1.8.1. .OPTIONS FFT FFT_MODE	37
2.1.8.2. Window Functions	37
2.1.8.3. Additional FFT Metrics	38
2.1.8.4. Re-Measure	39
2.1.8.5. Compatibility Between OUTPUT and FFT Options	39
2.1.9. .FOUR (Fourier Analysis)	40
2.1.10. .FUNC (Function)	42
2.1.11. .GLOBAL (Global Node)	44
2.1.12. .GLOBAL_PARAM (Global parameter)	45
2.1.13. .HB (Harmonic Balance Analysis)	47
2.1.14. .IC (Initial Condition, Bias point)	48
2.1.15. .INC or .INCLUDE or .INCL (Include file)	49
2.1.16. .LIB (Library file)	50
2.1.16.1. .LIB call statement	50
2.1.16.2. .LIB definition statement	50
2.1.17. .LIN (Linear Analysis)	52
2.1.18. .MEASURE or .MEAS (Measure output)	54
2.1.18.1. Measure Output	65
2.1.18.2. Measurement Windows	66
2.1.18.3. Expression Support	66
2.1.18.4. Re-Measure	67

2.1.18.5.	RISE, FALL and CROSS Qualifiers	68
2.1.18.6.	Additional Examples	70
2.1.18.7.	Suppresssing Measure Output	71
2.1.18.8.	ERROR Functions (ERR1 and ERR2)	72
2.1.18.9.	ERROR Measure	72
2.1.18.10.	Operator Support for AC Mode Measures	73
2.1.18.11.	Operator Support for NOISE Mode Measures	73
2.1.18.12.	Behavior for Unsupported Modes and Types	74
2.1.18.13.	Compatibility with .DATA	74
2.1.18.14.	HSPICE Compatibility	75
2.1.18.15.	Legacy Trig-Targ Mode (LTTM)	76
2.1.19.	.MEASURE (Continuous results)	78
2.1.19.1.	Measure Output	81
2.1.19.2.	RISE, FALL and CROSS Qualifiers	82
2.1.19.3.	AT and TD Qualifiers for TRIG-TARG	83
2.1.19.4.	HSPICE Compatibility	83
2.1.20.	.MEASURE FFT (Measure output for .FFT)	84
2.1.20.1.	Measure Definitions	87
2.1.20.2.	Re-Measure	87
2.1.20.3.	Additional Examples	87
2.1.21.	.MODEL (Model Definition)	89
2.1.21.1.	LEVEL Parameter	90
2.1.21.2.	Model Binning	90
2.1.21.3.	Length Scaling	90
2.1.22.	.NODESET (Approximate Initial Condition, Bias point)	92
2.1.23.	.NOISE (Noise Analysis)	93
2.1.24.	.OP (Bias Point Analysis)	95
2.1.25.	.OPTIONS Statements	96
2.1.25.1.	.OPTIONS DEVICE (Device Package Options)	97
2.1.25.2.	.OPTIONS DIAGNOSTIC (Diagnostic Simulation Output)	99
2.1.25.3.	.OPTIONS TIMEINT (Time Integration Options)	99
2.1.25.4.	.OPTIONS NONLIN (Nonlinear Solver Options)	103
2.1.25.5.	.OPTIONS LOCA (Continuation and Bifurcation Tracking Package Options)	105
2.1.25.6.	.OPTIONS LINSOL (Linear Solver Options)	106
2.1.25.7.	.OPTIONS LINSOL-HB (Linear Solver Options)	109
2.1.25.8.	.OPTIONS LINSOL-AC (Linear Solver Options)	109
2.1.25.9.	.OPTIONS OUTPUT (Output Options)	110
2.1.25.10.	.OPTIONS RESTART (Checkpointing Options)	111
2.1.25.11.	.OPTIONS RESTART (Restarting Options)	112
2.1.25.12.	.OPTIONS RESTART: special notes for use with two-level-Newton	112
2.1.25.13.	.OPTIONS SAMPLES (Sampling options)	113
2.1.25.14.	.OPTIONS EMBEDDEDSAMPLES (Embedded Sampling options)	113
2.1.25.15.	.OPTIONS PCES (Fully intrusive PCE options)	114
2.1.25.16.	.OPTIONS SENSITIVITY (Direct and Adjoint Sensitivity Options)	115
2.1.25.17.	.OPTIONS HBINT (Harmonic Balance Options)	116
2.1.25.18.	.OPTIONS DIST (Parallel Distribution Options)	116
2.1.25.19.	.OPTIONS FFT (FFT Options)	117
2.1.25.20.	.OPTIONS MEASURE (Measure Options)	118

2.1.25.21.	.OPTIONS PARSER (Parser Options)	119
2.1.26.	.PARAM (Parameter)	120
2.1.27.	.PCE (Fully Intrusive Polynomial Chaos Expansion (PCE) Analysis)	122
2.1.28.	.PREPROCESS REPLACEGROUND (Ground Synonym)	125
2.1.29.	.PREPROCESS REMOVEUNUSED (Removal of Unused Components)	126
2.1.30.	.PREPROCESS ADDRESISTORS (Adding Resistors to Dangling Nodes)	127
2.1.31.	.PRINT (Print output)	128
2.1.31.1.	Print AC Analysis	136
2.1.31.2.	Print DC Analysis	137
2.1.31.3.	Print Harmonic Balance Analysis	137
2.1.31.4.	Print Noise Analysis	139
2.1.31.5.	Print Transient Analysis	140
2.1.31.6.	Print Homotopy	141
2.1.31.7.	Print Sensitivity	141
2.1.31.8.	Print Embedded Sampling Analysis	143
2.1.31.9.	Print Intrusive PCE Analysis	143
2.1.31.10.	Parameter Stepping	144
2.1.31.11.	Print Wildcards	146
2.1.31.12.	Device Parameters and Internal Variables	147
2.1.32.	.RESULT (Print results)	149
2.1.32.1.	Example Netlist	149
2.1.33.	.SAMPLING (Sampling UQ Analysis)	150
2.1.34.	.SAVE (Save operating point conditions)	152
2.1.35.	.SENS (Compute DC, AC or transient sensitivities)	153
2.1.36.	.STEP (Step Parametric Analysis)	155
2.1.36.1.	Linear Sweeps	155
2.1.36.2.	Decade Sweeps	157
2.1.36.3.	Octave Sweeps	157
2.1.36.4.	List Sweeps	157
2.1.36.5.	Data Sweeps	157
2.1.37.	.SUBCKT (Subcircuit)	159
2.1.38.	.TRAN (Transient Analysis)	161
2.1.39.	Miscellaneous Commands	163
2.1.39.1.	* (Comment)	163
2.1.39.2.	; (In-line Comment)	163
2.1.39.3.	+ (Line Continuation)	163
2.2.	Expressions	164
2.2.1.	Expressions in .PARAM or .GLOBAL_PARAM Statements	171
2.2.2.	Expressions in .PRINT Lines	172
2.2.3.	Using Complex Values in Expressions	173
2.2.4.	Expressions for Device Instance and Model Parameters	173
2.2.5.	POLY expressions	174
2.2.5.1.	Voltage-controlled sources	174
2.2.5.2.	Current-controlled sources	175
2.2.5.3.	B sources	175
2.3.	Devices	177
2.3.1.	Voltage Nodes	182
2.3.1.1.	Global nodes	182

2.3.1.2. Subcircuit Nodes	182
2.3.2. Legal Characters in Node and Device Names	184
2.3.3. Lead Currents and Power Calculations	185
2.3.4. Capacitor	186
2.3.5. Inductor	191
2.3.6. Mutual Inductors	194
2.3.7. Resistor	201
2.3.8. Diode	207
2.3.9. Independent Current Source	221
2.3.10. Independent Voltage Source	226
2.3.11. Port Device	231
2.3.12. Voltage Controlled Voltage Source	232
2.3.13. Current Controlled Current Source	234
2.3.14. Voltage Controlled Current Source	235
2.3.15. Current Controlled Voltage Source	237
2.3.16. Nonlinear Dependent Source	238
2.3.17. Bipolar Junction Transistor (BJT)	241
2.3.17.1. The Level 1 Model	243
2.3.17.2. VBIC Temperature Considerations	245
2.3.17.3. Level 1 BJT Tables	247
2.3.17.4. Level 11 and 12 BJT Tables (VBIC 1.3)	249
2.3.17.5. Level 23 BJT Tables (FBH HBT_X)	259
2.3.17.6. Level 230 BJT Tables (HICUM/L0)	262
2.3.17.7. Level 234 BJT Table (HICUM/L2)	267
2.3.17.8. Level 504 and 505 BJT Tables (MEXTRAM)	273
2.3.18. Junction Field-Effect Transistor (JFET)	287
2.3.19. Metal-Semiconductor FET (MESFET)	291
2.3.20. MOS Field Effect Transistor (MOSFET)	293
2.3.20.1. Level 1 MOSFET Tables (SPICE Level 1)	306
2.3.20.2. Level 2 MOSFET Tables (SPICE Level 2)	308
2.3.20.3. Level 3 MOSFET Tables (SPICE Level 3)	310
2.3.20.4. Level 6 MOSFET Tables (SPICE Level 6)	312
2.3.20.5. Level 9 MOSFET Tables (BSIM3)	314
2.3.20.6. Level 10 MOSFET Tables (BSIM-SOI)	328
2.3.20.7. Level 14/54 MOSFET Tables (BSIM4)	350
2.3.20.8. Level 18 MOSFET Tables (VDMOS)	380
2.3.20.9. Levels 70 and 70450 MOSFET Tables (BSIM-SOI 4.6.1 and 4.5.0)	384
2.3.20.10. Level 77 MOSFET Tables (BSIM6 version 6.1.1)	445
2.3.20.11. Level 102 MOSFET Tables (PSP version 102.5)	475
2.3.20.12. Level 103 and 1031 MOSFET Tables (PSP version 103.4)	493
2.3.20.13. Level 111 MOSFET Tables (BSIM CMG version 111.2.1)	566
2.3.20.14. Level 110 MOSFET Tables (BSIM CMG version 110.0.0)	626
2.3.20.15. Level 107 and 108 MOSFET Tables (BSIM CMG versions 107.0.0 and 108.0.0)	663
2.3.20.16. Levels 2000 and 2001 MOSFET Tables (MVS version 2.0.0)	728
2.3.20.17. Level 2002 MOSFET Tables (MVSG_CMC version 1.1.0)	730
2.3.20.18. Level 260 MOSFET Tables (EKV version 2.6)	737
2.3.20.19. Level 301 MOSFET Tables (EKV version 3.0.1)	740

2.3.20.20. Level 10240 MOSFET Tables (L_UTSOI Version 102.4.0)	748
2.3.21. Lossy Transmission Line (LTRA)	763
2.3.22. Voltage- or Current-controlled Switch	765
2.3.23. Generic Switch	769
2.3.24. Linear device	770
2.3.25. Lossless (Ideal) Transmission Line	772
2.3.26. Lumped Transmission Line	774
2.3.27. Ideal Delay	776
2.3.27.1. Delay device instance parameters	777
2.3.28. Behavioral Digital Devices	778
2.3.29. Y-Type Behavioral Digital Devices (Deprecated)	783
2.3.30. Accelerated mass	788
2.3.31. Power Grid	789
2.3.32. Memristor Device	800
2.3.33. Subcircuit	806
2.4. TCAD Devices	807
2.4.1. Physical Models	817
2.4.1.1. Material Models and Parameters	817
2.4.1.2. Effective Mass	817
2.4.1.3. Electron Effective Mass	817
2.4.1.4. Hole Effective Mass	817
2.4.1.5. Intrinsic Carrier Concentration	818
2.4.1.6. Bandgap	818
2.4.2. Mobility Models	820
2.4.2.1. Analytic Mobility	820
2.4.2.2. Arora Mobility	821
2.4.2.3. Carrier-Carrier Scattering Mobility	822
2.4.2.4. Lombardi Surface Mobility Model	824
2.4.2.5. Edge Mobilities	826
2.4.2.6. Boundary Conditions for Electrode Contacts	827
2.4.2.7. Neutral Contacts	827
2.4.2.8. Schottky Contacts	828
2.4.2.9. Metal-Oxide-Semiconductor Contacts	832
2.4.2.10. NMOS Device	832
3. Command Line Arguments	835
3.1. Hspice extensions	837
3.2. Redefined parameters	837
4. Runtime Environment	839
4.1. Running Xyce in Serial	839
4.2. Running Xyce in Parallel	839
4.3. Running Xyce on Sandia HPC and CEE Platforms	839
5. Setting Convergence Parameters for Xyce	841
5.1. Adjusting Transient Analysis Error Tolerances	841
5.1.1. Setting RELTOL and ABSTOL	841
5.2. Adjusting Nonlinear Solver Parameters (in transient mode)	842

6. Quick Reference for Users of Other SPICE Circuit Simulators	843
6.1. Differences Between Xyce and PSpice	843
6.1.1. Command Line Options	843
6.1.2. Device Support	843
6.1.3. .OPTIONS Support	843
6.1.4. .PROBE vs. .PRINT	845
6.1.5. Converting PSpice ABM Models for Use in Xyce	845
6.1.6. Usage of .STEP Analysis	845
6.1.6.1. Model Parameter Sweeps	845
6.1.7. Behavioral Digital Devices	846
6.1.8. Power Dissipation	846
6.1.9. Dependent Sources with TABLE Syntax	846
6.1.10. MODEL STATEMENTS	847
6.1.11. .NODESET and .IC Statements	847
6.1.12. Piecewise Linear Sources	848
6.1.13. .AC Output	848
6.1.14. Additional differences	849
6.1.15. Translating Between PSpice and Xyce Netlists	851
6.2. Differences Between Xyce and Other SPICE Simulators	851
6.3. DC Operating Point Calculation Failures in Xyce	853
6.3.1. Incompatible Voltage Constraints at Circuit Nodes	853
6.3.2. Multiple Voltage Constraints From Subcircuits or at Global Nodes	854
6.3.3. NODESET and IC Statements in Subcircuits	854
6.3.4. No DC Path to Ground for a Current Flow	855
6.3.5. Inductor Loops	855
6.3.6. Infinite Slope Transistions	855
6.3.7. Simulation Settings	855
7. Quick Reference for Microsoft Windows Users	857
8. Rawfile Format	859
8.1. ASCII Format	859
8.2. Binary Format	860
8.3. Special Notes	860
References	861
Appendices	864
A. Third Party Licenses	865
Index	881
Distribution	888

LIST OF FIGURES

Figure 2-1. Model Binning Example	90
Figure 2-2. Scale Example	91
Figure 2-3. BJT model schematic	242
Figure 2-4. VBIC thermal network schematic	245
Figure 2-5. Lumped Π Model for PowerGridBranch	797
Figure 2-6. Equivalent Circuit for PowerGridbusShunt	797
Figure 2-7. Equivalent Circuit for PowerGridTransformer	799
Figure 2-8. Neutral Contacts	828
Figure 2-9. Schottky Contact, N-type	829
Figure 2-10. Schottky Contact, P-type	830

This page intentionally left blank.

LIST OF TABLES

Table 1-1.	Xyce typographical conventions.	22
Table 2-1.	.FFT Window Function Definitions (N = Number of Points).	37
Table 2-2.	RISE, FALL and CROSS Support in .MEASURE.	69
Table 2-3.	Options for Device Package	97
Table 2-4.	Options for Diagnostic Output	99
Table 2-5.	Options for Time Integration Package.	100
Table 2-6.	Options for Nonlinear Solver Package.	103
Table 2-7.	Options for Continuation and Bifurcation Tracking Package.	105
Table 2-8.	Options for Linear Solver Package.	106
Table 2-9.	Options for Linear Solver Package for HB.	109
Table 2-10.	Options for Sampling Package.	113
Table 2-11.	Options for Embedded Sampling Package.	114
Table 2-12.	Options for PCE Package.	114
Table 2-13.	Options for Sensitivity Package.	115
Table 2-14.	Options for HB.	116
Table 2-15.	Options for Parallel Distribution.	117
Table 2-16.	Options for FFT.	118
Table 2-17.	Options for MEASURE.	119
Table 2-18.	Options for Parsing.	119
Table 2-19.	Print AC Analysis Type	136
Table 2-20.	Print DC Analysis Type	137
Table 2-21.	Print HB Analysis Type	138
Table 2-22.	Print NOISE Analysis Type	139
Table 2-23.	Print Transient Analysis Type	140
Table 2-24.	Print Homotopy	141
Table 2-25.	Print Sensitivities for .TRAN and .DC	141
Table 2-26.	Print Sensitivities for .AC	142
Table 2-27.	Print Transient Adjoint Sensitivities	143
Table 2-28.	Print EMBEDDEDSAMPLING Analysis Type	143
Table 2-29.	Print PCE Analysis Type	144
Table 2-32.	Operators	164
Table 2-33.	Arithmetic Functions	166
Table 2-34.	SPICE Compatibility Functions	171
Table 2-35.	Analog Device Quick Reference.	177
Table 2-35.	Analog Device Quick Reference.	178
Table 2-36.	Features Supported by Xyce Device Models	179
Table 2-37.	Capacitor Device Instance Parameters	187
Table 2-38.	Capacitor Device Model Parameters	188
Table 2-39.	Inductor Device Instance Parameters	193
Table 2-40.	Inductor Device Model Parameters	193

Table 2-41.	Nonlinear Mutual Inductor Device Model Parameters	195
Table 2-42.	Resistor Device Instance Parameters	203
Table 2-43.	Resistor Device Model Parameters	203
Table 2-44.	Resistor Device Instance Parameters	204
Table 2-45.	Resistor Device Model Parameters	205
Table 2-46.	Diode Device Instance Parameters	208
Table 2-47.	Diode Device Model Parameters	208
Table 2-48.	JUNCAP200 Diode Device Instance Parameters	209
Table 2-49.	JUNCAP200 Diode Device Model Parameters	210
Table 2-50.	Diode level 200 Output Variables	212
Table 2-51.	DIODE_CMC 2.0.0 Device Instance Parameters	213
Table 2-52.	DIODE_CMC 2.0.0 Device Model Parameters	213
Table 2-53.	Diode level 2002 Output Variables	216
Table 2-54.	Pulse Parameters	222
Table 2-55.	Sine Parameters	222
Table 2-56.	Exponent Parameters	222
Table 2-57.	Pattern Parameters	223
Table 2-58.	Piecewise Linear Parameters	224
Table 2-59.	Frequency Modulated Parameters	225
Table 2-60.	Pulse Parameters	227
Table 2-61.	Sine Parameters	227
Table 2-62.	Exponent Parameters	227
Table 2-63.	Pattern Parameters	228
Table 2-64.	Piecewise Linear Parameters	229
Table 2-65.	Frequency Modulated Parameters	230
Table 2-66.	Expression Based Voltage or Current Source Device Instance Parameters	240
Table 2-67.	Bipolar Junction Transistor Device Instance Parameters	247
Table 2-68.	Bipolar Junction Transistor Device Model Parameters	247
Table 2-69.	VBIC 1.3 3T Device Instance Parameters	250
Table 2-70.	VBIC 1.3 3T Device Model Parameters	250
Table 2-71.	VBIC 1.3 4T Device Instance Parameters	255
Table 2-72.	VBIC 1.3 4T Device Model Parameters	255
Table 2-73.	FBH HBT_X v2.1 Device Instance Parameters	259
Table 2-74.	FBH HBT_X v2.1 Device Model Parameters	259
Table 2-75.	HICUM L0 v1.32 Device Instance Parameters	262
Table 2-76.	HICUM L0 v1.32 Device Model Parameters	262
Table 2-77.	BJT level 230 Output Variables	265
Table 2-78.	HICUM v2.4.0 Device Model Parameters	267
Table 2-79.	BJT level 234 Output Variables	271
Table 2-80.	MEXTRAM 504.12.1 Device Instance Parameters	273
Table 2-81.	MEXTRAM 504.12.1 Device Model Parameters	273
Table 2-82.	BJT level 504 Output Variables	276
Table 2-83.	MEXTRAM 504.12.1 with self heating Device Instance Parameters	280
Table 2-84.	MEXTRAM 504.12.1 with self heating Device Model Parameters	280
Table 2-85.	BJT level 505 Output Variables	283
Table 2-86.	JFET Device Instance Parameters	288
Table 2-87.	JFET Device Model Parameters	288
Table 2-88.	JFET Device Instance Parameters	289

Table 2-89.	JFET Device Model Parameters	289
Table 2-90.	MESFET Device Instance Parameters	292
Table 2-91.	MESFET Device Model Parameters	292
Table 2-92.	MOSFET level 1 Device Instance Parameters	306
Table 2-93.	MOSFET level 1 Device Model Parameters	306
Table 2-94.	MOSFET level 2 Device Instance Parameters	308
Table 2-95.	MOSFET level 2 Device Model Parameters	308
Table 2-96.	MOSFET level 3 Device Instance Parameters	310
Table 2-97.	MOSFET level 3 Device Model Parameters	310
Table 2-98.	MOSFET level 6 Device Instance Parameters	312
Table 2-99.	MOSFET level 6 Device Model Parameters	312
Table 2-100.	BSIM3 Device Instance Parameters	314
Table 2-101.	BSIM3 Device Model Parameters	315
Table 2-102.	BSIM3 SOI Device Instance Parameters	328
Table 2-103.	BSIM3 SOI Device Model Parameters	329
Table 2-104.	BSIM4 Device Instance Parameters	350
Table 2-105.	BSIM4 Device Model Parameters	352
Table 2-106.	Power MOSFET Device Instance Parameters	380
Table 2-107.	Power MOSFET Device Model Parameters	380
Table 2-108.	BSIM-SOI 4.6.1 Device Instance Parameters	385
Table 2-109.	BSIM-SOI 4.6.1 Device Model Parameters	386
Table 2-110.	MOSFET level 70 Output Variables	414
Table 2-111.	BSIM-SOI 4.5.0 Device Instance Parameters	416
Table 2-112.	BSIM-SOI 4.5.0 Device Model Parameters	417
Table 2-113.	MOSFET level 70450 Output Variables	443
Table 2-114.	BSIM6 Device Instance Parameters	445
Table 2-115.	BSIM6 Device Model Parameters	446
Table 2-116.	MOSFET level 77 Output Variables	472
Table 2-117.	PSP102VA legacy MOSFET 102.5 Device Instance Parameters	475
Table 2-118.	PSP102VA legacy MOSFET 102.5 Device Model Parameters	476
Table 2-119.	MOSFET level 102 Output Variables	487
Table 2-120.	PSP103VA MOSFET Device Instance Parameters	493
Table 2-121.	PSP103VA MOSFET Device Model Parameters	494
Table 2-122.	MOSFET level 103 Output Variables	522
Table 2-123.	PSP103VA MOSFET with self-heating Device Instance Parameters	529
Table 2-124.	PSP103VA MOSFET with self-heating Device Model Parameters	530
Table 2-125.	MOSFET level 1031 Output Variables	559
Table 2-126.	BSIM-CMG FINFET v111.2.1 Device Instance Parameters	566
Table 2-127.	BSIM-CMG FINFET v111.2.1 Device Model Parameters	568
Table 2-128.	MOSFET level 111 Output Variables	623
Table 2-129.	BSIM-CMG FINFET v110.0.0 Device Instance Parameters	627
Table 2-130.	BSIM-CMG FINFET v110.0.0 Device Model Parameters	628
Table 2-131.	MOSFET level 110 Output Variables	660
Table 2-132.	BSIM-CMG FINFET v107.0.0 Device Instance Parameters	664
Table 2-133.	BSIM-CMG FINFET v107.0.0 Device Model Parameters	664
Table 2-134.	MOSFET level 107 Output Variables	692
Table 2-135.	BSIM-CMG FINFET v108.0.0 Device Instance Parameters	694
Table 2-136.	BSIM-CMG FINFET v108.0.0 Device Model Parameters	694

Table 2-137. MOSFET level 108 Output Variables	725
Table 2-138. MVS ETSOI 2.0.0 Device Model Parameters	728
Table 2-139. MVS HEMT 2.0.0 Device Model Parameters	728
Table 2-140. MVSG-HV HEMT MODEL Device Instance Parameters	730
Table 2-141. MVSG-HV HEMT MODEL Device Model Parameters	730
Table 2-142. MOSFET level 2002 Output Variables	735
Table 2-143. EKV MOSFET version 2.6 Device Instance Parameters	737
Table 2-144. EKV MOSFET version 2.6 Device Model Parameters	737
Table 2-145. EKV3 MOSFET Device Instance Parameters	740
Table 2-146. EKV3 MOSFET Device Model Parameters	740
Table 2-147. L_UTSOI MOSFET Device Instance Parameters	748
Table 2-148. L_UTSOI MOSFET Device Model Parameters	748
Table 2-149. MOSFET level 10240 Output Variables	760
Table 2-150. Lossy Transmission Line Device Model Parameters	763
Table 2-151. Controlled Switch Device Model Parameters	767
Table 2-152. LIN Device Model Parameters	770
Table 2-153. Ideal Transmission Line Device Instance Parameters	773
Table 2-154. Lumped Transmission Line Device Instance Parameters	774
Table 2-155. Lumped Transmission Line Device Model Parameters	775
Table 2-156. Delay element Device Instance Parameters	777
Table 2-157. Behavioral Digital Device Instance Parameters	779
Table 2-158. Behavioral Digital Device Model Parameters	779
Table 2-159. DFF Truth-Table for DIGINITSTATE=3	781
Table 2-160. DLTCH Truth-Table for DIGINITSTATE=3	782
Table 2-161. JKFF Truth-Table for DIGINITSTATE=3	782
Table 2-162. Behavioral Digital Device Instance Parameters	784
Table 2-163. Behavioral Digital Device Model Parameters	784
Table 2-164. PowerGridBranch Device Instance Parameters	790
Table 2-165. PowerGridBusShunt Device Instance Parameters	792
Table 2-166. PowerGridTransformer Device Instance Parameters	794
Table 2-167. PowerGridGenBus Device Instance Parameters	796
Table 2-168. MemristorTEAM Device Instance Parameters	802
Table 2-169. MemristorTEAM Device Model Parameters	803
Table 2-170. MemristorYakopcic Device Instance Parameters	803
Table 2-171. MemristorYakopcic Device Model Parameters	803
Table 2-172. MemristorPEM Device Instance Parameters	804
Table 2-173. MemristorPEM Device Model Parameters	805
Table 2-174. PDE Device Model Parameters	807
Table 2-175. 1D PDE (level 1) Device Instance Parameters	807
Table 2-176. 2D PDE (level 2) Device Instance Parameters	811
Table 2-177. LAYER Composite Parameters	813
Table 2-178. NODE Composite Parameters	813
Table 2-179. NODE Composite Parameters	814
Table 2-180. DOPINGPROFILES Composite Parameters	814
Table 2-181. REGION Composite Parameters	815
Table 2-182. Description of the flatx, flaty doping parameters	816
Table 2-183. Intrinsic Carrier Concentration Parameters	818
Table 2-184. Bandgap constants	819

Table 2-185. Analytic Mobility Parameters	821
Table 2-186. Arora Mobility Parameters	822
Table 2-187. Carrier-Carrier Mobility Parameters	824
Table 2-188. Lombardi Surface Mobility Parameters	826
Table 2-189. Material workfunction values	831
Table 2-190. Electron affinities	831
Table 3-1. List of Xyce command line arguments.	835
Table 6-1. Incompatibilities with PSpice.	849
Table 6-2. Incompatibilities with Other Circuit Simulators.	851
Table 7-1. Issues for Microsoft Windows.	857
Table 8-1. Xyce ASCII rawfile format.	859
Table 8-2. Xyce binary rawfile format.	860

This page intentionally left blank.

1. INTRODUCTION

Welcome to **Xyce**[™]

The **Xyce**[™] Parallel Electronic Simulator has been written to support, in a rigorous manner, the simulation needs of the Sandia National Laboratories electrical designers. It is targeted specifically to run on large-scale parallel computing platforms but also runs well on a variety of architectures including single processor workstations. It also aims to support a variety of devices and models specific to Sandia needs.

1.1. Overview

This document is intended to complement the Xyce Users' Guide [1]. It contains comprehensive, detailed information about a number of topics pertinent to the usage of Xyce. Included in this document is a netlist reference for the input-file commands and elements supported within Xyce; a command line reference, which describes the available command line arguments for Xyce; and quick-references for users of other circuit codes, such as Orcad's PSpice [2].

1.2. How to Use this Guide

This guide is designed so you can quickly find the information you need to use Xyce. It assumes that you are familiar with basic Unix-type commands, how Unix manages applications and files to perform routine tasks (e.g., starting applications, opening files and saving your work). Note that while Windows versions of Xyce are available, they are command-line programs meant to be run under the *Command Prompt*, and are used almost identically to their Unix counterparts.

1.3. Typographical conventions

Before continuing in this Reference Guide, it is important to understand the terms and typographical conventions used. Procedures for performing an operation are generally indicated with the following typographical conventions.

Notation	Example	Description
Typewriter text	<code>mpirun -np 4</code>	Commands entered from the keyboard on the command line or text entered in a netlist.
Bold Roman Font	Set nominal temperature using the TNOM option.	SPICE-type parameters used in models, etc.
Gray Shaded Text	DEBUGLEVEL	Feature that is designed primarily for use by Xyce developers.
[text in brackets]	Xyce [options] <netlist>	Optional parameters.
<text in angle brackets>	Xyce [options] <netlist>	Parameters to be inserted by the user.
<object with asterisk>*	K1 <ind. 1> [<ind. n>*]	Parameter that may be multiply specified.
<TEXT1 TEXT2>	.PRINT TRAN + DELIMITER=<TAB COMMA SEMICOLON COLON "string">	Parameters that may only take specified values.

Table 1-1.: Xyce typographical conventions.

2. NETLIST REFERENCE

Chapter Overview

This chapter contains reference material directed towards working with circuit analyses in Xyce using the netlist interface. Included are detailed command descriptions, start-up option definitions and a list of devices supported by the Xyce netlist interface.

2.1. Netlist Commands

This section outlines the netlist commands that can be used with Xyce to setup and control circuit analysis.

2.1.1. .AC (AC Analysis)

Calculates the frequency response of a circuit over a range of frequencies.

The .AC command can specify a linear sweep, decade logarithmic sweep, octave logarithmic sweep, or a data table of multivariate values.

General Form .AC <sweep type> <points value>
 + <start frequency value> <end frequency value>

Examples .AC LIN 101 100Hz 200Hz
 .AC OCT 10 1kHz 16kHz
 .AC DEC 20 1MEG 100MEG
 .AC DATA=<table name>

 .param points=101, start=100Hz, end=200Hz
 .AC LIN {points} {start} {end}

Arguments and Options

sweep type

Must be LIN, OCT, DEC, or DATA as described below.

LIN Linear sweep

The sweep variable is swept linearly from the starting to the ending value.

OCT Sweep by octaves

The sweep variable is swept logarithmically by octaves.

DEC Sweep by decades

The sweep variable is swept logarithmically by decades.

DATA Sweep values from a table

Sweep variables are applied based on the rows of a data table. This format allows magnitude and phase to be swept in addition to frequency.

If using this format, no other arguments are needed on the .AC line.

points value

Specifies the number of points in the sweep, using an integer greater than or equal to 1.

start frequency value

end frequency value

The end frequency value must not be less than the start frequency value, and both must be greater than zero. The whole sweep must include at least one point.

Comments

AC analysis is a linear analysis. The simulator calculates the frequency response by linearizing the circuit around the DCOP bias point.

If specifying the sweep points using the DATA type, one can also sweep the magnitude and phase of an AC source, as well as the values of linear model parameters. However, unlike the use of DATA for .STEP and .DC, it is not possible to sweep nonlinear device parameters. This is because changing other nonlinear device parameters would alter the correct DCOP solution, and the AC sweep happens after the DCOP calculation in the analysis flow. To sweep a nonlinear device parameter on an AC problem, add a .STEP command to the netlist to provide an outer parametric sweep around the analysis.

A .PRINT AC must be used to get the results of the AC sweep analysis. See Section 2.1.31.

Some devices that may be expected to work in AC analysis do not at this time. This includes, but is not limited to, the lossy transmission line (LTRA) and lossless transmission line (TRA). The LTRA and TRA models will need to be replaced with lumped transmission line models (YTRANSLINE).

Power calculations (P(<device>) and W(<device>)) are not supported for any devices for AC analysis. Current variables (e.g., I(<device>)) are only supported for devices that have “branch currents” that are part of the solution vector. This includes the V, E, H and L devices. It also includes the voltage-form of the B device.

2.1.2. **.DATA (Data Table for sweeps)**

User-defined data table, which can be used to specify sweep points for `.AC`, `.DC`, `.NOISE` or `.STEP`

General Form `.DATA [<name>]`
 `+ <parameter name> [parameter name]*`
 `+ <parameter value> [parameter value]*`
 `.ENDDATA`

Examples `.data test`
 `+ r1 r2`
 `+ 8.0000e+00 4.0000e+00`
 `+ 9.0000e+00 4.0000e+00`
 `.enddata`

Arguments and Options

`name`
 Name of the data table.

`parameter name`
 Name of sweep parameter. This can be a device instance parameter, a device model parameter or a user-defined parameter specified using `.GLOBAL_PARAM` or a globally scoped `.PARAM` statement.

`parameter value`
 Value of sweep parameter for the given sweep point. This must be a double precision number. Each row of the table corresponds to a different sweep step, so multiple parameters can be changed simultaneously.

Comments

Each column of a data table corresponds to a different parameter, and each row corresponds to a different sweep point.

If using `.DATA` with `.DC` or `.STEP`, then any instance parameter, model parameter, or user-defined parameter in the global scope.

However, if using `.DATA` with `.AC` or `.NOISE`, then one can sweep the magnitude and phase of an AC source, and linear model parameters (such as resistance and capacitance) in addition to the traditional AC sweep variable, frequency. Parameters associated with nonlinear models (like transistors) are not allowed. This is because AC analysis is a linear analysis, performed after the DCOP calculation. Changing nonlinear device model parameters would result in a different DCOP solution, so changing them during the AC (or NOISE) analysis phase is not valid.

Another caveat, for both `.AC` and `.NOISE`, is that all of the frequency values in the data table must be positive. If `.DATA` is used with `.NOISE` then the integrals for the total input noise and total output noise will only be calculated, and sent to stdout, if the frequencies in the data table are monotonically increasing.

2.1.3. *.DC (DC Sweep Analysis)*

Calculates the operating point for the circuit for a range of values. Primarily, this capability is applied to independent voltage sources, but it can also be applied to most device parameters. Note that this may be repeated for multiple sources in the same *.DC* line.

The *.DC* command can specify a linear sweep, decade logarithmic sweep, octave logarithmic sweep, a list of values, or a data table of multivariate values.

2.1.3.1. Linear Sweeps

General Form `.DC [LIN] <sweep variable name> <start> <stop> <step>
+ [<sweep variable name> <start> <stop> <step>]*`

Examples `.DC LIN V1 5 25 5
.DC VIN -10 15 1
.DC R1 0 3.5 0.05 C1 0 3.5 0.5

.param start=5, stop=25, points=5
.DC {start} {stop} {points}`

Comments A `.PRINT DC` must be used to get the results of the DC sweep analysis. See Section 2.1.31.

A `.OP` command will result in a linear DC analysis if there is no *.DC* specified.

If the stop value is smaller than the start value, the step value should be negative. If a positive step value is given in this case, only a single point (at the start value) will be performed, and a warning will be emitted.

2.1.3.2. Decade Sweeps

General Form `.DC DEC <sweep variable name> <start> <stop> <points>
+ [DEC <sweep variable name> <start> <stop> <points>]*`

Examples `.DC DEC VIN 1 100 2
.DC DEC R1 100 10000 3 DEC VGS 0.001 1.0 2

.param start=1, stop=100, points=2
.DC DEC VIN {start} {stop} {points}`

Comments The stop value should be larger than the start value. If a stop value smaller than the start value is given, only a single point at the start value will be performed, and a warning will be emitted. The points value must be an integer.

2.1.3.3. Octave Sweeps

General Form .DC OCT <sweep variable name> <start> <stop> <points>
+ [OCT <sweep variable name><start> <stop> <points>]...

Examples .DC OCT VIN 0.125 64 2
 .DC OCT R1 0.015625 512 3 OCT C1 512 4096 1

 .param start=0.125, stop=64, points=2
 .DC OCT VIN {start} {stop} {points}

Comments The stop value should be larger than the start value. If a stop value smaller than the start value is given, only a single point at the start value will be performed, and a warning will be emitted. The points value must be an integer.

2.1.3.4. List Sweeps

General Form .DC <sweep variable name> LIST <val> <val> <val>*
+ [<sweep variable name> LIST <val> <val>*]*

Examples .DC VIN LIST 1.0 2.0 5.0 6.0 10.0
 .DC VDS LIST 0 3.5 0.05 VGS LIST 0 3.5 0.5
 .DC TEMP LIST 10.0 15.0 18.0 27.0 33.0

 .param val1=0, val2=3.5, val3=0.5
 .DC VDS LIST {val1} {val2} {val3}

2.1.3.5. Data Sweeps

General Form .DC DATA=<data table name>

Examples .DC data=resistorValues

 .data resistorValues
 + r1 r2
 + 8.0000e+00 4.0000e+00
 + 9.0000e+00 4.0000e+00
 .enddata

2.1.4. .DCVOLT (*Initial Condition, Bias point*)

The .DCVOLT sets initial conditions for an operating point calculation. It is identical in function to the .IC command. See section 2.1.14 for detailed guidance.

2.1.5. *.EMBEDDEDSAMPLING (Embedded Sampling)*

Calculates a full analysis (for .DC or .TRAN only) over a distribution of parameter values. Embedded sampling operates similarly to .STEP, except that the parameter values are generated from random distributions rather than sweeps, and that the loop over parameters happens at the inner-most part of the calculation, so all samples are propagated simultaneously. If used in conjunction with projection-based PCE methods, then the sample points are not based on random samples. Instead they are based on the quadrature points.

General Form `.EMBEDDEDSAMPLING`
 `+ param=<parameter name>,[parameter name]*`
 `+ type=<parameter type>,[parameter type]*`
 `+ means=<mean>,[mean]*`
 `+ std_deviations=<standard deviation>,[standard deviation]*`
 `+ lower_bounds=<lower bound>,[lower bound]*`
 `+ upper_bounds=<upper bound>,[upper bound]*`
 `+ alpha=<alpha>,[alpha]*`
 `+ beta=<beta>,[beta]*`

Examples `.EMBEDDEDSAMPLING`
 `+ param=R1`
 `+ type=normal`
 `+ means=3K`
 `+ std_deviations=1K`

 `.EMBEDDEDSAMPLING`
 `+ param=R1,R2`
 `+ type=uniform,uniform`
 `+ lower_bounds=1K,2K`
 `+ upper_bounds=5K,6K`

 `.EMBEDDEDSAMPLING`
 `+ useExpr=true`

 `.options EMBEDDEDSAMPLES numsamples=10000`

 `.options EMBEDDEDSAMPLES numsamples=25000`
 `+ OUTPUTS={R1:R},{V(1)}`
 `+ SAMPLE_TYPE=MC`

 `.options EMBEDDEDSAMPLES numsamples=1000`
 `+ MEASURES=maxSine`
 `+ SAMPLE_TYPE=LHS`

 `.options embeddedsamples numsamples=30`
 `+ covmatrix=1e6,1.0e-3,1.0e-3,4e-14`
 `+ OUTPUTS={V(1)},{R1:R},{C1:C}`

Arguments and Options

param

Names of the parameters to be sampled. This may be any of the parameters that are valid for `.STEP`, including device instance, device model, or global parameters. If more than one parameter, then specify as a comma-separated list.

type

Distribution type for each parameter. This may be uniform, normal or gamma. If more than one parameter, then specify as a comma-separated list.

means

If using normal distributions, the mean for each parameter must be specified. If more than one parameter, then specify as a comma-separated list.

std_deviations

If using normal distributions, the standard deviation for each parameter must be specified. If more than one parameter, then specify as a comma-separated list.

lower_bounds

If using uniform distributions, the lower bound must be specified. This is optional for normal distributions. If used with normal distributions, may alter the mean and standard deviation. If more than one parameter, then specify as a comma-separated list.

upper_bounds

If using uniform distributions, the upper bound must be specified. This is optional for normal distributions. If used with normal distributions, may alter the mean and standard deviation. If more than one parameter, then specify as a comma-separated list.

alpha

If using gamma distributions, the alpha value for each parameter must be specified. If more than one parameter, then specify as a comma-separated list.

beta

If using gamma distributions, the beta value for each parameter must be specified. If more than one parameter, then specify as a comma-separated list.

useExpr

If this argument is set to true, then the sampling algorithm will set up random inputs from expression operators such as `AGAUSS` and `AUNIF`. In this case it will also ignore the list of parameters on the `.EMBEDDEDSAMPLING` command line. For a complete description of expression-based random operators, see the expression documentation in section 2.2.

Comments

In addition to the `.EMBEDDEDSAMPLING` command, this analysis requires a `.options EMBEDDEDSAMPLES` command as well. The `.EMBEDDEDSAMPLING` command specifies parameters and their attributes, either using the `useExpr` option,

or with comma-separated lists. The `.options EMBEDDEDSAMPLES` command specifies analysis options, including the number of samples, the type of sampling (LHS or MC) and the outputs and/or measures for which to compute statistics. This line also allows one to specify a non-intrusive Polynomial Chaos Expansion (PCE) method (either regression or projection PCE). To see the details of the `.options EMBEDDEDSAMPLES` command, see table 2-11.

On the `.EMBEDDEDSAMPLING` command line, if not using `useExpr`, parameters and their attributes must be specified using comma-separated lists. The comma-separated lists must all be the same length.

The `.PRINT ES` command provides output based on the contents of those print-lines, and also the `NUMSAMPLES` and `OUTPUT` arguments on the `.OPTIONS EMBEDDEDSAMPLES` line. If the `OUTPUT_SAMPLE_STATS` argument on a `.PRINT ES` line is set to “true” then the statistics for the `MEAN`, `MEANPLUS`, `MEANMINUS`, `STDDEV` and `VARIANCE` will be output for each variable in the `OUTPUT` argument. If the `OUTPUT_ALL_SAMPLES` argument on a `.PRINT ES` line is set to “true” then the values of all `NUMSAMPLES` samples, for each variable requested in the `OUTPUTS` argument, will be output.

2.1.6. .END (End of Circuit)

Marks the end of netlist file.

2.1.7. .ENDS (End of Subcircuit)

Marks the end of a subcircuit definition.

2.1.8. **.FFT (FFT Analysis)**

Performs Fast Fourier Transform analysis of transient analysis output.

General Form `.FFT <ov> [NP=<value>] [WINDOW=<value>] [ALFA=<value>]
+ [FORMAT=<value>] [START=<value>] [STOP=<value>]
+ [FREQ=value] [FMIN=value] [FMAX=value]`

Examples `.FFT v(1)
.FFT v(1,2) NP=512 WINDOW=HANN
.FFT {v(3)-v(2)} START=1 STOP=2`

Arguments and Options

ov The desired solution output to be analyzed. Only one output variable can be specified on a `.FFT` line. However, multiple `.FFT` lines with the same output variable but, for example, different windowing functions may be used in a netlist. The available outputs are:

- `V(<circuit node>)` the voltage at `<circuit node>`
- `V(<circuit node>, <circuit node>)` to output the voltage difference between the first `<circuit node>` and second `<circuit node>`
- `I(<device>)` the current through a two terminal device
- `I<lead abbreviation>(<device>)` the current into a particular lead of a three or more terminal device (see the Comments, below, for details)
- `N(<device parameter>)` a specific device parameter (see the individual devices in Section 2.3 for syntax)

NP The number of points in the FFT. This value must be a power of 2. If the user-entered value is not a power of two then it will be rounded to the nearest power of 2. The minimum allowed value of NP is 4. The default value is 1024.

WINDOW

The windowing function that will be applied to the sampled waveform values. The allowed values are as follows, where table 2-1 gives their exact definitions:

- `RECT` (or `RECTANGULAR`) = rectangular window (default)
- `BART` (or `BARTLETT`) = Bartlett (triangular) window
- `BARTLETTTHANN` = Bartlett-Hann window
- `BLACK` = Blackman window
- `BLACKMAN` = “Conventional Blackman” window
- `HAMM` (or `HAMMING`) = Hamming window
- `HANN` (or `HANNING`) = Hanning window

- HARRIS (or BLACKMANHARRIS) = Blackman-Harris window
- NUTTALL = Nuttall window
- COSINE2 = Power-of-cosine window, with exponent 2.
- COSINE4 = Power-of-cosine window, with exponent 4.
- HALFCYCLESINE = Half-cycle sine window
- HALFCYCLESINE3 = Half-cycle sine window, with exponent 3.
- HALFCYCLESINE6 = Half-cycle sine window, with exponent 6.

ALFA

This parameter is supported for HSPICE compatibility. It currently has no effect though, since the GAUSS and KAISER windows are not supported.

FORMAT

The allowed values are NORM and UNORM. If NORM is selected then the magnitude values will be normalized to the largest magnitude. If UNORM is selected then the actual magnitude values will be output instead. The default value for this parameter depends on the .OPTIONS FFT FFT_MODE setting. If FFT_MODE=0, which is the default options setting, then the default value is NORM. If FFT_MODE=1 then the default value is UNORM.

START

The start time for the FFT analysis. The default value is the start time for the transient analysis. FROM is an allowed synonym for START.

STOP

The end time for the FFT analysis. The default value is the end time for the transient analysis. TO is an allowed synonym for STOP.

FREQ

The “first harmonic” of the frequencies provided in the output file. The default value for FREQ is $1/(STOP - START)$. If FREQ is given then it is rounded to the nearest integer multiple of the default value. The Xyce Users’ Guide [1] provides an example.

FMIN

This parameter can use to adjust the harmonics included in the “additional metrics” defined in Section 2.1.8.3. It has a default value of 1.

FMAX

This parameter can use to adjust the harmonics included in the “additional metrics” defined in Section 2.1.8.3. It has a default value of NP/2.

Comments

Multiple .FFT lines may be used in a netlist. All results from FFT analyses will be returned to the user in a file with the same name as the netlist file suffixed with .fftX where X is the step number.

<lead abbreviation> is a single character designator for individual leads on a device with three or more leads. For bipolar transistors these are: c (collector), b (base), e (emitter), and s (substrate). For mosfets, lead abbreviations are: d (drain), g

(gate), s (source), and b (bulk). SOI transistors have: d, g, s, e (bulk), and b (body). For PDE devices, the nodes are numbered according to the order they appear, so lead currents are referenced like I1(<device>), I2(<device>), etc.

For this analysis, the phase data is always output in degrees.

In Xyce, WINDOW=TRIANGULAR is not an allowed synonym for WINDOW=BART. This is to avoid confusion with other analysis packages such as SciPy and Matlab.

2.1.8.1. .OPTIONS FFT FFT_MODE

The setting for .OPTIONS FFT FFT_MODE is used to control whether the Xyce FFT processing and output are more compatible with HSPICE (0) or Spectre (1). This setting affects the format of the window functions, the conversion from two-sided to one-sided results, and whether the default output for the magnitude values is normalized, or not. The default setting for FFT_MODE is 0.

If FFT_MODE=0 then symmetric window functions are used. If FFT_MODE=1 then periodic window functions are used. The next subsection provides more details on that difference.

If FFT_MODE=0 then the two-sided to one-sided conversion doubles the magnitudes of the 1,2,...,NP harmonics. If FFT_MODE=1 then that conversion only doubles the magnitudes of the 1,2,...,(NP-1) harmonics.

The default value for the FORMAT parameter depends on the .OPTIONS FFT FFT_MODE setting. If FFT_MODE=0 then the default value for that parameter is NORM. If FFT_MODE=1 then the default value is UNORM.

2.1.8.2. Window Functions

Table 2-1 gives the definitions of the window functions implemented in Xyce. For HSPICE compatibility, the BLACK window type is actually the “-67 dB Three-Term Blackman-Harris window” [3] rather than the “Conventional Blackman Window” used by Spectre, Matlab and SciPy. The Conventional Blackman Window can be selected with the BLACKMAN window type instead. The definition of the BART window type [4] was chosen to match Spectre, Matlab and SciPy. The Xyce definition may differ from HSPICE.

As mentioned in the previous subsection, the choice of symmetric vs. periodic window functions can be selected via the use of .OPTIONS FFT FFT_MODE=<0 | 1>. If symmetric windows are used then $L = N - 1$ in the formulas in table 2-1, where N is the number of points in the FFT. If periodic windows are used then $L = N$.

Table 2-1. .FFT Window Function Definitions (N = Number of Points).

Value	Description	Definition
RECT	Rectangular	$w(i) = 1, \text{ for } 0 \leq i < N$
BART	Barlett [4]	$w(i) = \begin{cases} \frac{2i}{L}, & \text{if } i < 0.5 \cdot (N - 1) \\ 2 - \frac{2i}{L}, & \text{otherwise} \end{cases}$
BARTLETTTHANN	Bartlett-Hann [3]	$w(i) = 0.62 - 0.48 \cdot \left \frac{i}{L} - 0.5 \right + 0.38 \cdot \cos(2\pi \cdot (\frac{i}{L} - 0.5)), \text{ for } 0 \leq i < N$
HANN	Hanning [4]	$w(i) = \sin^2(\frac{\pi i}{L}), \text{ for } 0 \leq i < N$
HAMM	Hamming [4]	$w(i) = 0.54 - 0.46 \cdot \cos(\frac{2\pi i}{L}), \text{ for } 0 \leq i < N$

Value	Description	Definition
BLACKMAN	“Conventional Blackman window” [3]	$w(i) = 0.42 - 0.5 \cdot \cos(\frac{2\pi i}{L}) + 0.08 \cdot \cos(\frac{4\pi i}{L})$, for $0 \leq i < N$
BLACK	-67 dB Three-Term Blackman-Harris window [3]	$w(i) = 0.42323 - 0.49755 \cdot \cos(\frac{2\pi i}{L}) + 0.07922 \cdot \cos(\frac{4\pi i}{L})$, for $0 \leq i < N$
HARRIS	-92 dB Four-Term Blackman-Harris window [3]	$w(i) = 0.35875 - 0.48829 \cdot \cos(\frac{2\pi i}{L}) + 0.14128 \cdot \cos(\frac{4\pi i}{L}) - 0.01168 \cdot \cos(\frac{6\pi i}{L})$, for $0 \leq i < N$
NUTTALL	Four-Term Nuttall, Minimum Sidelobe (Blackman-Nuttall) [3]	$w(i) = 0.3635819 - 0.4891775 \cdot \cos(\frac{2\pi i}{L}) + 0.1365995 \cdot \cos(\frac{4\pi i}{L}) - 0.0106411 \cdot \cos(\frac{6\pi i}{L})$, for $0 \leq i < N$
COSINE2	Power-of-cosine window, with exponent 2	$w(i) = 0.5 - 0.5 \cdot \cos(\frac{2\pi i}{L})$, for $0 \leq i < N$
COSINE2	Power-of-cosine window, with exponent 4	$w(i) = 0.375 - 0.5 \cdot \cos(\frac{2\pi i}{L}) + 0.125 \cdot \cos(\frac{4\pi i}{L})$, for $0 \leq i < N$
HALFCYCLESINE	Half-cycle sine window	$w(i) = \sin(\frac{\pi i}{L})$
HALFCYCLESINE3	Half-cycle sine window, with exponent 3	$w(i) = \sin^3(\frac{\pi i}{L})$
HALFCYCLESINE6	Half-cycle sine window, with exponent 6	$w(i) = \sin^6(\frac{\pi i}{L})$

2.1.8.3. Additional FFT Metrics

The following additional metrics will be sent to stdout if `.OPTIONS FFT FFTOUT=1` is used in the netlist. These definitions are also used by the corresponding measure types on `.MEASURE FFT` lines.

Define the integer index of the “first harmonic” (f_0) as follows (where it has a default value of 1 and the `ROUND()` function rounds to the nearest integer):

$$f_0 = \begin{cases} \text{ROUND}(\frac{\text{FREQ}}{\text{STOP}-\text{START}}), & \text{if FREQ given} \\ 1, & \text{otherwise} \end{cases}$$

Finally, define $\text{mag}[i]$ as the magnitude of the FFT coefficient at index i , and N as the number of points in the FFT.

The Signal to Noise-plus-Distortion Ratio (SNDR) is calculated as follows, where the summation in the denominator includes all of the frequencies except for the first harmonic frequency f_0 :

$$\text{SNDR} = 20 \cdot \log_{10}(\frac{\text{mag}[f_0]}{\text{sqrt}(\sum \text{mag}[i]*\text{mag}[i])}), \text{ for } 1 \leq i \leq 0.5 \cdot N, \text{ and } i \neq f_0$$

The Effective Number of Bits (ENOB) is calculated as follows, where the units is “bits”:

$$\text{ENOB} = \frac{\text{SNDR}-1.76}{6.02}$$

For the Signal to Noise Ratio (SNR) metric define the upper frequency limit for the SNR metric as follows, with the caveat that if f_2 is less than f_0 then its value is set to f_0 :

$$f_2 = \begin{cases} \text{ROUND}(\frac{\text{FMAX}}{\text{STOP}-\text{START}}), & \text{if FMAX given} \\ 0.5 \cdot N, & \text{otherwise} \end{cases}$$

The SNR is then calculated as follows, where the summation in the denominator only uses indexes that are either not an integer-multiple of f_0 or that are greater than the upper frequency limit of f_2 . (Note: for the default case of $f_0 = 1$ and FMAX not given there are no “noise frequencies”.)

$$SNR = 20 \cdot \log_{10}\left(\frac{mag[f_0]}{\sqrt{\sum mag[i]*mag[i]}}\right), \text{ for } i > f_2 \text{ or } i \% f_0 \neq 0$$

For the Total Harmonic Distortion (THD) metric define the upper frequency limit (f_2) in the summation in the numerator as:

$$f_2 = \begin{cases} ROUND\left(\frac{FMAX}{STOP-START}\right), & \text{if FMAX given} \\ 0.5 \cdot N, & \text{otherwise} \end{cases}$$

The THD is then calculated using only the indexes that are multiples of f_0 . So, if $f_0=2$ then the summation in the numerator would only include indexes 4,6,8,etc.

$$THD = 20 \cdot \log_{10}\left(\frac{\sqrt{\sum mag[i]*mag[i]}}{mag[f_0]}\right), \text{ for } 2 \cdot f_0 \leq i \leq f_2, \text{ and } i \% f_0 = 0$$

For Spurious Free Distortion Ratio (SFDR) metric define the upper and lower frequency limits (f_2 and f_1) considered in the denominator of the calculation as:

$$f_2 = \begin{cases} ROUND\left(\frac{FMAX}{STOP-START}\right), & \text{if FMAX given} \\ 0.5 \cdot N, & \text{otherwise} \end{cases}$$

and:

$$f_1 = \begin{cases} ROUND\left(\frac{FMIN}{STOP-START}\right), & \text{if FMIN given} \\ f_0, & \text{if FMIN not given, and } f_2 \geq f_0 \\ 1, & \text{if FMIN not given, and } f_2 < f_0 \end{cases}$$

The SFDR is then calculated as:

$$SFDR = 20 \cdot \log_{10}\left(\frac{mag[f_0]}{MAX(mag[i])}\right), \text{ for } f_1 \leq i \leq f_2, \text{ and } i \neq f_0$$

2.1.8.4. Re-Measure

Xyce can re-calculate (or re-measure) the values for .FFT statements using existing Xyce output files. Section 2.1.18.4 discusses this topic in more detail for both .MEASURE and .FFT statements. One additional caveat is that FFT_ACCURATE is set to 0 during the re-measure operation. This should have no impact on the accuracy of the re-measured results if the output file was previously generated with FFT_ACCURATE set to 1.

2.1.8.5. Compatibility Between OUTPUT and FFT Options

Some .OPTIONS OUTPUT settings are incompatible with using the default setting of .OPTIONS FFT FFT_ACCURATE=1. The use of .OPTIONS OUTPUT OUTPUTTIMEPOINTS is compatible. However, the use of .OPTIONS OUTPUT INITIAL_INTERVAL is not. In that latter case, .OPTIONS FFT FFT_ACCURATE will be automatically set to 0.

2.1.9. **.FOUR (Fourier Analysis)**

Performs Fourier analysis of transient analysis output.

General Form `.FOUR <freq> <ov> [ov]*`

Examples

```
.FOUR 100K v(5)
.FOUR 1MEG v(5,3) v(3)
.FOUR 20MEG SENS
.FOUR 40MEG {v(3)-v(2)}
```

Arguments and Options

freq

The fundamental frequency used for Fourier analysis. Fourier analysis is performed over the last period (1/freq) of the transient simulation. The DC component and the first nine harmonics are calculated.

ov The desired solution output, or outputs, to be analyzed. Fourier analysis can be performed on several outputs for each fundamental frequency, **freq**. At least one output must be specified in the `.FOUR` line. The available outputs are:

- `V(<circuit node>)` the voltage at `<circuit node>`
 - `V(<circuit node>, <circuit node>)` to output the voltage difference between the first `<circuit node>` and second `<circuit node>`
 - `I(<device>)` the current through a two terminal device
 - `I<lead abbreviation>(<device>)` the current into a particular lead of a three or more terminal device (see the Comments, below, for details)
 - `N(<device parameter>)` a specific device parameter (see the individual devices in Section 2.3 for syntax)
 - `SENS` transient direct sensitivities (see Section 2.1.35 for more details about setting up the `.SENS` command)
-

Comments

Multiple `.FOUR` lines may be used in a netlist.

All results from Fourier analysis will be returned to the user in a file with the same name as the netlist file suffixed with `.four#`, where the suffixed number (#) starts at 0 and increases for multiple iterations (`.STEP` iterations) of a given simulation.

`<lead abbreviation>` is a single character designator for individual leads on a device with three or more leads. For bipolar transistors these are: c (collector), b (base), e (emitter), and s (substrate). For mosfets, lead abbreviations are: d (drain), g (gate), s (source), and b (bulk). SOI transistors have: d, g, s, e (bulk), and b (body). For PDE devices, the nodes are numbered according to the order they appear, so lead currents are referenced like `I1(<device>)`, `I2(<device>)`, etc.

For this analysis, the phase data is always output in degrees.

2.1.10. **.FUNC (Function)**

User defined functions that can be used in expressions appearing later in the same scope as the .FUNC statement (or .PARAM statement)

General Form .FUNC <name>([arg]*) [=] {<body>}
 .PARAM <name>([arg]*) = {<body>}

Examples

```
.FUNC E(x) {exp(x)}  
.FUNC DECAY(CNST) {E(-CNST*TIME)}  
.FUNC TRIWAV(x) {ACOS(COS(x))/3.14159}  
.FUNC MIN3(A,B,C) {MIN(A,MIN(B,C))}  
.FUNC SUM(A,B,C)={A+B+C}  
.PARAM SUM(A,B,C)={A+B+C}
```

Arguments and

Options

name

Function name. Functions cannot be redefined and the function name must not be the same as any of the predefined functions (e.g., SIN and SQRT).

arg The arguments to the function. .FUNC arguments cannot be node names. The number of arguments in the use of a function must agree with the number in the definition. Parameters, TIME, FREQ, and other functions are allowed in the body of function definitions. Two constants EXP and PI cannot be used as argument names. These constants are equal to e and π , respectively, and cannot be redefined.

body

May refer to other (previously defined) functions; the second example, DECAY, uses the first example, E.

Comments

The <body> of a defined function is handled in the same way as any math expression; it must be enclosed in curly braces ({}) or single quotes (').

The original keyword for user-defined functions is .FUNC. However, for simulator compatibility functions can also be specified using .PARAM. If using .FUNC, each function must get their own netlist line and the equals sign is optional. If using .PARAM, multiple functions can be specified on the same line, and the equals sign is required.

The scoping rules for functions are:

- If a .FUNC, statement is included in the main circuit netlist, then it is accessible from the main circuit and all subcircuits.
- .FUNC statements defined within a subcircuit are scoped to that subcircuit definition. So, their functions are only accessible within that subcircuit definition, as well as within “nested subcircuits” also defined within that subcircuit definition.

Additional illustrative examples of scoping are given in the “Working with Subcircuits and Models” section of the Xyce Users’ Guide [1] .

Rules for function names are as follows:

- They should start with a letter or the underscore (`_`) character, for maximal compatibility with other Spice-like simulators. The hash (`#`) at (`@`) and backtick (```) symbols also work, but they are not reserved characters.
- These arithmetic operators `% ^ & ~ * - + < > / |` should not be used anywhere in function names, as they cause problems with expression parsing.
- Parentheses (`(` or `)`), braces (`{` or `}`), commas, semi-colons, double quotes and single quotes are also not allowed.

2.1.11. **.GLOBAL (Global Node)**

The `.GLOBAL` command provides another way to designate certain nodes as global nodes, besides starting their node name with the two characters “\$G” as discussed in section 2.3.1. A typical usage of such global nodes is to define a VDD or VSS signal that all subcircuits need to be able to access, but without having to provide VSS and VDD input nodes to every subcircuit.

General Form `.GLOBAL <node1> [node2 node3 ...]`

Examples

```
.GLOBAL g1
.subckt rsub a b
Rab a b 2
* since node G1 is global, it may be used here without
* being listed on the .subckt line
Rbg G1 b 3
.ends
```

Comments The name of the global node can be any legal node name, per section 2.3.2.

2.1.12. `.GLOBAL_PARAM` (Global parameter)

User-defined global parameter that can be used in expressions throughout the netlist.

General Form `.GLOBAL_PARAM <name>=<value> [[,]<name>=<value>]*`

Examples

```
.GLOBAL_PARAM T={27+100*time}  
.GLOBAL_PARAM A=1, B=2  
.GLOBAL_PARAM C=AGAUSS(1,0.1,0.1)
```

Arguments and

Options

name

Global parameter name. Global parameters may be redefined. If the same name is used on multiple parameters, Xyce by default will use the last parameter of that name. By default, no warning will be emitted. To change this behavior, one can use the `-redefined_param` command line option, described in section 3-1.

value

The value may be a number or an expression. If it is an expression, it can be surrounded by curly braces (`{ }`), single quotes (`'`), or without delimiters. Curly braces were originally required by the Xyce parser, so if one encounters parsing difficulties, consider surrounding expression values with them.

Comments

A `.PARAM` defined in the top level netlist is equivalent to a `.GLOBAL_PARAM`, and they can be combined as needed. Thus, you may use parameters defined by `.PARAM` in expressions used to define global parameters, and you may also use global parameters in `.PARAM` definitions. However, a `.GLOBAL_PARAM` can only depend on `.PARAM` parameter from the top level circuit scope.

Like `.PARAM` parameters, `.GLOBAL_PARAM` may depend on time dependent quantities in the circuit. They may also be frequency dependent. They cannot, however, be dependent on solution variables such as voltage nodes.

Parameters defined using `.GLOBAL_PARAM` can be modified directly by various analyses, such as `.DC`, `.STEP`, `.SAMPLING` and `.EMBEDDEDSAMPLING`.

Multiple global parameters can be specified on the same netlist line. Parameters on the same line can optionally be separated using commas. If Xyce has difficulty parsing a multi-parameter `.GLOBAL_PARAM` line, consider adding commas if they are not already present.

Unlike `.PARAM`, global parameters may not be used to specify a function with arguments.

To load an external data file with time voltage pairs of data on each line into a global parameter, use this syntax:

```
.GLOBAL_PARAM extdata = {tablefile("filename")}
```

or

```
.GLOBAL_PARAM extdata = {table("filename")}
```

where `filename` would be the name of the file to load. Other interpolators that can read in a data table from a file include `fasttable`, `spline`, `akima`, `cubic`, `wodicka` and `bli`. See 2.2 for further information.

There are several reserved words that may not be used as names for parameters. These reserved words are:

- Time
- Freq
- Hertz
- Vt
- Temp
- Temper
- GMIN

Global parameters are accessible, and have the same value, throughout all levels of the netlist hierarchy. It is not legal to redefine global parameters in different levels of the netlist hierarchy. Also, global parameters can only be defined in the top level circuit scope. Parameters defined inside of subcircuits must be of the `.PARAM` type.

2.1.13. **.HB (Harmonic Balance Analysis)**

Calculates steady states of nonlinear circuits in the frequency domain.

General Form `.HB <fundamental frequencies>`

Examples `.HB 1e4`
 `.hb 1e4 2e2`

Arguments and Options `fundamental frequencies`
 Sets the fundamental frequencies for the analysis.

Comments Harmonic balance analysis calculates the magnitude and phase of voltages and currents in a nonlinear circuit. Use a `.OPTIONS HBINT` statement to set additional harmonic balance analysis options.

The `.PRINT HB` statement must be used to get the results of the harmonic balance analysis. See section 2.1.31.

Some devices that may be expected to work in HB analysis do not at this time. This includes some use cases of B sources (but not all). A time-dependent B source will not work with HB. However, a B source that is purely dependent (such as a nonlinear resistor) will work. This same guidance applies to the E,F,G, and H dependent sources.

2.1.14. **.IC (Initial Condition, Bias point)**

The `.IC/.DCVOLT` command sets initial conditions for operating point calculations. These operating point conditions will be enforced the entire way through the nonlinear solve. Initial conditions can be given for some or all of the circuit nodes.

As the conditions are enforced for the entire solve, only the nodes not specified with `.IC` statements will change over the course of the operating point calculation.

Note that it is possible to specify conditions that are not solvable. Consult the Xyce Users' Guide [1] for more guidance.

General Form

```
.IC V(<node>)=<value>
.IC <node> <value>
.DCVOLT V(<node>)=<value>
.DCVOLT <node> <value>
```

Examples

```
.IC V(2)=3.1
.IC 2 3.1
.DCVOLT V(2)=3.1
.DCVOLT 2 3.1
```

Comments

The `.IC` capability can only set voltage values, not current values.

The `.IC` capability can not be used within subcircuits to set voltage values on global nodes.

2.1.15. *.INC or .INCLUDE or .INCL (Include file)*

Include specified file in netlist.

The file name can be surrounded by single or double quotes, 'filename' or "filename", but this is not necessary. The directory for the include file is assumed to be the execution directory unless a full or relative path is given as a part of the file name.

General Form `.INC <include file name>`
 `.INCLUDE <include file name>`
 `.INCL <include file name>`

Examples `.INC models.lib`
 `.INC 'models.lib'`
 `.INC "models.lib"`
 `.INCLUDE models.lib`
 `.INCLUDE 'models.lib'`
 `.INCLUDE "path_to_library/models.lib"`

Comments If <include file name> uses an absolute path then that path is used. Otherwise, the search-path order for <include file name> is:

- Relative to the directory that contains <include file name>.
- Relative to the directory that contains the file with the top-level netlist.
- Relative to the Xyce execution directory.

2.1.16. **.LIB (Library file)**

The `.LIB` command is similar to `.INCLUDE`, in that it brings in an external file. However, it is designed to only bring in specific parts of a library file, as designated by an entry name. Note that the Xyce version of `.LIB` has been designed to be compatible with HSPICE [5], not PSpice [6].

There are two forms of the `.LIB` statement, the call and the definition. The call statement reads in a specified subset of a library file, and the definition statement defines the subsets.

2.1.16.1. **.LIB call statement**

General Form `.LIB <file name> <entry name>`

Examples

```
.LIB models.lib nom
.LIB 'models.lib' low
.LIB "models.lib" low
.LIB "path/models.lib" high
```

Arguments and Options

file name

Name of file containing netlist data. Single or double quotes (" or ') may be used around the file name.

entry name

Entry name, which determines the section of the file to be included. These sections are defined in the included file using the definition form of the `.LIB` statement.

The library file name can be surrounded by quotes (single or double), as in "path/filename" but this is not necessary. The directory for the library file is assumed to be the execution directory unless a full or relative path is given as a part of the file name. The section name denotes the section or sections of the library file to include.

If `<file name>` uses an absolute path then that path is used. Otherwise, the search-path order for `<file name>` is:

- Relative to the directory that contains `<file name>`.
- Relative to the directory that contains the file with the top-level netlist.
- Relative to the Xyce execution directory.

2.1.16.2. **.LIB definition statement**

The format given above is when the `.LIB` command is used to reference a library file; however, it is also used as part of the syntax in a library file.

General Form .LIB <entry name>
 <netlist lines>*
 .endl <entry name>

Examples

```
* Library file res.lib
.lib low
.param rval=2
r3 2 0 9
.endl low

.lib nom
.param rval=3
r3 2 0 8
.endl nom
```

Arguments and

Options

entry name

The name to be used to identify this library component. When used on a .LIB call line, these segments of the library file will be included in the calling file.

Note that for each entry name, there is a matched .lib and .endl. Any valid netlist commands can be placed inside the .lib and .endl statements. The following is an example calling netlist, which refers to the library in the examples above:

```
* Netlist file res.cir
V1 1 0 1
R 1 2 {rval}
.lib res.lib nom
.tran 1 ps 1ns
.end
```

In this example, only the netlist commands that are inside of the “nom” library will be parsed, while the commands inside of the “low” library will be discarded. As a result, the value for resistor r3 is 8, and the value for rval is 3.

2.1.17. **.LIN (Linear Analysis)**

Extracts linear transfer parameters (S-, Y- and Z-parameters) for a general multiport network. Those parameters can be output in either Touchstone format [7].

General Form .LIN [SPARCALC=<1|0>] [FORMAT=<TOUCHSTONE2|TOUCHSTONE>]
+ [LINTYPE=<S|Y|Z>] [DATAFORMAT=<RI|MA|DB>]
+ [FILE=<output filename>] [WIDTH=<print field width>]
+ [PRECISION=<floating point output precision>]

Examples .LIN
 .LIN FORMAT=TOUCHSTONE DATAFORMAT=MA FILE=foo

Arguments and Options

SPARCALC=<1|0>
If this is set to 1 then the LIN analysis is done at the frequency values specified on the .AC line. The default value is 1.

FORMAT=<TOUCHSTONE2|TOUCHSTONE>
Output file format
TOUCHSTONE Output file is in Touchstone 1 format
TOUCHSTONE2 Output file is in Touchstone 2 format. The default is TOUCHSTONE2.

LINTYPE=<S|Y|Z>
The type of parameter data (S, Y or Z) in the output file. The default is S.

DATAFORMAT=<RI|MA|DB>
Format for the S-, Y- or Z-parameter data

RI Real-imaginary format
The data is output as the real and imaginary parts for each extracted S-, Y- or Z-parameter. This is the default.

MA Magnitude-angle format
The data is output as the magnitude and the phase angle of each extracted S-, Y- or Z-parameter. For compatibility with Touchstone formats, the angle values are in degrees.

DB Magnitude(dB)-angle format
The data is output as the magnitude (in dB) and the phase angle of each extracted S-, Y- or Z-parameter. For compatibility with Touchstone formats, the angle values are in degrees.

FILE=<output filename>
Specifies the name of the file to which the output will be written. For HSPICE compatibility FILENAME= is an allowed synonym for FILE= on .LIN lines.

WIDTH=<print field width>
Controls the output width used in formatting the output.

PRECISION=<floating point precision>
Number of floating point digits past the decimal for output data.

Comments

The .LIN command line functions like a .PRINT line for the extracted S-, Y- or Z-parameter data. So, a netlist can have multiple .LIN lines with different values for the LINTYPE, DATAFORMAT and FILE arguments on each line. If there are multiple .LIN lines in the netlist, then a linear analysis will be performed if SPARCALC=1 on any of those .LIN lines.

The default filename for both Touchstone formats is <netlistName>.sNp where N is the number of “ports” (P devices) specified in the netlist.

The Xyce Touchstone output is based on the Touchstone standard [7]. So, it differs slightly from the corresponding HSPICE output. In particular, the full matrix of S-, Y- or Z-parameters is always output.

The HSPICE SPARDIGIT and FREQDIGIT arguments are not supported. Instead, the PRECISION argument is used for all of the output values.

The output of individual S-parameters via the .PRINT AC line is supported.

If the -r <raw-file-name> and -a command line options are used with .LIN with SPARCALC=1 then Xyce will exit with a parsing error.

The -o command line option can be used with .LIN. In that case, the output defaults to Touchstone 2 format and any FILE=<filename> argument on the .LIN line is ignored.

2.1.18. **.MEASURE or .MEAS (Measure output)**

The .MEASURE statement allows calculation or reporting of simulation metrics to an external file, as well as to the standard output and/or a log file. One can measure when simulated signals reach designated values, or when they are equal to other simulation values. The .MEASURE statement is supported for .TRAN, .DC, .AC and .NOISE analyses. It can be used with .STEP in all four cases. For HSPICE compatibility, .MEAS is an allowed synonym for .MEASURE.

The syntaxes for the .MEASURE statements are shown below. The AVG, DERIV, EQN, ERR, ERR1, ERR2, FIND-AT, FIND-WHEN, INTEG, MIN, MAX, PP, RMS, WHEN and TRIG-TARG measures are supported for all four “measure modes” (TRAN, AC, DC and NOISE). Note that each measure type (e.g., MAX) may be listed twice. This is because only a subset of the allowed “qualifiers” (e.g., FROM and TO) may be supported for the AC, DC and NOISE measure modes.

The ERROR measure is Xyce-specific, and is supported for TRAN, AC, DC and NOISE measure modes. The DUTY, FREQ, FOUR, OFF_TIME and ON_TIME measures are also Xyce-specific, and are only supported for TRAN measure mode.

General Form

```
.MEASURE TRAN <result name> AVG <variable>
+ [MIN_THRESH=<value>] [MAX_THRESH=<value>]
+ [FROM=<time>] [TO=<time>] [TD=<time>]
+ [DEFAULT_VAL=<value>] [PRECISION=<value>] [PRINT=<value>]

.MEASURE TRAN <result name> DERIV <variable> AT=<value>
+ [MINVAL=<value>] [DEFAULT_VAL=<value>]
+ [PRECISION=<value>] [PRINT=<value>]

.MEASURE TRAN <result name> DERIV <variable>
+ WHEN <variable>=<variable2>|<value>
+ [MINVAL=<value>] [FROM=<value>] [TO=<value>] [TD=<value>]
+ [RISE=r|LAST] [FALL=f|LAST] [CROSS=c|LAST]
+ [DEFAULT_VAL=<value>] [PRECISION=<value>] [PRINT=<value>]

.MEASURE TRAN <result name> DUTY <variable>
+ [ON=<value>] [OFF=<value>] [MINVAL=<value>]
+ [FROM=<value>] [TO=<value>] [TD=<value>]
+ [DEFAULT_VAL=<value>] [PRECISION=<value>] [PRINT=<value>]

.MEASURE TRAN <result name> EQN <variable>
+ [FROM=<value>] [TO=<value>] [TD=<value>]
+ [DEFAULT_VAL=<value>] [PRECISION=<value>] [PRINT=<value>]

.MEASURE TRAN <result name> <ERR|ERR1|ERR2>
+ <variable1> <variable2> [FROM=<value>] [TO=<value>]
+ [MINVAL=<value>] [IGNOR|YMIN=<value>] [YMAX=<value>]
+ [DEFAULT_VAL=<value>] [PRECISION=<value>] [PRINT=<value>]

.MEASURE TRAN <result name> ERROR <variable> FILE=<value>
+ INDEPVARCOL=<value> DEPVARCOL=<value> [COMP_FUNCTION=<value>]
```

```

+ [DEFAULT_VAL=<value>] [PRECISION=<value>] [PRINT=<value>]

.MEASURE TRAN <result name> FIND <variable> AT=<value>
+ [MINVAL=<value>] [DEFAULT_VAL=<value>]
+ [PRECISION=<value>] [PRINT=<value>]

.MEASURE TRAN <result name> FIND <variable>
+ WHEN <variable>=<variable2>|<value>
+ [FROM=<value>] [TO=<value>] [TD=<value>]
+ [RISE=r|LAST] [FALL=f|LAST] [CROSS=c|LAST]
+ [MINVAL=<value>] [DEFAULT_VAL=<value>]
+ [PRECISION=<value>] [PRINT=<value>]

.MEASURE TRAN <result name> FOUR <variable> AT=freq
+ [NUMFREQ=<value>] [GRIDSIZE=<value>]
+ [FROM=<value>] [TO=<value>] [TD=<value>]
+ [DEFAULT_VAL=<value>] [PRECISION=<value>] [PRINT=<value>]

.MEASURE TRAN <result name> FREQ <variable>
+ [ON=<value>] [OFF=<value>] [MINVAL=<value>]
+ [FROM=<value>] [TO=<value>] [TD=<value>]
+ [DEFAULT_VAL=<value>] [PRECISION=<value>] [PRINT=<value>]

.MEASURE TRAN <result name> INTEG <variable>
+ [FROM=<value>] [TO=<value>] [TD=<value>]
+ [DEFAULT_VAL=<value>] [PRECISION=<value>] [PRINT=<value>]

.MEASURE TRAN <result name> MAX <variable>
+ [FROM=<value>] [TO=<value>] [TD=<value>]
+ [RISE=r|LAST] [FALL=f|LAST] [CROSS=c|LAST] [RFC_LEVEL=<value>]
+ [DEFAULT_VAL=<value>] [PRECISION=<value>]
+ [PRINT=<value>] [OUTPUT=<value>]

.MEASURE TRAN <result name> MIN <variable>
+ [FROM=<value>] [TO=<value>] [TD=<value>]
+ [RISE=r|LAST] [FALL=f|LAST] [CROSS=c|LAST] [RFC_LEVEL=<value>]
+ [DEFAULT_VAL=<value>] [PRECISION=<value>]
+ [PRINT=<value>] [OUTPUT=<value>]

.MEASURE TRAN <result name> OFF_TIME <variable>
+ [OFF=<value>] [MINVAL=<value>]
+ [FROM=<value>] [TO=<value>] [TD=<value>]
+ [DEFAULT_VAL=<value>] [PRECISION=<value>] [PRINT=<value>]

.MEASURE TRAN <result name> ON_TIME <variable>
+ [ON=<value>] [MINVAL=<value>]
+ [FROM=<value>] [TO=<value>] [TD=<value>]
+ [DEFAULT_VAL=<value>] [PRECISION=<value>] [PRINT=<value>]

```

```
.MEASURE TRAN <result name> PP <variable>
+ [FROM=<value>] [TO=<value>] [TD=<value>]
+ [RISE=r|LAST] [FALL=f|LAST] [CROSS=c|LAST] [RFC_LEVEL=<value>]
+ [DEFAULT_VAL=<value>] [PRECISION=<value>] [PRINT=<value>]
```

```
.MEASURE TRAN <result name> RMS <variable>
+ [FROM=<value>] [TO=<value>] [TD=<value>]
+ [DEFAULT_VAL=<value>] [PRECISION=<value>] [PRINT=<value>]
```

```
.MEASURE TRAN <result name> WHEN <variable>=<variable2>|<value>
+ [FROM=<value>] [TO=<value>] [TD=<value>]
+ [RISE=r|LAST] [FALL=f|LAST] [CROSS=c|LAST]
+ [MINVAL=<value>] [DEFAULT_VAL=<value>]
+ [PRECISION=<value>] [PRINT=<value>]
```

```
.MEASURE <AC|DC|NOISE|TRAN> <result name>
+ TRIG <variable1>=<variable2>|<value>
+ [TD=<val>] [RISE=r] [FALL=f] [CROSS=c]
+ TARG <variable3>=<variable4>|<value>
+ [TD=<val>] [RISE=r] [FALL=f] [CROSS=c]
+ [MINVAL=<value>] [DEFAULT_VAL=<value>]
+ [PRECISION=<value>] [PRINT=<value>]
```

```
.MEASURE <AC|DC|NOISE|TRAN> <result name>
+ TRIG AT=<value> TARG AT=<value>
+ [MINVAL=<value>] [DEFAULT_VAL=<value>]
+ [PRECISION=<value>] [PRINT=<value>]
```

```
.MEASURE TRAN <result name>
+ TRIG <variable1> FRAC_MAX=<value>
+ [RISE=r] [FALL=f] [CROSS=c]
+ [FROM=<value>] [TO=<value>] [TD=<value>]
+ TARG <variable2> FRAC_MAX=<value>
+ [RISE=r] [FALL=f] [CROSS=c]
+ [FROM=<value>] [TO=<value>] [TD=<value>]
+ [MINVAL=<value>] [DEFAULT_VAL=<value>]
+ [PRECISION=<value>] [PRINT=<value>]
```

```
.MEASURE <AC|DC|NOISE> <result name> AVG <variable>
+ [FROM=<value>] [TO=<value>]
+ [DEFAULT_VAL=<value>] [PRECISION=<value>] [PRINT=<value>]
```

```
.MEASURE <AC|DC|NOISE> <result name> DERIV <variable> AT=<value>
+ [MINVAL=<value>] [DEFAULT_VAL=<value>]
+ [PRECISION=<value>] [PRINT=<value>]
```

```
.MEASURE <AC|DC|NOISE> <result name> DERIV <variable>
```



```

+ WHEN <variable>=<variable2>|<value>
+ [MINVAL=<value>] [FROM=<value>] [TO=<value>]
+ [RISE=r|LAST] [FALL=f|LAST] [CROSS=c|LAST]
+ [DEFAULT_VAL=<value>] [PRECISION=<value>] [PRINT=<value>]

.MEASURE <AC|DC|NOISE> <result name> EQN <variable>
+ [FROM=<value>] [TO=<value>]
+ [DEFAULT_VAL=<value>] [PRECISION=<value>] [PRINT=<value>]

.MEASURE <AC|DC|NOISE> <result name> <ERR|ERR1|ERR2>
+ <variable1> <variable2> [FROM=<value>] [TO=<value>]
+ [MINVAL=<value>] [IGNOR|YMIN=<value>] [YMAX=<value>]
+ [DEFAULT_VAL=<value>] [PRECISION=<value>] [PRINT=<value>]

.MEASURE <AC|DC|NOISE> <result name> ERROR <variable>
+ FILE=<value> [DEPVARCOL=<value>] [COMP_FUNCTION=<value>]
+ [DEFAULT_VAL=<value>] [PRECISION=<value>] [PRINT=<value>]

.MEASURE <AC|DC|NOISE> <result name> FIND <variable> AT=<value>
+ [MINVAL=<value>] [DEFAULT_VAL=<value>]
+ [PRECISION=<value>] [PRINT=<value>]

.MEASURE <AC|DC|NOISE> <result name> FIND <variable>
+ WHEN <variable>=<variable2>|<value>
+ [FROM=<value>] [TO=<value>]
+ [RISE=r|LAST] [FALL=f|LAST] [CROSS=c|LAST]
+ [MINVAL=<value>] [DEFAULT_VAL=<value>]
+ [PRECISION=<value>] [PRINT=<value>]

.MEASURE <AC|DC|NOISE> <result name> INTEG <variable>
+ [FROM=<value>] [TO=<value>]
+ [DEFAULT_VAL=<value>] [PRECISION=<value>] [PRINT=<value>]

.MEASURE <AC|DC|NOISE> <result name> MAX <variable>
+ [FROM=<value>] [TO=<value>]
+ [DEFAULT_VAL=<value>] [PRECISION=<value>]
+ [PRINT=<value>] [OUTPUT=<value>]

.MEASURE <AC|DC|NOISE> <result name> MIN <variable>
+ [FROM=<value>] [TO=<value>]
+ [DEFAULT_VAL=<value>] [PRECISION=<value>]
+ [PRINT=<value>] [OUTPUT=<value>]

.MEASURE <AC|DC|NOISE> <result name> PP <variable>
+ [FROM=<value>] [TO=<value>]
+ [DEFAULT_VAL=<value>] [PRECISION=<value>] [PRINT=<value>]

.MEASURE <AC|DC|NOISE> <result name> RMS <variable>

```

```

+ [FROM=<value>] [TO=<value>]
+ [DEFAULT_VAL=<value>] [PRECISION=<value>] [PRINT=<value>]

.MEASURE <AC|DC|NOISE> <result name>
+ WHEN <variable>=<variable2>|<value>
+ [FROM=<value>] [TO=<value>]
+ [RISE=r|LAST] [FALL=f|LAST] [CROSS=c|LAST]
+ [MINVAL=<value>] [DEFAULT_VAL=<value>]
+ [PRECISION=<value>] [PRINT=<value>]

```

Examples

```

.MEASURE TRAN hit1_75 WHEN V(1)=0.75 MINVAL=0.02
.MEASURE TRAN hit2_75 WHEN V(1)=0.75 MINVAL=0.08 RISE=2
.MEASURE TRAN avgAll AVG V(1)
.MEASURE TRAN dutyAll DUTY V(1) ON=0.75 OFF=0.25
.MEASURE DC maxV1 MAX V(1)
.MEAS DC minV2 MIN V(2)
.MEASURE AC maxV1R MAX VR(1)
.MEASURE NOISE maxnoise MAX ONOISE

```

Arguments and Options

result name

Measured results are reported to the output and log file. Additionally, for TRAN measures, the results are stored in files called `circuitFileName.mt#`, where the suffixed number (#) starts at 0 and increases for multiple iterations (.STEP iterations) of a given simulation. Each line of this file will contain the measurement name, `<result name>`, followed by its value for that run. The `<result name>` must be a legal Xyce character string. For DC measures, the results are stored in the files `circuitFileName.ms#`, while AC and NOISE measures use the files `circuitFileName.ma#`.

If multiple measures are defined with the same `<result name>` then Xyce uses the last such definition, and issues warning messages about (and discards) any previous measure definitions with the same `<result name>`.

measure type

AVG, DERIV, DUTY, EQN, ERR, ERR1, ERR2, ERROR, FIND, FREQ, FOUR, INTEG, MAX, MIN, OFF_TIME, ON_TIME, PP, RMS, WHEN, TRIG, TARG

The third argument specifies the type of measurement or calculation to be done. The only exception is the TARG clause which comes later in the argument list, after the TRIG clause has been specified.

By default, the measurement is performed over the entire simulation. The calculations can be limited to a specific measurement window by using the qualifiers FROM, TO, TD, RISE, FALL, CROSS and MINVAL, which are explained below.

The supported measure types and their definitions are:

- AVG** Computes the arithmetic mean of <variable> for the simulation, or within the extent of the measurement window. The measurement window can be limited with the qualifiers FROM, TO and TD for TRAN measures, and with FROM and TO for AC, DC and NOISE measures.
- DERIV** Computes the derivative of <variable> at a user-specified time (by using the AT qualifier) or when a user-specified condition occurs (by using the WHEN qualifier). If the WHEN qualifier is used then the measurement window can be limited with the qualifiers FROM, TO, RISE, FALL and CROSS for all measure modes. In addition, the TD qualifier is supported for TRAN measures. The MINVAL qualifier is used as a comparison tolerance for both AT and WHEN. For HSPICE compatibility, DERIVATIVE is an allowed synonym for DERIV.
- DUTY** Fraction of time that <variable> is greater than ON and does not fall below OFF either for the entire simulation, or the measurement window. The qualifier MINVAL is used as a tolerance on the ON and OFF values, so that the thresholds become (ON – MINVAL) and (OFF – MINVAL). The measurement window can be limited with the qualifiers FROM, TO, and TD for TRAN measures.
- EQN** Calculates the value of <variable> during the simulation. The measurement window can be limited with the qualifiers FROM, TO and TD for TRAN measures, and with FROM and TO for AC, DC and NOISE measures. As noted in the “Additional Examples” subsection, the variable can use the results of other measure statements.
- ERRx** Calculates the error between two simulation variables, where the ERR1 and ERR2 functions (and the use of the MINVAL, YMIN and YMAX qualifiers in those functions) are defined further in the “Error Functions (ERR1 and ERR2)” subsection. The ERR measure type is a synonym for the ERR1 measure type. The measurement window can be limited with the qualifiers FROM and TO.
- ERROR** Calculates the norm between the measured waveform and a “comparison waveform” specified in a file. The supported norms are L1, L2 and INFNORM. The default norm is the L2 norm.
- FIND-AT** Returns the value of <variable> at the time when the AT clause is satisfied. The AT clause is described in more detail later in this list.
- FIND-WHEN** Returns the value of <variable> at the time when the WHEN clause is satisfied. The WHEN clause is described in more detail later in this list.
- FOUR** Calculates the fourier transform of the transient waveform for <variable>, given the fundamental frequency AT. All frequencies output by the measure will be multiples of that fundamental frequency, and will always start at that fundamental frequency. The values of the DC component and the first NUMFREQ-1 harmonics are determined using an interpolation of GRIDSIZE points. The default values for NUMFREQ and GRIDSIZE are 10 and 200, respectively. The measurement window can be limited with the qualifiers FROM, TO and TD for TRAN

measures. For this measure, the phase data is always output in degrees.

FREQ An estimate of the frequency of <variable>, found by cycle counting during the simulation. Cycles are defined through the values of ON and OFF with MINVAL being used as a tolerance so that the thresholds becomes (ON – MINVAL) and (OFF + MINVAL). The measurement window can be limited with the qualifiers FROM, TO and TD for TRAN measures.

INTEG Calculates the integral of outVal through second order numerical integration. The integration window can be limited with the qualifiers FROM, TO and TD for TRAN measures, and with FROM and TO for AC, DC and NOISE measures. For HSPICE compatibility, INTEGRAL is an allowed synonym for INTEG.

MAX Returns the maximum value of <variable> during the simulation. The measurement window can be limited with the qualifiers FROM, TO, TD, RISE, FALL and CROSS for TRAN measures, and with FROM and TO for AC, DC and NOISE measures.

MIN Returns the minimum value of <variable> during the simulation. The measurement window can be limited with the qualifiers FROM, TO, TD, RISE, FALL and CROSS for TRAN measures, and with FROM and TO for AC, DC and NOISE measures.

OFF_TIME Returns the time that <variable> is below OFF during the simulation or measurement window, normalized by the number of cycles of the waveform during the simulation or measurement window. OFF uses MINVAL as a tolerance, and the threshold becomes (OFF + MINVAL). The measurement window can be limited with the qualifiers FROM, TO and TD for TRAN measures.

ON_TIME Returns the time that <variable> is above ON during the simulation or measurement window, normalized by the number of cycles of the waveform during the simulation or measurement window. ON uses MINVAL as a tolerance, and the threshold becomes (ON – MINVAL). The measurement window can be limited with the qualifiers FROM, TO and TD for TRAN measures.

PP Returns the difference between the maximum value and the minimum value <variable> during the simulation. The measurement window can be limited with the qualifiers FROM, TO, TD, RISE, FALL and CROSS for TRAN measures, and with FROM and TO for AC, DC and NOISE measures.

RMS Computes the root-mean-squared value of <variable> during the simulation, which is defined as "the square root of the area under the <variable> curve, divided by the period of interest". The measurement window can be limited with the qualifiers FROM, TO and TD for TRAN measures, and with FROM and TO for AC, DC and NOISE measures.

TRIG

TARG Measures the time between a trigger event and a target event. The trigger is specified with TRIG <variable₁>=<variable₂> or TRIG

<variable₁>=<value> or TRIG AT=<value>. The target is then specified as TARG <variable₃>=<variable₄> or TARG <variable₃>=<value>. or TARG AT=<value>. It is also possible to use this measure to find a rise time for variable when the rise time is defined as the time to go from some small fraction of the maxima to some other fraction of the maxima. For example, the syntax for finding a rise time from 10% to 90% of the maxima is:
TRIG V(node) FRAC_MAX=0.1 TARG V(node) FRAC_MAX=0.9

WHEN Returns the time (or frequency or DC sweep value) when <variable> reaches <variable₂> or the constant value, value. The measurement window can be limited with the qualifiers FROM, TO, RISE, FALL and CROSS for all measure modes. In addition, the TD qualifier is supported for TRAN measures. The qualifier MINVAL acts as a tolerance for the comparison. For example when <variable₂> is specified, the comparison used is when <variable> = <variable₂> ± MINVAL or when a constant, value is given: <variable> = value ± MINVAL. If the conditions specified for finding a given value were not found during the simulation then the measure will return the default value of 0. The user may change this default value with the DEFAULT_VAL qualifier described below. Note: The use of FIND and WHEN in one measure statement is also supported.

variable
variable_n
value

These quantities represents the test for the stated measurement. <variable> is a simulation quantity, such as a voltage or current. One can compare it to another simulation variable or a fixed quantity. Additionally, the <variable> may be a Xyce expression delimited by { } brackets. As noted above, an example is V(1)=0.75

AT=value

A time *at which* the measurement calculation will occur. This is used by the DERIV and FIND measures and the TRIG clause. Note that ill-considered use of the FROM, TO, TD and AT qualifiers in the same TRIG-TARG measure statement can cause an empty measurement window, and thus a failed measure. Finally, the FROM and TO qualifiers take precedence over the AT qualifier for DERIV and FIND measures.

FROM=value

A time (or frequency or DC sweep value) *after which* the measurement calculation will start. For DC measures, this qualifier uses the first variable on the .DC line.

TO=value

A time (or frequency or DC sweep value) *at which* the measurement calculation will stop. For DC measures, this qualifier uses the first variable on the .DC line.

TD=value

A time delay before which this measurement should be taken or checked. Note that ill-considered use of both FROM and TO qualifiers and a TD qualifier in the same measure statement can cause an empty measurement window, and thus a failed measure.

MIN_THRESH=value

A minimum threshold value above which the measurement calculation will be done and below which it will not be done. This is only used by the AVG measure.

MAX_THRESH=value

A maximum threshold value above which the measurement calculation will not be done and below which it will be done. This is only used by the AVG measure.

RISE=r | LAST

The number of rises after which the measurement should be checked. If LAST is specified, then the last rise found in the simulation will be used. It is recommended that only one of the qualifiers RISE, FALL or CROSS be used in a given measure statement. The exception is TRIG-TARG measures. In that case, different RISE, FALL and CROSS criteria can be specified for TRIG and TARG.

FALL=f | LAST

The number of falls after which the measurement should be checked. If LAST is specified, then the last fall found in the simulation will be used.

CROSS=c | LAST

The number of zero crossings after which the measurement should be checked. If LAST is specified, then the last zero crossing found in the simulation will be used.

RFC_LEVEL=value

The level used to calculate rises, falls and crosses when the “level-crossing” mode is used by measure types that do not support the WHEN qualifier. So, RFC_LEVEL is used by the MAX, MIN and PP measures. Its usage is discussed further in the subsection on “Rise, Fall and Cross Qualifiers”.

MINVAL=value

For the DERIV, DUTY, FIND, FREQ, OFF_TIME, ON_TIME and WHEN measures, this is allowed difference between outVal and the variable to which it is being compared. This has a default value of 1.0e-12. One may need to specify a larger value to avoid missing the test condition in a transient run. The descriptions of those seven measures detail how MINVAL is used by each measure. For the ERR1 and ERR2 measures, if the absolute value of <variable₁> is less than MINVAL, then MINVAL replaces the value of the denominator of the ERR1 or ERR2 expression. For all measure types, that support the FROM, TO and/or TD qualifiers, MINVAL also functions as a relative tolerance for the comparison of the simulation time (or sweep value) to the bounds of the measurement window. This allows for numerical-roundoff errors if the FROM, TO and/or TD qualifiers are expressions.

YMIN=value

If the absolute value of <variable₁> in ERR1 or ERR2 measure is less than the YMIN value then the ERR1 or ERR2 calculation does not consider that point. The default is 1.0e-15. IGNOR and IGNORE are synonyms for YMIN.

YMAX=value

If the absolute value of <variable₁> in ERR1 or ERR2 measure is greater than YMAX value then the ERR1 or ERR2 calculation does not consider that point. The default is 1.0e15.

FRAC_MAX=value

A fractional value of the maximum value of <variable>. This is useful for ensemble runs where the maximum value of a waveform is not known in advance. FRAC_MAX is used by the TRIG and TARG measures for TRAN measure mode, only.

ON=value

The value at which a signal is considered to be “on” for FREQ, DUTY and ON_TIME measure calculations. This has a default value of 0.

OFF=value

The value at which a signal is considered to be “off” for FREQ, DUTY and ON_TIME measure calculations. This has a default value of 0.

DEFAULT_VAL=value

If the conditions specified for finding a given measure’s value are not found during the simulation then the measure will return a default value of 0. As examples, a measure will fail if the condition specified by a WHEN or AT qualifier is not found. It will also fail if the user specifies a set of FROM, TO and TD values for a given measure that yields an empty measurement interval. The default value for a given measure is settable by the user by adding the qualifier DEFAULT_VAL=<retval> on that measure line. The .OPTIONS MEASURE DEFAULT_VAL=<value> setting can be used to set the default value of all of the measures in the netlist. The measure value in the standard output or log file will always be FAILED. The measure value in the circuitFileName.mt# (or circuitFileName.ms# or circuitFileName.ma#) files will also be FAILED by default (.OPTIONS MEASURE MEASFAIL=1). If .OPTIONS MEASURE MEASFAIL=0 is used in the netlist then the measure value in the output file will be the default value. See Section 2.1.25 for more details on the .OPTIONS settings. As a final note, the FOUR measure is a special case since it produces multiline output. Failed FOUR measures will be reported as FAILED in the circuitFileName.mt# (or circuitFileName.ms# or circuitFileName.ma#) files, irrespective of the various MEASFAIL and DEFAULT_VAL settings.

PRECISION=value

The default precision for .MEASURE output is 6 digits after the decimal point. This argument provides a user configurable precision for a given .MEASURE statement that applies to both the .mt# (or .ms# or .ma#) files and standard output. If .OPTIONS MEASURE MEASDGT=<val> is given in the netlist then that value overrides the PRECISION parameters given on individual

.MEASURE lines.

PRINT=value

This parameter controls where the .MEASURE output appears. The default is ALL, which produces measure output in both the .mt# (or .ms# or .ma#) file and to the standard output. A value of STDOUT only produces measure output to standard output, while a value of NONE suppresses the measure output to both the .mt# (or .ms# or .ma#) file and standard output. The subsection on “Suppressing Measure Output” gives examples and also discusses the interactions of this parameter with .OPTIONS MEASURE MEASPRINT=<val>.

OUTPUT=value

This parameter is only supported for the MAX and MIN measures. The default is VALUE. For TRAN measures, a value of VALUE will print the maximum (or minimum) value to the .mt# file. A value of TIME will print the time of the maximum (or minimum) value to the .mt# file. For DC measures, a value of SV will output the value of the first variable on the .DC line to the .ms# file. For AC and NOISE measures, a value of FREQ will print the frequency at which the maximum (or minimum) value occurs to the .ma# file. This parameter does not affect the descriptive output that is printed to the standard output. The “Additional Examples” subsection gives an example for the MAX measure.

VAL=value

This parameter is only implemented for the TRIG and TARG measures. It is not the preferred Xyce syntax. It is only supported for HSPICE compatibility (see that subsection, below, for details).

GOAL=value

This parameter is not implemented in Xyce, but is included for compatibility with HSPICE netlists.

WEIGHT=value

This parameter is not implemented in Xyce, but is included for compatibility with HSPICE netlists.

FILE=value

The filename for the “comparison file” used for the ERROR measure. This qualifier is required for the ERROR measure.

INDEPVARCOL=value

The column index, in the “comparison file”, of the independent variable (e.g, the simulation time or frequency) used in an ERROR measure. This qualifier is required for the TRAN, AC and NOISE measure modes. For those modes, the INDEPVARCOL and DEPVARCOL qualifiers must have different values. The INDEPVARCOL qualifier is not used for DC mode ERROR measures, and will be “silently ignored” in that case. Finally, note that the column indices in Xyce output files start with 0.

DEPVARCOL=value

The column index, in the “comparison file”, of the dependent variable used in an ERROR measure. This qualifier is required for the ERROR measure for all

four measure modes (TRAN, AC, DC and NOISE). For the TRAN, AC and NOISE measure modes, the DEPVARCOL and INDEPVARCOL qualifiers must have different values. Finally, note that the column indices in Xyce output files start with 0.

COMP_FUNCTION=value

This is the norm used by the ERROR measure to compare the simulation values for the measured variable with the corresponding values in the “comparison file” specified with the FILE qualifier. The allowed values are L1NORM, L2NORM and INFNORM. Any other values will default to L2NORM. This qualifier is optional for the ERROR measure, and has a default value of L2NORM. The descriptive output for each ERROR measure, that is printed to standard output, will explicitly state which norm was used for each ERROR measure.

2.1.18.1. Measure Output

As previously mentioned, measured results are reported to the output and log file. Additionally, for TRAN measures, the results are stored in files called `circuitFileName.mt#`, where the suffixed number (#) starts at 0 and increases for multiple iterations (.STEP iterations) of a given simulation. For DC measures, the results are stored in the files `circuitFileName.ms#`, while AC and NOISE measures use the files `circuitFileName.ma#`.

A user-defined measure can also be output at each time-step via inclusion in a .PRINT command. For example, this netlist excerpt outputs the integral of V(1) at each time step. The measure value TINTV1 is then also output at the end of the simulation to both the standard output and the .mt# (or .ms# or .ma#) files.

```
.MEASURE TRAN TINTV1 INTEG V(1)
.PRINT TRAN FORMAT=NOINDEX V(1) TINTV1
```

The output for successful and failed measures to the standard output (and log files) provides more information than just the measure’s calculated values. As an example, for a successful and failed MAX measure the standard output would be:

```
MAXVAL = 0.999758 at time = 0.000249037
Measure Start Time= 0 Measure End Time= 0.001
```

```
Netlist warning: MAXFAIL failed. TO value < FROM value
MAXFAIL = FAILED at time = 0
Measure Start Time= 1 Measure End Time= 0.001
```

In general, information on the measurement window, the time(s) that the measure’s value(s) were calculated and a possible cause for a failed measure are output to standard output for all measures except for FOUR. This information is similar, but not identical, to HSPICE’s verbose output. For a failed FOUR measure, the standard output will have “FAILED”, but there may be less information provided as to why the FOUR measure failed.

In this example, the `circuitFileName.mt#` file would have the following output:

```
MAXVAL = 0.999758
MAXFAIL = -1
```

2.1.18.2. Measurement Windows

There is an implicit precedence when multiple qualifiers are specified to limit the measurement window for a given `.MEASURE` statement for `TRAN` measures. In general, Xyce first considers the time-window criteria of the `FROM`, `TO` and `TD` qualifiers. If the simulation time is within that user-specified time-window then the `RISE`, `FALL`, `CROSS` are qualifiers are counted and/or the `TRIG`, `TARG` and `WHEN` qualifiers are evaluated.

The following netlist excerpt shows simple examples where the `.MEASURE` statement may return the default value because the measure “failed”. For `riseSine`, this may occur because `V(1)` never has an output value of 1.0 because of the time steps chosen by Xyce. So, careful selection of the threshold values in `WHEN`, `TRIG` and `TARG` clauses may be needed in some cases. For `fallPulseFracMax`, the simulation interval is too short and the `TARG` value of 0.3 for `V(2)` is not reached within the specified one-second simulation time. For `maxSine`, the `FROM`, `TO` and `TD` values yield an empty time interval, which is typically an error in netlist entry.

```
VS 1 0 SIN(0 1.0 0.5 0 0)
VP 2 0 PULSE( 0 10 0.2 0.2 0.2 0.5 2)
R1 1 0 100K
R2 2 0 100K
.TRAN 0 1
.PRINT TRAN FORMAT=NOINDEX V(1) V(2)
.MEASURE TRAN riseSine TRIG V(1)=0 TARG V(1)=1.0
.MEASURE TRAN fallPulseFracMax TRIG V(2) FRAC_MAX=0.97
+ TARG V(2) FRAC_MAX=0.03
.MEASURE TRAN maxSine MAX V(1) FROM=0.2 TO=0.25 TD=0.5
```

The intent in Xyce is for the measurement window to be the intersection of the `FROM-TO` and `TD` windows, if both are specified. As noted above, the use of both `FROM-TO` and `TD` windows can lead to an empty measurement window. So, that usage is not recommended.

2.1.18.3. Expression Support

These measure “qualifiers” (`TO`, `FROM`, `TD`, `RISE`, `FALL`, `CROSS`, `AT`, `OFF`, `ON`, `DEFAULT_VAL` and `VAL`) support expressions. The caveat is that the expression must evaluate to a constant at the time that each measure object is made. So, that expression can not depend on solution variables or lead currents. This limitation matches HSPICE. It also can not depend on a global parameter. Finally, it can not depend on another measure’s value, which is an allowed syntax in HSPICE.

Simple examples of allowed syntaxes for qualifiers are as follows, where all three measures will get the same answer:

```
.PARAM t1=0.2
.PARAM t2=0.3
.MEASURE TRAN M1 PP V(1) FROM='0.1+0.2'
```

```
.MEASURE TRAN M2 PP V(1) FROM={0.1+t1}
.MEASURE TRAN M3 PP V(1) TO={t2}
```

Expressions should also work in FIND-WHEN, WHEN and TRIG-TARG measures. The preferred Xyce syntax with curly braces and the three legal HSPICE syntaxes for expressions should all work. However, note that the two HSPICE expression syntaxes shown below are only legal in Xyce .MEASURE statements.

```
.PARAM a1=0.1
.PARAM a2=0.7
.MEASURE TRAN M4 FIND V(2) WHEN V(1)={a1}
.MEASURE TRAN M4PAR FIND V(2) WHEN V(1)=PAR('a1') ; HSPICE exp. syntax
.MEASURE TRAN M4PAREN FIND V(2) WHEN V(1)=('a1') ; HSPICE exp. syntax
.MEASURE TRAN M5 WHEN V(1)={a1}
.MEASURE TRAN M6 TRIG {v(1)-0.1} VAL={a1} TARG {v(1)-0.5} VAL={a2}
```

2.1.18.4. Re-Measure

Xyce can re-calculate (or re-measure) the values for .MEASURE and/or .FFT statements using existing Xyce output files. This is useful for tuning .MEASURE and/or .FFT statements to better capture response metrics for a circuit when the underlying simulation runtime is long. To use this functionality, add the command line argument `-remeasure <file>`, where `<file>` is a Xyce-generated .prn, .csv or .csd output file.

There are several important limitations with `-remeasure`:

- The data required by the .MEASURE and/or .FFT statements must have been output in the simulation output file. When using `-remeasure`, Xyce does not recalculate the full solution, but uses the data supplied in the output file instead. Thus, everything a .MEASURE and/or .FFT statement needs to calculate its results must be in the output file. So, the nodal voltages (e.g., node A), lead currents (e.g, for device R1) and branch currents requested by the .MEASURE statements must have been used, at least once, on the .PRINT statement in the form of V(A), N(a) or I(R1). They can not only appear on the .PRINT line within an expression or a voltage-difference operator.
- Only voltage node values, lead currents and branch currents can be used in .MEASURE statements while using `-remeasure`. Power values will not be interpreted correctly during a re-measure operation. A work-around for that limitation is illustrated below.
- `-remeasure` only works with .tran or .dc analyses. However, it can be used with .STEP in both cases. It is not currently supported for .ac analyses.
- For .tran analyses, `-remeasure` works with .prn, .csv and .csd formatted output data. However, it might only work with .csv and .csd files generated by Xyce.
- For .dc analyses, `-remeasure` works with .prn and .csd formatted output data. However, it might only work with .csd files generated by Xyce.
- `-remeasure` will fail if the netlist has a .op statement that precedes the .tran or .dc statement. This can be fixed by either moving the .op statement or by temporarily commenting the .op statement out during `-remeasure`.

As an example in using `-remeasure`, consider a netlist called `myCircuit.cir` which had previously been run in Xyce and produced the output file `myCircuit.cir.prn`. One could run `-remeasure` with the following command:

```
Xyce -remeasure myCircuit.cir.prn myCircuit.cir
```

A work-around for re-measuring power values (e.g., for device R1) is to use this combination of `.PRINT` and `.MEASURE` lines in the netlist. As noted above, expressions will work with re-measure if all of the quantities used in the expression also appear outside of an expression on the `.PRINT` line.

```
R1 a b 1
.PRINT TRAN V(a) V(b) I(R1)
.MEASURE TRAN PR1B MAX {(V(a)-V(b))*I(R1)}
```

2.1.18.5. RISE, FALL and CROSS Qualifiers

The RISE, FALL and CROSS qualifiers are supported for more measures types, and in more ways, in Xyce than in HSPICE for TRAN measures. This section explains those differences and supplies some examples. One key difference is that Xyce supports two different “modes” for these qualifiers for TRAN measures.

The first mode is “level-crossing”, where the RISE, FALL and CROSS counts are incremented each time the measured signal (e.g. `V(a)`) crosses the user-specified level (termed `crossVal` here). This mode should work identically to HSPICE for the DERIV-WHEN, FIND-WHEN, WHEN and TRIG-TARG measures.

If we define `currentVal` and `lastVal` as the current and previous values of `V(a)`, and `riseCount`, `fallCount` and `crossCount` as the number of rises, falls and crosses that have occurred, then the pseudo-code for the “level-crossing” mode is:

```
if ( (currentVal-crossVal >= 0.0) AND (lastVal-crossVal < 0.0) )
{
    riseCount++;
    crossCount++;
}
else if( (currentVal-crossVal) <= 0.0) AND (lastVal-crossVal > 0.0) )
{
    fallCount++;
    crossCount++;
}
```

For DERIV-WHEN, FIND-WHEN, WHEN, measures, the cross value is set by the value (or second variable) in the WHEN clause. For TRIG-TARG measures, the cross values are set separately by the the values (or second variables) in the TRIG and TARG clauses.

The second mode is termed “absolute”. In this mode, Xyce attempts to auto-detect whether the measured waveform has started a new rise or fall. However, the `crossCount` is still evaluated against a fixed `crossVal` of 0. This mode may be useful for pulse waveforms with sharp rises and falls, where the waveform’s maximum (or minimum) level is not exactly known in advance. It may not work well with noisy waveforms.

If we define two Boolean variables `isRising` and `isFalling` then the pseudo-code for the “absolute” mode is:

```

if( (currentVal > lastVal) AND !isRising )
{
  isRising= true;
  isFalling = false;
  riseCount++;
}
else if( (currentVal < lastVal) AND !isFalling )
{
  isRising = false;
  isFalling = true;
  fallCount++;
}
if ( ( (currentVal >= 0.0) AND (lastVal < 0.0) ) OR
      ( (currentVal <= 0.0) AND (lastVal > 0.0) ) )
{
  crossCount++;
}

```

The following table shows which of these two modes are supported for which Xyce measure types.

Table 2-2. RISE, FALL and CROSS Support in .MEASURE.

Measure	Level-Crossing	Absolute
DERIV-WHEN	The crossVal is set by the value of the WHEN clause	No
FIND-WHEN and WHEN	The crossVal is set by the value of the WHEN clause	No
MAX	A fixed crossVal can be set with RFC_LEVEL	Default, if RFC_LEVEL is not set
MIN	A fixed crossVal can be set with RFC_LEVEL	Default, if RFC_LEVEL is not set
PP	A fixed crossVal can be set with RFC_LEVEL	Default, if RFC_LEVEL is not set
TRIG and TARG	The levels are set separately by the values in the TRIG and TARG clauses	Only if FRAC_MAX is used

As simple examples of these two modes for the MAX measure, consider the following netlist:

```

*examples of RFC modes
VPWL1 1 0 PWL(0 0 0.2 0.5 0.4 0 0.6 0.75 0.8 0 1.0 0.75 1.2 0.0)
R1 1 0 100
.TRAN 0 1.2s
.MEASURE TRAN MAX1 MAX V(1) RISE=1
.MEASURE TRAN MAX2 MAX V(1) RISE=1 RFC_LEVEL=0.6
.MEASURE TRAN MAX3 MAX V(1) FALL=1 RFC_LEVEL=0.5

```

```
.PRINT TRAN V(1) MAX1 MAX2 MAX3
.END
```

The descriptive output to standard output would then be:

```
MAX1 = 5.000000e-01 at time = 2.000000e-01
Measure Start Time= 0.000000e+00      Measure End Time= 1.200000e+00
Rise 1: Start Time= 1.000000e-10      End Time= 4.000000e-01

MAX2 = 7.500000e-01 at time = 6.000000e-01
Measure Start Time= 0.000000e+00      Measure End Time= 1.200000e+00
Rise 1: Start Time= 5.600000e-01      End Time= 9.500000e-01

MAX3 = 7.500000e-01 at time = 1.000000e+00
Measure Start Time= 0.000000e+00      Measure End Time= 1.200000e+00
Fall 1: Start Time= 6.700000e-01      End Time= 1.060000e+00
```

The MAX1 measure uses the “absolute” mode, so the first rise begins with the very first time-step. The maximum value in that first rise interval for measure MAX1 then occurs at time=0.2s. The MAX2 measure uses the “level-crossing” mode with a user-specified RFC_LEVEL of 0.6V. So, the first rise interval for the MAX2 measure begins at time=0.56s, and the maximum value in that first rise interval occurs at time=0.6s. The MAX3 measure illustrates an important point. A “fall” is not recorded for the MAX3 measure at t=0.2 seconds, but a “rise” (and “cross”) would be recorded, since the value of V(1) is exactly equal to the user-specified RFC_LEVEL. So, the first fall interval for measure MAX3 begins at time=0.67s, when V(1) first passes through the user-specified RFC_LEVEL of 0.5V.

2.1.18.6. Additional Examples

Pulse width measurements in Xyce can be done as follows, based on this netlist excerpt. This may be useful for ensemble runs, where the maximum value of a one-shot pulse is not known in advance. The first syntax uses three measure statements to measure the 50% pulse width, and works with noisy waveforms. The second syntax uses only one measure statement, but may not always work with noisy waveforms.

```
* pulse-width measurement example 1
.measure tran rise50FracMax trig v(1) frac_max=0.5 targ v(1) frac_max=1
.measure tran fall50FracMax trig v(1) frac_max=1 targ v(1) frac_max=0.5
.measure tran 50width EQN{rise50FracMax + fall50FracMax}

* pulse-width measurement example 2
.measure tran 50widthFracMax trig v(1) frac_max=0.50
+ targ v(1) frac_max=0.50 FALL=1
```

In some cases, the user may wish to print out both the measure value and measure time (or the value of the first variable on the .DC line) of a MAX or MIN measure to the .mt0 file. For a TRAN measure, this can be done for these two measures with the OUTPUT keyword as follows:

```

* printing maximum value and time of maximum value to .mt0 file
.TRAN 0 1
V1 1 0 PWL 0 0 0.5 1 1 0
R1 1 0 1
.MEASURE TRAN MAXVAL MAX V(1)
.MEASURE TRAN TIMEOFMAXVAL MAX V(1) OUTPUT=TIME

```

The output to the .mt0 file would be:

```

MAXVAL = 1.000000e+00
TIMEOFMAXVAL = 5.000000e-01

```

The descriptive output to standard output would be the same for both measures though. The measure value and measure time are not re-ordered in the descriptive output when OUTPUT=VALUE is used for the MAX or MIN measures.

```

MAXVAL = 1.000000e+00 at time = 5.000000e-01
Measure Start Time= 0.000000e+00      Measure End Time= 1.000000e+00

TIMEOFMAXVAL = 1.000000e+00 at time = 5.000000e-01
Measure Start Time= 0.000000e+00      Measure End Time= 1.000000e+00

```

For a DC measure, one would use OUTPUT=SV instead of OUTPUT=TIME. In that case, the “sweep value” (SV) is the value of the first variable on the .DC line. For an AC or NOISE measure, one would use OUTPUT=FREQ.

2.1.18.7. Suppressing Measure Output

If the Xyce output is post-processed with other programs, such as Dakota, it may be desirable to only print a subset of the measure values to the .mt# (or .ms# or .ma#) files, but to print all of the measure output to standard output. As an example, these .MEASURE statements:

```

.TRAN 0 2ms
.measure tran minSineOne min V(1) print=none
.measure tran minSinTwo min V(2) print=stdout
.measure tran minSinThree min V(3) print=all
.measure tran sinSinFive min V(4)

```

would produce the following measure output in the .mt0 file:

```

MINSINTHREE = -3.851422e-01
MINSINFOUR = -1.998548e+00

```

and the following measure output in standard output:

MINSINTWO = -1.188589e+00 at time = 7.400000e-04
 Measure Start Time= 0.000000e+00 Measure End Time= 2.000000e-03

MINSINTHREE = -3.851422e-01 at time = 2.400000e-04
 Measure Start Time= 0.000000e+00 Measure End Time= 2.000000e-03

MINSINFOUR = -1.998548e+00 at time = 7.500000e-04
 Measure Start Time= 0.000000e+00 Measure End Time= 2.000000e-03

.OPTIONS MEASURE MEASPRINT=<val> also provides the option to accomplish these same effects, but for all of the measure statements in the netlist. The interactions between these two features are as follows. If MEASPRINT=ALL is used, which is the default setting, then the PRINT qualifier on a given .MEASURE line will override that setting. However, MEASPRINT=NONE and MEASPRINT=STDOUT will take precedence over the PRINT qualifiers on individual .MEASURE lines. Finally, the MEASPRINT option will be ignored during remeasure, but the PRINT qualifiers on individual measure lines will be used.

.OPTIONS MEASURE MEASOUT=<val> provides another way to suppress the output of the .mt# (or .ms# or .ma#) files. See Section 2.1.25 for more details. If given, this option takes precedence over the MEASPRINT option setting. However, it is also ignored during remeasure.

2.1.18.8. ERROR Functions (ERR1 and ERR2)

This subsection defines the calculation functions for the ERR1 and ERR2 measure types. For the ERR1 measure, the measure value is calculated as follows, where M_i and C_i are the first and second variables on the measure line and N is the number of time, frequency or DC sweep values included in the measure calculation:

$$ERR1 = \sqrt{\frac{1}{N} \sum_{i=1}^N \left(\frac{M_i - C_i}{\max(MINVAL, |M_i|)} \right)^2} \quad (2.1)$$

For the ERR2 measure, the value is:

$$ERR2 = \frac{1}{N} \sum_{i=1}^N \left| \frac{M_i - C_i}{\max(MINVAL, |M_i|)} \right| \quad (2.2)$$

For both measures, if the absolute value of M_i is less than the YMIN value or greater than the YMAX value then the ERR1 or ERR2 calculation does not consider that point. The default for YMIN is 1.0-e15. The default for YMAX is 1.0e15.

2.1.18.9. ERROR Measure

The Xyce ERROR measure is not the functional equivalent of the ERR1 or ERR2 measures. It is intended to solve a different problem, namely the comparison of data in multiple simulation runs to an assumed “gold standard” read in from a file. It also uses different comparison functions than the ERR1 and ERR2 measures.. This subsection lists some important caveats with the use of the ERROR measure.

- The comparison file, specified with the FILE qualifier, can be .prn, .csv and .csd formatted output data. However, the ERROR measure might only work with .csv and .csd files generated by Xyce.

- The data in the comparison file is assumed to be “non-step data”, from one simulation iteration. The simulated data can use .STEP though and the ERROR measure values will be re-evaluated for each step.
- For TRAN (or AC or NOISE) measures, the values of the measured waveform are interpolated to the simulation times (or frequencies) in the comparison waveform. So, the norm calculation is inherently windowed to the time (or frequency) interval of the comparison waveform. For the best interpolation results for AC or NOISE measures, it is recommended that the frequency extent of the comparison waveform be greater than or equal to the frequency extent of the measured waveforms.
- For DC measures, interpolation is not used. So, the values of the simulated and comparison waveforms are compared at the values specified by the DEPVARCOL qualifier. Any value for the INDEPVARCOL qualifier specified on a DC measure line will be “silently ignored”.
- The time and frequency window constraints (TO, FROM and TD qualifiers) are not supported for the ERROR measure. So, as noted above, the effective window for the norm calculation is set by the extent of the comparison waveform.
- The values in the column in the comparison file specified with the INDEPVARCOL qualifier must be monotonically increasing for a TRAN, AC or NOISE measure. Otherwise, Xyce will not run the simulation.
- The ERROR measure currently supports the L1, L2 and INFNORM, with the default being the L2 norm. If anything other than L1, L2 or INFNORM is specified, Xyce will default to the L2 norm. The descriptive output for each ERROR measure, that is printed to standard output, will explicitly state which norm was used for each ERROR measure. (Note: The norm value is selected with the COMP_FUNCTION qualifier, and the allowed values are L1NORM, L2NORM and INFNORM.)

As a final note, the ERROR measure can enable the use of Xyce simulation output in optimization problems, like device calibration. However, for internal Sandia users, there may be better approaches that leverage the combined capabilities of Sandia’s Dakota and Xyce software packages.

2.1.18.10. Operator Support for AC Mode Measures

All of the operators supported on .PRINT AC lines are supported for AC measure mode. The linear parameter operators (e.g., SR(1, 1)) are only supported when a .LIN analysis is done, but their values can be used in .MEASURE AC statements in that case.

One caveat is that AC mode measures that use V(a) will actually measure VR(a). The same caveat applies to the use of S(1, 1). An AC mode measure would measure SR(1, 1) instead.

2.1.18.11. Operator Support for NOISE Mode Measures

All of the operators supported on .PRINT NOISE lines are supported for NOISE measure mode. One caveat is that NOISE mode measures that use V(a) will actually measure VR(a).

2.1.18.12. Behavior for Unsupported Modes and Types

The `.MEASURE` statement is supported for `.TRAN`, `.AC`, `.DC` and `.NOISE` analyses. It can be used with `.STEP` in all four cases. So, Xyce does not support HB measure mode. If that mode is included in the netlist then Xyce parsing will fail and emit error messages. Similarly, Xyce parsing will fail if the requested measure type is not supported for a given measure mode (e.g., `OFF_TIME` for a `AC`, `DC` or `NOISE` measure).

2.1.18.13. Compatibility with `.DATA`

The `.DATA` command can be used to specify table-based `.AC`, `.DC` or `.NOISE` sweeps for those three analysis types. For `AC` and `NOISE` measures, the “swept variable” then uses the frequency values in the table specified on the `.AC` or `.NOISE` line.

For `DC` measures, the swept variable uses the row index in the table specified on the `.DC` line. An example is as follows:

```
* example of .DATA with DC measures
```

```
V1 1 0 1
```

```
R1 1 2 1
```

```
R2 2 0 1
```

```
.data test
```

```
+ r1          r2
```

```
+ 1.0e+00    4.0e+00
```

```
+ 4.0e+00    6.0e+00
```

```
+ 6.0e+00    4.0e+00
```

```
.enddata
```

```
.DC data=test
```

```
.print DC V(1) V(2)
```

```
.OPTIONS MEASURE MEASDGT=1
```

```
.MEASURE DC MAXV2TO MAX V(2) TO=2
```

```
.MEASURE DC MAXV2FROM MAX V(2) FROM=2
```

```
.END
```

The measure results reported in stdout will be as follows where the respective maximum values occur for the R1 and R2 values given in the first and second rows of the test table:

```
MAXV2TO = 8.0e-01 at Table Row value = 1.0e+00
```

```
Measure Start Table Row Value= 1.0e+00 Measure End Table Row Value= 2.0e+00
```

```
MAXV2FROM = 6.0e-01 at Table Row value = 2.0e+00
```

```
Measure Start Table Row Value= 2.0e+00 Measure End Table Row Value= 3.0e+00
```

All valid measure types will return an answer when a data-based sweep is used on the `.AC`, `.DC` or `.NOISE` line. However, the results for `AVG`, `DERIV`, `FIND`, `INTEG`, `RMS` and `WHEN` measures may be “non-physical” if the frequency values in the data table are not monotonically increasing. In addition, for DC measures the effective step size between table rows is equal to one.

2.1.18.14. HSPICE Compatibility

There are known incompatibilities between the Xyce and HSPICE implementation of `.MEASURE`. They include the following:

- Since `.AC` and `.NOISE` are separate analysis types in Xyce, there are separate AC and NOISE measure modes.
- Several of the Xyce measure types (`DUTY`, `EQN`, `FREQ`, `FOUR`, `ON_TIME`, and `OFF_TIME`) and qualifiers (e.g., `FRAC_MAX`) are not found in HSPICE. Several HSPICE measure types are not supported in Xyce.
- The default, in both HSPICE and Xyce, for `DERIV-WHEN`, `FIND-WHEN`, `WHEN` and `TRIG-TARG` measures is to use `CROSS=0` if a `RISE`, `FALL` or `CROSS` value is not explicitly given in the `WHEN`, `TRIG` or `TARG` clause. However, the Xyce and HSPICE results may differ in those cases if the measured signal is either a constant value or meets the measure criteria at the first simulation step (e.g., `t=0`).
- The HSPICE qualifiers of `REVERSE` and `PREVIOUS` are not supported in Xyce.
- The HSPICE `.POWER` statement, which prints out a table with the `AVG`, `RMS`, `MIN` and `MAX` measures for each specified signal, is not supported in Xyce.
- Xyce generally supports more qualifiers (`FROM`, `TO`, `TD`, `RISE`, `FALL` and `CROSS`) for the measurement windows for a given measure-type. So, some legal Xyce syntaxes may not be legal in HSPICE.
- The Xyce `EQN` measure can calculate an expression based on other measure values. So, one of its usages is similar to the HSPICE `PARAM` measure. However, their syntaxes are different.
- A mismatch between the measure mode and the analysis mode (e.g., a DC measure in a netlist that uses a `.TRAN` analysis statement) will cause a Xyce netlist parsing error. That same mismatch might be silently ignored by HSPICE.
- How Xyce and HSPICE handle “steps” may be different. In Xyce, the “steps” in the measured data (e.g., the generation of new `.mt#` or `.ms#` or `.ma#` files) are triggered by the variable(s) on the `.STEP` line, but not by the variable(s) on the `.DC` line.
- Expressions on `.MEASURE` lines are supported in fewer contexts than in HSPICE. See the “Expression Support” subsection for more details.
- The settings for the `MEASFAIL` and `MEASOUT` options are only used if those options are explicitly given in the netlist. Otherwise, the Xyce defaults will be used.

The following HSPICE syntax (`VAL=0.9`) is supported in Xyce for `TRIG` and `TARG` measures. However, the preferred Xyce syntax would use `targ v(1)=0.9` instead.

```
.measure tran riseSine trig v(1) AT=0.0001 targ v(1) VAL=0.9 RISE=1
```

The remainder of this subsection discusses alternate syntaxes for Xyce measure lines that are supported for improved HSPICE compatibility. The definitions of the measure syntaxes given at the beginning of this .MEASURE section give the preferred Xyce syntaxes. However, PARAM (and the equivalent EQN) measure lines are allowed with, or without, the equal sign after the PARAM keyword. So, these two Xyce measure statements are equivalent:

```
.measure tran noEqualSgn PARAM {v(1)+1.0}  
.measure tran equalSgn PARAM={v(1)+1.0}
```

There are multiple expression syntaxes that are allowed in various contexts on HSPICE measure lines. So, all of these example syntaxes are allowed in expression contexts on Xyce measure lines. (Note: Only the first single-quote-delimited expression format is supported in all Xyce expression contexts, in addition to the Xyce curly-braces format.)

```
.measure tran curlyBraces MAX {V(1)+1}  
.measure tran singleQuote MAX 'V(1)+1'  
.measure tran parenSingleQuote MAX ('V(1)+1')  
.measure tran parSyntax MAX PAR('V(1)+1')
```

Undelimited expressions are allowed in some contexts in HSPICE. However, the syntax for the notLegalInXyce measure shown below is not allowed in Xyce, since it uses an undelimited expression.

```
.measure tran PLUS PP PAR('V(1)+V(2)')  
.measure tran notLegalInXyce PARAM PLUS+2.0 ; not legal
```

2.1.18.15. Legacy Trig-Targ Mode (LTTM)

For the Xyce 7.5 release, the code for the TRIG-TARG measure was extensively re-written to provide better HSPICE (and ngspice) compatibility. However, mostly for backwards compatibility for internal Sandia users, the previous behavior can be recovered by using .OPTION MEASURE USE_LTTM=1 in the netlist. It is anticipated that this feature will be removed in a future release. However, support for the FRAC_MAX qualifier, which is not in either HSPICE or ngspice, will likely be continued.

The allowed syntaxes for this mode are shown below. Note that this mode lacks several features. In particular:

- The AT qualifier is only allowed in the TRIG clause.
- The FROM, TO and TD qualifiers apply to both the TRIG and TARG clauses.
- Expression support, especially in the TARG clause, was less available.

General Form

```
.MEASURE TRAN <result name> TRIG <variable>=<variable2>|<value>  
+ [RISE=r1|LAST] [FALL=f1|LAST] [CROSS=c1|LAST]  
+ TARG <variable3>=<variable4>|<value>  
+ [RISE=r2|LAST] [FALL=f2|LAST] [CROSS=c2|LAST]  
+ [FROM=<value>] [TO=<value>] [TD=<value>]  
+ [DEFAULT_VAL=<value>] [PRECISION=<value>] [PRINT=<value>]
```

```
.MEASURE TRAN <result name> TRIG AT=<value>  
+ TARG <variable2>=<variable3>|<value>  
+ [RISE=r2|LAST] [FALL=f2|LAST] [CROSS=c2|LAST]  
+ [FROM=<value>] [TO=<value>] [TD=<value>]  
+ [DEFAULT_VAL=<value>] [PRECISION=<value>] [PRINT=<value>]
```

2.1.19. **.MEASURE (Continuous results)**

“Continuous” measure results are supported for DERIV-AT, DERIV-WHEN, FIND-AT, FIND-WHEN, WHEN and TRIG-TARG measures for .TRAN, .DC, .AC and .NOISE analyses. They are identical to the “non-continuous” versions, except that they can return more than one measured value in some cases.

General Form .MEASURE <AC_CONT|DC_CONT|NOISE_CONT|TRAN_CONT> <result name>
+ DERIV <variable> AT=<value>
+ [MINVAL=<value>] [DEFAULT_VAL=<value>]
+ [PRECISION=<value>] [PRINT=<value>]

```
.MEASURE TRAN_CONT <result name>  
+ DERIV <variable> WHEN <variable>=<variable2>|<value>  
+ [MINVAL=<value>] [FROM=<value>] [TO=<value>] [TD=<value>]  
+ [RISE=r|LAST] [FALL=f|LAST] [CROSS=c|LAST]  
+ [DEFAULT_VAL=<value>] [PRECISION=<value>] [PRINT=<value>]
```

```
.MEASURE <AC_CONT|DC_CONT|NOISE_CONT> <result name>  
+ DERIV <variable> WHEN <variable>=<variable2>|<value>  
+ [MINVAL=<value>] [FROM=<value>] [TO=<value>]  
+ [RISE=r|LAST] [FALL=f|LAST] [CROSS=c|LAST]  
+ [DEFAULT_VAL=<value>] [PRECISION=<value>] [PRINT=<value>]
```

```
.MEASURE <AC_CONT|DC_CONT|NOISE_CONT|TRAN_CONT> <result name>  
+ FIND <variable> AT=<value>  
+ [MINVAL=<value>] [DEFAULT_VAL=<value>]  
+ [PRECISION=<value>] [PRINT=<value>]
```

```
.MEASURE TRAN_CONT <result name>  
+ FIND <variable> WHEN <variable>=<variable2>|<value>  
+ [FROM=<value>] [TO=<value>] [TD=<value>]  
+ [RISE=r|LAST] [FALL=f|LAST] [CROSS=c|LAST]  
+ [MINVAL=<value>] [DEFAULT_VAL=<value>]  
+ [PRECISION=<value>] [PRINT=<value>]
```

```
.MEASURE <AC_CONT|DC_CONT|NOISE_CONT> <result name>  
+ FIND <variable> WHEN <variable>=<variable2>|<value>  
+ [FROM=<value>] [TO=<value>]  
+ [RISE=r|LAST] [FALL=f|LAST] [CROSS=c|LAST]  
+ [MINVAL=<value>] [DEFAULT_VAL=<value>]  
+ [PRECISION=<value>] [PRINT=<value>]
```

```
.MEASURE TRAN_CONT <result name>  
+ WHEN <variable>=<variable2>|<value>  
+ [FROM=<value>] [TO=<value>] [TD=<value>]  
+ [RISE=r|LAST] [FALL=f|LAST] [CROSS=c|LAST]  
+ [MINVAL=<value>] [DEFAULT_VAL=<value>]  
+ [PRECISION=<value>] [PRINT=<value>]
```

```
.MEASURE <AC_CONT|DC_CONT|NOISE_CONT> <result name>
+ WHEN <variable>=<variable2>|<value>
+ [FROM=<value>] [TO=<value>]
+ [RISE=r|LAST] [FALL=f|LAST] [CROSS=c|LAST]
+ [MINVAL=<value>] [DEFAULT_VAL=<value>]
+ [PRECISION=<value>] [PRINT=<value>]

.MEASURE <AC_CONT|DC_CONT|NOISE_CONT|TRAN_CONT> <result name>
+ TRIG <variable1>=<variable2>|<value>
+ [TD=<val>] [RISE=r] [FALL=f] [CROSS=c]
+ TARG <variable3>=<variable4>|<value>
+ [TD=<val>] [RISE=r] [FALL=f] [CROSS=c]
+ [MINVAL=<value>] [DEFAULT_VAL=<value>]
+ [PRECISION=<value>] [PRINT=<value>]

.MEASURE <AC_CONT|DC_CONT|NOISE_CONT|TRAN_CONT> <result name>
+ TRIG AT=<value> TARG AT=<value>
+ [MINVAL=<value>] [DEFAULT_VAL=<value>]
+ [PRECISION=<value>] [PRINT=<value>]
```

Examples

```
.MEASURE TRAN_CONT DERIV1at5 DERIV V(1) AT=5
.MEASURE DC_CONT deriv2 DERIV WHEN V(2)=0.75
.MEASURE AC_CONT find1at5 FIND V(1) AT=5
.MEASURE NOISE_CONT find1 FIND V(1) WHEN V(2)=1 RISE=2
.MEASURE TRAN_CONT whenv1 WHEN V(1)=5
.MEASURE TRAN_CONT TrigTargAT TRIG AT=2ms TARG AT=8ms
.MEASURE TRAN_CONT TrigTargAT1 TRIG V(1)=0.2 CROSS=1
+ TARG AT=8ms
.MEASURE TRAN_CONT TrigTargAT2 TRIG AT=2ms
+ TARG V(1)=0.2 CROSS=1
.MEASURE TRAN_CONT TrigTarg TRIG V(1)=0.2 CROSS=1
+ TARG V(1)=0.3 CROSS=1 TD=8ms
```

Arguments and Options

result name

Measured results are reported to the log file and (possibly) multiple output files. Section 2.1.19.1 below gives more information on the output files produced by continuous mode measures.

The <result name> must be a legal Xyce character string. If multiple measures are defined with the same <result name> then Xyce uses the last such definition, and issues warning messages about (and discards) any previous measure definitions with the same <result name>.

measure type

DERIV, FIND, WHEN, TRIG, TARG

The third argument specifies the type of measurement or calculation to be done.

By default, the measurement is performed over the entire simulation. The calculations can be limited to a specific measurement window by using the qualifiers FROM, TO, TD, RISE, FALL, CROSS and MINVAL, which are explained below and in section 2.1.18..

The supported “continuous” measure types and their definitions are:

DERIV Computes the derivative of <variable> at a user-specified time (by using the AT qualifier) or when a user-specified condition occurs (by using the WHEN qualifier). If the WHEN qualifier is used then the measurement window can be limited with the qualifiers FROM, TO, RISE, FALL and CROSS for all measure modes. In addition, the TD qualifier is supported for TRAN_CONT measures. The MINVAL qualifier is used as a comparison tolerance for both AT and WHEN. For HSPICE compatibility, DERIVATIVE is an allowed synonym for DERIV.

FIND-AT Returns the value of <variable> at the time when the AT clause is satisfied. The AT clause is described in more detail later in this list.

FIND-WHEN Returns the value of <variable> at the time when the WHEN clause is satisfied. The WHEN clause is described in more detail later in this list.

WHEN Returns the time (or frequency or DC sweep value) when <variable> reaches <variable₂> or the constant value, value. The measurement window can be limited with the qualifiers FROM, TO, RISE, FALL and CROSS for all measure modes. In addition, the TD qualifier is supported for TRAN_CONT measures. The qualifier MINVAL acts as a tolerance for the comparison. For example when <variable₂> is specified, the comparison used is when <variable> = <variable₂> ± MINVAL or when a constant, value is given: <variable> = value ± MINVAL. If the conditions specified for finding a given value were not found during the simulation then the measure will return the default value of -1. The user may change this default value with the DEFAULT_VAL qualifier. Note: The use of FIND and WHEN in one measure statement is also supported.

TRIG

TARG Measures the time between a trigger event and a target event. The trigger is specified with TRIG <variable₁>=<variable₂> or TRIG <variable₁>=<value> or TRIG AT=<value>. The target is specified as TARG <variable₃>=<variable₄> or TARG <variable₃>=<value> or TARG AT=<value>. The measurement window can be limited with the qualifiers TD, RISE, FALL and CROSS for all measure modes. The qualifier MINVAL acts as a tolerance for the comparison. For example when <variable₂> is specified, the comparison used is when <variable₁> = <variable₂> ± MINVAL or when a constant, value is given: <variable₁> = value ± MINVAL. If the conditions specified for finding a given value were not found during

the simulation then the measure will return the default value of -1. The user may change this default value with the DEFAULT_VAL qualifier.

variable
variable_n
value

These quantities represents the test for the stated measurement. <variable> is a simulation quantity, such as a voltage or current. One can compare it to another simulation variable or a fixed quantity. Additionally, the <variable> may be a Xyce expression delimited by { } brackets. As noted above, an example is V(2)=0.75

Additional information on the TO, FROM, TD, RISE, FALL, CROSS, MINVAL, DEFAUAL_VAL, PRECISION and PRINT qualifiers is given in section 2.1.18.

2.1.19.1. Measure Output

As discussed in section 2.1.18.1, measured results for AC, DC, NOISE and TRAN mode measures are reported to the log file. Additionally, for TRAN measures, the results are stored in files called circuitFileName.mt#, where the suffixed number (#) starts at 0 and increases for multiple iterations (.STEP iterations) of a given simulation. For DC measures, the results are stored in the files circuitFileName.ms#, while AC and NOISE measures use the files circuitFileName.ma#.

For AC_CONT, DC_CONT, NOISE_CONT and TRAN_CONT mode measures, the output for successful and failed measures is sent to the standard output (and log files), as described in section 2.1.18.1. There are two options for the output files though. The default is for each continuous mode measure to generate its own output file where, for example for a non-step transient analysis, the file name would be circuitFileName_resultname.mt0 where the result (measure) name is always output in lower-case. This default matches HSPICE. The second option uses .OPTIONS MEASURE USE_CONT_FILES=0. In that case, the results for all of the continuous mode measures are sent to the circuitFileName.mt# file.

An example is as follows.

```
VPWL1 1 0 pw1(0 0 2.5m 1 5m 0 7.5m 1 10m 0)
R1 1 0 1

.TRAN 0 10ms
.PRINT TRAN V(1)

.MEASURE TRAN MAXV1 MAX V(1)
.MEASURE TRAN_CONT FindV1 WHEN V(1)=0.5
.MEASURE TRAN_CONT FindV1AT FIND V(1) AT=0.6ms

.END
```

The result for measure MAXV1 is sent to <netlistName>.mt0. The results for measures FindV1 and FindV1AT are then sent to individual files, named <netlistName>_findv1.mt0 and <netlistName>_findv1at.mt0. Note that the measure names have been lower-cased in the output file names. The contents of those files are then as follows.

```
FINDV1 = 1.250000e-03
FINDV1 = 3.750000e-03
FINDV1 = 6.250000e-03
FINDV1 = 8.750000e-03
```

and:

```
FINDV1AT = 2.400000e-01
```

Note that FIND-AT measures will still only return one measure value, even for TRAN_CONT measure mode. However, in this simple example, the specified FIND-WHEN measure returns all four times where V(1) equals 0.5. The next subsection will describe how the RISE, FALL and CROSS qualifiers can be used to return only a subset of those four crossings.

2.1.19.2. RISE, FALL and CROSS Qualifiers

Xyce supports non-negative values for the RISE, FALL and CROSS qualifiers for all continuous measure types. It supports negative values for the RISE, FALL and CROSS qualifiers for the DERIV-WHEN, FIND-WHEN and WHEN measure types. However, their interpretation is slightly different for TRAN and TRAN_CONT measure modes, as illustrated by the following netlist for the TRAN_CONT measure mode and WHEN measure. The rules are then the same for the other continuous measures modes and the RISE and FALL qualifiers.

```
VPWL1 1 0 pw1(0 0 2.5m 1 5m 0 7.5m 1 10m 0)
R1 1 0 1

.TRAN 0 10ms
.PRINT TRAN V(1)

.MEASURE TRAN FindV1_CROSS3 WHEN V(1)=0.5 CROSS=3
.MEASURE TRAN_CONT FindV1_CONT_CROSS3 WHEN V(1)=0.5 CROSS=3

.MEASURE TRAN FindV1_CROSS_NEG3 WHEN V(1)=0.5 CROSS=-3
.MEASURE TRAN_CONT FindV1_CONT_CROSS_NEG3 WHEN V(1)=0.5 CROSS=-3

.END
```

The <netlistName>.mt0 file will contain the results for both TRAN mode measures. The result for the FindV1_CROSS3 is the time of the third crossing. The result for the FindV1_CROSS_NEG3 is the time of the second crossing, which is also the “third to last” (or negative third) crossing in this case.

```
FINDV1_CROSS3 = 6.250000e-03
FINDV1_CROSS_NEG3 = 3.750000e-03
```

The <netlistName>_findv1_cont_cross3.mt0 output file will have two values. For non-negative values of CROSS, a TRAN_CONT measure will return all crossings, starting with the specified value. This is the third and fourth crossings in this case.

FINDV1_CONT_CROSS3 = 6.250000e-03
FINDV1_CONT_CROSS3 = 8.750000e-03

For negative values of CROSS, a TRAN_CONT measure will only return one value. That is the third-to-last crossing in this case. So, the <netlistName>_findv1_cont_cross3_neg3.mt0 file only has one value in it. As a final note, a CROSS value of either 5 or -5 would produce failed measures in this example.

FINDV1_CONT_CROSS_NEG3 = 3.750000e-03

2.1.19.3. AT and TD Qualifiers for TRIG-TARG

The following rules apply to the AT and TD qualifiers for TRIG-TARG measures:

- Separate AT values can be given for the TRIG and TARG clauses.
- Separate TD values can be given for the TRIG and TARG clauses.
- The AT value takes precedence over the TD qualifier if both are given in a TRIG or TARG clause.
- If the TD value is only given for the TRIG clause then that value will be used for both the TRIG and TARG clauses.
- An AT value that is outside of the simulation window, or a TD value that is greater than the end simulation time or the largest AC, DC or NOISE sweep value, will produce a failed measure.
- A TD value that is less than 0, or the smallest AC, DC or NOISE sweep value, is essentially ignored.

2.1.19.4. HSPICE Compatibility

There are known incompatibilities between the Xyce and HSPICE implementation of continuous measures. They include the following:

- Xyce will not return a trig or targ value that is outside of the simulation bounds. In some case, HSPICE will return a trig or targ value that is earlier than the start of the simulation window.
- Xyce does not support negative values for the RISE, FALL or CROSS qualifiers for the continuous version of the TRIG-TARG measure.

2.1.20. **.MEASURE FFT (Measure output for .FFT)**

The `.MEASURE FFT` statement allows calculation or reporting of simulation metrics, from data associated with `.FFT` analyses, to an external file as well as to the standard output and/or a log file. So, it is only supported for `.TRAN`, analyses. It can be used with `.STEP`. For HSPICE compatibility, `.MEAS` is an allowed synonym for `.MEASURE`.

The syntaxes for the `.MEASURE FFT` statements are shown below.

General Form

```
.MEASURE FFT <result name> ENOB <variable> [BINSIZ=<value>]
+ [DEFAULT_VAL=<value>] [PRECISION=<value>] [PRINT=<value>]

.MEASURE FFT <result name> EQN <variable>
+ [DEFAULT_VAL=<value>] [PRECISION=<value>] [PRINT=<value>]

.MEASURE FFT <result name> FIND <variable> AT=<value>
+ [PRECISION=<value>] [PRINT=<value>]

.MEASURE FFT <result name> SFDR <variable>
+ [MINFREQ=<value>] [MAXFREQ=<value>] [BINSIZ=<value>]
+ [DEFAULT_VAL=<value>] [PRECISION=<value>] [PRINT=<value>]

.MEASURE FFT <result name> SNDR <variable> [BINSIZ=<value>]
+ [DEFAULT_VAL=<value>] [PRECISION=<value>] [PRINT=<value>]

.MEASURE FFT <result name> SNR <variable> [MAXFREQ=<value>]
+ [DEFAULT_VAL=<value>] [PRECISION=<value>] [PRINT=<value>]

.MEASURE FFT <result name> THD <variable>
+ [NBHARM=<value>] [MAXFREQ=<value>]
+ [DEFAULT_VAL=<value>] [PRECISION=<value>] [PRINT=<value>]
```

Examples

```
.FFT V(1) NP=16
.MEASURE FFT ENOBVAL ENOB V(1)
.MEASURE FFT EQNVAL EQN VR1AT2
.MEASURE FFT VR1AT2 VR(1) AT=2
.MEASURE FFT SFDRVAL SFDR V(1)
.MEASURE FFT SNDRVAL SNDR V(1)
.MEASURE FFT SNRVAL SNR V(1)
.MEASURE FFT THDVAL THD V(1)
```

Arguments and Options

result name

Measured results are reported to the output and log file. Additionally, the results are stored in files called `circuitFileName.mt#`, where the suffixed number (#) starts at 0 and increases for multiple iterations (`.STEP` iterations)

of a given simulation. Each line of this file will contain the measurement name, <result name>, followed by its value for that run. The <result name> must be a legal Xyce character string.

If multiple measures are defined with the same <result name> then Xyce uses the last such definition, and issues warning messages about (and discards) any previous measure definitions with the same <result name>.

measure type

ENOB, EQN, FIND, SFDR, SNDR, SNR, THD

The third argument specifies the type of measurement or calculation to be done. By default, the measurement is performed over the time window defined by the START and STOP parameters on the associated .FFT line. So, the FROM, TO and TD qualifiers have no effect on FFT-based measures.

The supported measure types are:

ENOB Calculates the “Effective Number of Bits”, where that metric is defined in Section 2.1.8.3 which covers the .FFT command.

EQN Calculates the value of <variable> during the simulation. That variable can use the results of other measure statements. PARAM is an allowed synonym for EQN as a measure type. For FFT measure mode, an EQN measure will be reported as “failed” until the associated FFT has been calculated.

FIND Returns the requested FFT coefficient at the requested frequency. Examples of the mapping of Xyce operators (e.g., VM and IM) to FFT coefficients is given in the “Additional Examples” subsection below. FIND measures can be also used in conjunction with EQN measures to generate fairly arbitrary FFT-based measures. The FIND measure for FFT measure mode does not support expressions, or the P and W operators. It also does not support multi-terminal lead current operators, such as ICC).

SFDR Calculates the “Spurious Free Dynamic Range”, where that metric is defined in Section 2.1.8.3.

SNDR Calculates the “Signal to Noise-plus-Distortion Ratio”, where that metric is defined in Section 2.1.8.3.

SNR Calculates the “Signal to Noise Ratio”, where that metric is defined in Section 2.1.8.3.

THD Calculates the “Total Harmonic Distortion”, where that metric is defined further below and also in in Section 2.1.8.3.

variable

The <variable> is a simulation quantity, such as a voltage or current. Additionally, the <variable> may be a Xyce expression delimited by { } brackets. The only constraint is that the variable on the .MEASURE FFT line must be an exact match for the ov on at least one .FFT line in the netlist. If there are multiple .FFT lines in the netlist with the same ov then the corresponding .MEASURE FFT statements will use the first such one.

AT=value

A frequency *at which* the measurement calculation will occur. This is used by the FIND measure only. The entered AT value will be rounded to the nearest harmonic frequency, as defined by the **FREQ**, **START** and **STOP** parameters on the associated **.FFT** line. An AT value that rounds to a harmonic frequency of less than zero, or to more than $NP/2$, will produce a failed measure in Xyce, where NP is the number of points specified on the associated **.FFT** line.. The behavior of these "failed" cases may differ from commercial simulators.

BINSIZ=value

This parameter is implemented in Xyce for the **ENOB**, **SFDR** and **SNDR** measure types. It can be used to account for any "broadening" of the spectral energy in the first harmonic of the signal, as discussed below. BINSIZ has a default value of 0.

DEFAULT_VAL=value

If the conditions specified for finding a given value are not found during the simulation then the measure will return the default value of -1 in the **circuitFileName.mt#** file. The measure value in the standard output or log file will be **FAILED**. The default return value for the **circuitFileName.mt#** file is settable by the user for each measure by adding the qualifier **DEFAULT_VAL=<retval>** on that measure line. If either **.OPTIONS MEASURE MEASFAIL=<val>** or **.OPTIONS MEASURE DEFAULT_VAL=<val>** are given in the netlist then those values override the **DEFAULT_VAL** parameters given on individual **.MEASURE FFT** lines. See Section 2.1.25 for more details.

MAXFREQ=value

The maximum frequency over which to perform a **SFDR**, **SNR** or **THD** measure. The entered **MAXFREQ** value will be rounded to the nearest harmonic frequency, as defined by the **FREQ**, **START** and **STOP** parameters on the associated **.FFT** line. The default value is $NP/2$, where NP is the number of points specified on the associated **.FFT** line.

MINFREQ=value

The minimum frequency over which to perform a **SFDR** or **THD** measure. The entered **MINFREQ** value will be rounded to the nearest harmonic frequency, as defined by the **FREQ**, **START** and **STOP** parameters on the associated **.FFT** line. The default value is 1.

NBHARM=value

The maximum (integer) number of harmonics over which to perform a **THD** measure. The default value is $NP/2$. The **NBHARM** qualifier has precedence over the **MAXFREQ** qualifier if both are given on a **.MEASURE** line.

PRECISION=value

The default precision for **.MEASURE** output is 6 digits after the decimal point. This argument provides a user configurable precision for a given **.MEASURE** statement that applies to both the **.mt#** file and standard output. If **.OPTIONS MEASURE MEASDGT=<val>** is given in the netlist then that value overrides the **PRECISION** parameters given on individual **.MEASURE** lines.

PRINT=value

This parameter controls where the .MEASURE output appears. The default is ALL, which produces measure output in both the .mt# and the standard output. A value of STDOUT only produces measure output to standard output, while a value of NONE suppresses the measure output to both the .mt# file and standard output.

2.1.20.1. Measure Definitions

The ENOB, SNDR, SNR and SFDR measure types use the same definitions as the metrics produced by .FFT lines. Section 2.1.8.3 provides more details on those definitions. (Note: The MAXFREQ and MINFREQ qualifiers from the .MEASURE FFT lines are mapped into the FMAX and FMIN parameters used in those equations.) There are two exceptions.

The first exception is the THD measure. If the optional NBHARM qualifier is not used then the definition given in Section 2.1.8.3 is used. If the NBHARM qualifier is used then it takes precedence over the MAXFREQ qualifier. The THD measure definition is then as follow. Let f_0 be the integer index of the “first harmonic” (f_0), as defined in Section 2.1.8.3, from the associated .FFT line. Then the effective value of the upper frequency limit (f_2) in the THD calculation is $NBHARM \cdot f_0$, with the caveat that all of the harmonics will be used if $NBHARM < 0$ or $NBHARM > NP/2$.

The second exception is the BINSIZ qualifier for the ENOB, SFDR and SNDR measures. For a non-zero value of BINSIZ, the “signal power” is considered to reside in the harmonic indexes between $(f_0 \pm BINSIZ)$, where the DC value is still excluded from the measure calculations. (Note: This definition for BINSIZ may differ from HSPICE.)

2.1.20.2. Re-Measure

Xyce can re-calculate (or re-measure) the values for .MEASURE FFT statements using existing Xyce output files. Section 2.1.18.4 discusses this topic in more detail for both .MEASURE and .FFT statements.

2.1.20.3. Additional Examples

This section provides a simple example how to use the FIND measure, along with the V(), VR(), VI(), VM(), VP() and VDB() operators, to obtain the real and imaginary parts of the FFT coefficients, along with the magnitude and phase of those coefficients, at a specified frequency. Those coefficient values are unnormalized.

* Example of obtaining FFT coefficients

```
.TRAN 0 1
.PRINT TRAN V(1)
.OPTIONS FFT FFT_ACCURATE=1 FFTOUT=1
V1 1 0 1
R1 1 0 1
.FFT V(1) NP=8 WINDOW=HANN
```

* Unnormalized one-sided FFT coefficients for V(1) at F=1.0

```
* Magnitude
.MEASURE FFT V1AT1 FIND V(1) AT=1.0
* Real part
.MEASURE FFT VR1AT1 FIND VR(1) AT=1.0
* Imaginary part
.MEASURE FFT VI1AT1 FIND VI(1) AT=1.0
* Magnitude
.MEASURE FFT VM1AT1 FIND VM(1) AT=1.0
* Phase
.MEASURE FFT VP1AT1 FIND VP(1) AT=1.0
* Magnitude in dB
.MEASURE FFT VDB1AT1 FIND VDB(1) AT=1.0

.END
```

The .MEASURE output is then:

```
FINDV1AT1 = 5.200051e-01
FINDVR1AT1 = -4.804221e-01
FINDVI1AT1 = -1.989973e-01
FINDVM1AT1 = 5.200051e-01
FINDVP1AT1 = -1.575000e+02
FINDVDB1AT1 = -5.679847e+00
```

2.1.21. **.MODEL (Model Definition)**

The `.MODEL` command provides a set of device parameters to be referenced by device instances in the circuit.

General Form `.MODEL <model name> <model type> (<name>=<value>)*`

Examples

```
.MODEL RMOD R (RSH=1)
.MODEL MOD1 NPN BF=50 VAF=50 IS=1.E-12 RB=100 CJC=.5PF TF=.6NS
.MODEL NFET NMOS(LEVEL=1 KP=0.5M VTO=2V)
```

Arguments and Options

`model name`

The model name used to reference the model.

`model type`

The model type used to define the model. This determines if the model is (for example) a resistor, or a MOSFET, or a diode, etc. For transistors, there will usually be more than one type possible, such as NPN and PNP for BJTs, and NMOS and PMOS for MOSFETs.

`name`

`value`

The name of a parameter and its value. Most models will have a list of parameters available for specification. Those which are not set will receive default values. Most will be floating point numbers, but some can be integers and some can be strings, depending on the definition of the model.

Comments

The scoping rules for models are:

- If a `.MODEL` statement is included in the main circuit netlist, then it is accessible from the main circuit and all subcircuits.
- `.MODEL` statements defined within a subcircuit are scoped to that subcircuit definition. So, their models are only accessible within that subcircuit definition, as well as within “nested subcircuits” also defined within that subcircuit definition.

Additional illustrative examples of scoping are given in the “Working with Subcircuits and Models” section of the Xyce Users’ Guide [1].

A model name can be the same as a device name in Xyce. However, that usage will generate a warning message during netlist parsing. The reason is that it can lead to ambiguous `.PRINT` lines when a model parameter and instance parameter, for a given device, have the same name but a different meaning. For example, `R1` could be used as both a resistor device-name, and as a resistor model-name. However, `.PRINT TRAN R1:R` would then be ambiguous. In addition, the use of duplicate model and device names is not recommended if those names will be used within a Xyce expression since that can result in an ambiguous expression.

2.1.21.1. LEVEL Parameter

A common parameter is the **LEVEL** parameter, which is set to an integer value. This parameter will define exactly which model of the given type is to be used. For example, there are many different available MOSFET models. All of them will be specified using the same possible names and types. The way to differentiate (for example) between the BSIM3 model and the PSP model is by setting the appropriate **LEVEL**.

2.1.21.2. Model Binning

Model binning is supported for MOSFET models. For model binning, the netlist contains a set of similar **.MODEL** cards which correspond to different sizing information (length and width). They are similar in that they are for the same model (and same **LEVEL** number), and have the same prefix. They are different in that they have different **lmin**, **lmax**, **wmin**, **wmax** parameters, and the name suffix will be the bin number. For a MOSFET device instance, Xyce will automatically select the appropriate binned model, based on the **L** and **W** parameters of that instance. It will only search the models with matching name prefixes, and can only work if all the binned models have specified all the **lmin**, **lmax**, **wmin**, **wmax** parameters.

Model binning is enabled by default. To disable it, specify `.options parser model_binning=false`.

```
* Model binning example adapted from the BSIM4 tests
m1 2 1 0 b nch L=0.11u W=10.1u NF=5 rgeomod=1 geomod=0
vgs 1 0 1.2
vds 2 0 1.2
Vb b 0 0.0

.dc vds 0.0 1.21 0.02 vgs 0.2 1.21 0.2

.print dc v(2) v(1) i(vds)

* model binning
.model nch.1 nmos(level=14
+ lmin=0.1u lmax=20u
+ wmin=0.1u wmax=10u)
.model nch.2 nmos(level=14
+ lmin=0.1u lmax=20u
+ wmin=10u wmax=100u)

.end
```

Figure 2-1. Model Binning Example

2.1.21.3. Length Scaling

It can be convenient to specify the lengths and widths for MOSFET instances in scaled units. To enable this, the netlist should include `.options parser scale` or `.option scale`. This feature is only supported in

MOSFET compact models. An example usage is given in figure 2-2. In this example, the scaled length and width for transistor mn1 is $l=5.0e-6$ and $w=175e-6$.

```
mos level 1 model cmos inverter using scale]
.tran 20ns 6us
.print tran v(vout) v(in) v(1)
vdddev vdd 0 5v
rin in 1 1k
vin1 1 0 5v pulse (5v 0v 1.5us 5ns 5ns 1.5us 3us)
r1 vout 0 10k
c2 vout 0 0.1p
mn1 vout in 0 0 cd4012_nmos l=5 w=175
mp1 vout in vdd vdd cd4012_pmos l=5 w=270

.options parser scale=1.0e-6

* also valid:
*.option scale=1.0e-6

.model cd4012_pmos pmos (level=1 uo=310 vto=-1.6 tox=6e-08)
.model cd4012_nmos nmos (level=1 uo=190 vto=1.679 tox=6e-08)
.end
```

Figure 2-2. Scale Example

2.1.22. **.NODESET (Approximate Initial Condition, Bias point)**

The `.NODESET` command sets initial conditions for operating point calculations. It is similar to `.IC` (Section 2.1.14), except it is applied as an initial guess, rather than as a firmly enforced condition. Like `.IC`, `.NODESET` initial conditions can be specified for some or all of the circuit nodes.

Consult the Xyce Users' Guide [1] for more guidance.

General Form `.NODESET < V(<node>)=<value>`
 `.NODESET <node> <value>`

Examples `.NODESET V(2)=3.1`
 `.NODESET 2 3.1`

Comments The Xyce `.NODESET` command uses a different strategy than either SPICE or HSPICE. When `.NODESET` is specified, Xyce does two solves for the DC operating point. One with the `.NODESET` values held as initial conditions (i.e., the same as if it was an `.IC` solve). The second solve is then done without any conditions imposed, but with the first solution as an initial guess.

The `.NODESET` capability can only set voltage values, not current values.

The `.NODESET` capability can not be used, within subcircuits, to set voltage values on global nodes.

2.1.23. **.NOISE (Noise Analysis)**

Calculates the the small signal noise response of a circuit over a range of frequencies. The .NOISE command can specify a linear sweep, decade logarithmic sweep, octave logarithmic sweep, or a data table of multivariate values.

General Form .NOISE V(OUTPUT <, REF>) SRC <sweep type> <points value>
 + <start frequency value> <end frequency value>

Examples .NOISE V(5) VIN LIN 101 100Hz 200Hz
 .NOISE V(5,3) V1 OCT 10 1kHz 16kHz
 .NOISE V(4) V2 DEC 20 1MEG 100MEG
 .NOISE V(4) V2 DATA=<table name>

Arguments and Options

V(OUTPUT <, REF>)

The node at which the total output noise is desired. If REF is specified, then the noise voltage V(OUTPUT) - V(REF) is calculated. By default, REF is assumed to be ground.

SRC The name of an independent source to which input noise is referred.

sweep type

Must be LIN, OCT, or DEC, as described below.

LIN Linear sweep

The sweep variable is swept linearly from the starting to the ending value.

OCT Sweep by octaves

The sweep variable is swept logarithmically by octaves.

DEC Sweep by decades

The sweep variable is swept logarithmically by decades.

DATA Sweep values from a table

Sweep variables are applied based on the rows of a data table. This format allows magnitude and phase to be swept in addition to frequency. If using this format, then the V(OUTPUT <, REF>) and SRC arguments are still needed on the .NOISE line.

points value

Specifies the number of points in the sweep, using an integer greater than or equal to 1.

start frequency value

end frequency value

The end frequency value must not be less than the start frequency value, and both must be greater than zero. The whole sweep must include at least one point.

Comments

Noise analysis is a linear analysis. The simulator calculates the noise response by linearizing the circuit around the bias point.

If specifying the sweep points using the `DATA` type, one can also sweep the magnitude and phase of an AC source, as well as the values of linear model parameters. However, unlike the use of `DATA` for `.STEP` and `.DC`, it is not possible to sweep nonlinear device parameters. This is because changing other nonlinear device parameters would alter the correct DCOP solution, and the `NOISE` sweep happens after the DCOP calculation in the analysis flow. To sweep a nonlinear device parameter on a `NOISE` problem, add a `.STEP` command to the netlist to provide an outer parametric sweep around the analysis.

If `.DATA` is used with `.NOISE` then the integrals for the total input noise and total output noise will only be calculated, and sent to `stdout`, if the frequencies in the data table are monotonically increasing.

A `.PRINT NOISE` must be used to get the results of the `NOISE` sweep analysis. See Section 2.1.31.

Noise analysis is a relatively new feature to Xyce, so not all noise models have been supported.

Power calculations (`P(<device>` and `W(<device>`) are not supported for any devices for noise analysis. Current variables (e.g., `I(<device>`) are only supported for devices that have “branch currents” that are part of the solution vector. This includes the V, E, H and L devices. It also includes the voltage-form of the B device.

2.1.24. *.OP (Bias Point Analysis)*

The `.OP` command causes detailed information about the bias point to be printed.

General Form `.OP`

Comments This type of analysis can be specified by itself, in which case Xyce will run a nominal operating point. However, if specified with another analysis type, no additional operating point will be calculated, as most analyses require a DC operating point for initialization.

`.OP` outputs the parameters for all the device models and all the device instances present in the circuit. For large circuits, this can be a very large amount of output, so use with caution.

 If no analysis command is provided, `.OP` will run a DC Operating Point calculation (i.e., a DC analysis) with all the voltage sources left at their nominal (instance line) values.

 The Xyce `.OP` statement may provide less, or different, output than other simulators. For some of the missing quantities, a Xyce `.PRINT` line can give similar information. Nodal voltages are always available on a `.PRINT` line. Device currents for many devices are available on a `.PRINT` line using the lead current notation `(I(devicename))`. Similarly, device power is available on a `.PRINT` line via `P(devicename)` or `W(devicename)`. However, these capabilities are not supported in all devices. Table 2-36 shows which devices support these lead current and power notations. Currently, there is no way to print out internal capacitances.

2.1.25. *.OPTIONS Statements*

Set various simulation limits, analysis control parameters and output parameters. In general, they use the following format:

General Form `.OPTIONS <pkg> [<name>=<value>]*`

Examples `.OPTIONS TIMEINT ABSTOL=1E-8`

Arguments and Options

<code>pkg</code>	<code>DEVICE</code>	Device Model
	<code>DIAGNOSTIC</code>	Diagnostic Simulation Output
	<code>TIMEINT</code>	Time Integration
	<code>NONLIN</code>	Nonlinear Solver
	<code>NONLIN-TRAN</code>	Transient Nonlinear Solver
	<code>NONLIN-HB</code>	HB Nonlinear Solver
	<code>LOCA</code>	Continuation/Bifurcation Tracking
	<code>LINSOL</code>	Linear Solver
	<code>LINSOL-HB</code>	HB Linear Solver
	<code>LINSOL-AC</code>	AC Linear Solver
	<code>OUTPUT</code>	Output
	<code>RESTART</code>	Restart
	<code>SAMPLES</code>	Sampling analysis and non-intrusive Polynomial Chaos (PCE)
	<code>EMBEDEDSAMPLES</code>	EmbeddedSampling and non-intrusive Polynomial Chaos (PCE)
	<code>PCES</code>	Fully intrusive Polynomial Chaos (PCE)
	<code>SENSITIVITY</code>	Direct and Adjoint sensitivities
	<code>HBINT</code>	Harmonic Balance (HB)
	<code>DIST</code>	Distribution
	<code>MEASURE</code>	Measure
	<code>PARSER</code>	Parsing

`name`

`value`

The name of the parameter and the value it will be assigned.

Comments Exceptions to this format are the OUTPUT and RESTART options, which use their own format. They are defined under their respective descriptions.

The designator `pkg` refers loosely to a *module* in the code. For most designators, multiple `.OPTIONS` statements are allowed. So for example, the netlist may contain multiple `.OPTIONS DEVICE` commands, and Xyce will parse and apply all of them. If any parameters are specified more than once, Xyce will issue a warning. The warning will include which parameter value is being used.

The OUTPUT and RESTART options have a different enough format that they can only be specified once. Extra OUTPUT and RESTART option statements (beyond the first one) will be ignored.

`.OPTIONS` statements are only permitted in the top level of the netlist. Any `.OPTIONS` statements inside of subcircuits will result in a warning, and otherwise will be ignored.

2.1.25.1. `.OPTIONS DEVICE (Device Package Options)`

The device package parameters listed in Table 2-3 outline the options available for specifying device specific parameters. Some of these (DEFAS, DEFAD, TNOM etc.) have the same meaning as they do for the `.OPTION` line from Berkeley SPICE (3f5). Parameters which apply globally to all device models will be specified here. Parameters specific to a particular device instance or model are specified in section 2.3.

Table 2-3. Options for Device Package

Option	Description	Default
DEFAD	MOS Drain Diffusion Area	0.0
DEFAS	MOS Source Diffusion Area	0.0
DEFL	MOS Default Channel Length	1.0E-4
DEFW	MOS Default Channel Width	1.0E-4
DIGINITSTATE	This option controls the behavior of the Digital Latch (DLTCH), D Flip-Flop (DFF), JK Flip-Flop (JKFF) and T Flip-Flop (TFF) behavioral digital devices during the DC Operating Point (DCOP) calculations. See 2.3.28 for more details.	3
GMIN	Minimum Conductance	1.0E-12
MINRES	This is a minimum resistance to be used in place of the default zero value of semiconductor device internal resistances. It is only used when model specifications (<code>.MODEL</code> cards) leave the parameter at its default value of zero, and is not used if the model explicitly sets the resistance to zero.	0.0
MINCAP	This is a minimum capacitance to be used in place of the default zero value of semiconductor device internal capacitances. It is only used when model specifications (<code>.MODEL</code> cards) leave the parameter at its default value of zero, and is not used if the model explicitly sets the capacitance to zero.	0.0

Table 2-3. Options for Device Package

Option	Description	Default
TEMP	Temperature	27.0 °C (300.15K)
TNOM	Nominal Temperature	27.0 °C (300.15K)
NUMJAC	Numerical Jacobian flag (only use for small problems)	0 (FALSE)
VOLTLIM	Voltage limiting	1 (TRUE)
B3SOIVOLTLIM	BSIMSOI3 Voltage limiting. This flag is similar to VOLTLIM, except that it only applies to the BSIMSOI version 3 (the newer versions of the BSIM SOI do not have voltage limiting). Turning this off will often improve numerical robustness. Unlike VOLTLIM, turning this off does not disable the initial condition code in the BSIMSOI model.	1 (TRUE)
B3SOIGMINSCALING	This flag enables scaling of gmin in the BSIMSOI version 3 device model. When it is enabled, a scaling factor of 1e-6 is applied to the gmin value.	1 (TRUE)
icFac	This is a multiplicative factor which is applied to right-hand side vector loads of .IC initial conditions during the DCOP phase.	10000.0
MAXTimestep	Maximum time step size	1.0E+99
SMOOTHBSRC	This flag enables smooth transitions by adding a RC network to the output of ABM devices	0
RCCONST	This option controls the smoothness of the transitions if the SMOOTHBSRC flag is enabled. This is done by specifying the RC constant of the RC network	1e-9
<i>MOSFET Homotopy parameters</i>		
VDSSCALEMIN	Scaling factor for Vds	0.3
VGSTCONST	Initial value for Vgst	4.5 Volt
LENGTH0	Initial value for length	5.0e-6
WIDTH0	Initial value for width	200.0e-6
TOX0	Initial value for oxide thickness	6.0e-8
<i>Debug output parameters</i>		
DEBUGLEVEL	The higher this number, the more info is output	1
DEBUGMINTIMESTEP	First time-step debug information is output	0
DEBUGMAXTIMESTEP	Last time-step of debug output	65536
DEBUGMINTIME	Same as DEBUGMINTIMESTEP except controlled by time (sec.) instead of step number	0.0
DEBUGMAXTIME	Same as DEBUGMAXTIMESTEP except controlled by time (sec.) instead of step number	100.0

2.1.25.2. .OPTIONS DIAGNOSTIC (Diagnostic Simulation Output)

This option enables the output of diagnostic data during a simulation to aid in debugging circuit problems. There are three optional diagnostics that one can specify, Extrema Limit, Voltage Limit, Current Limit and a Discontinuity limit. Their behavior is as follows:

- **EXTREMALIMIT=*value*** If *value* is given then Xyce will output the node name and absolute value of the solution vector extrema when it exceeds *value* at each step.
- **VOLTAGELIMIT=*value*** If *value* is given then Xyce will output the voltage node names and values that exceed \pm *value* at each step.
- **CURRENTLIMIT=*value*** If *value* is given then Xyce will output the branch and lead current names and values that exceed \pm *value* at each step.
- **DISCLIMIT=*value*** If *value* is given then Xyce will output solution variables where the absolute value of the difference between the solution and the predictor (from transient history) exceed *value*.

Note that **EXTREMALIMIT** will only output one name and value per step while **VOLTAGELIMIT**, **CURRENTLIMIT** and **DISCLIMIT** can output many names and values per step. Xyce's diagnostic output will be sent to the diagnostic file set by **DIAGFILENAME** along with step information (time step in transient simulation and step number otherwise) and the status of **GMIN** or source-stepping used to obtain the DC operating point. If no filename is specified, then the default output file name will be the input netlist name plus the extension `.dia`. A user can examine the output to infer if the circuit simulation is performing as expected. Further examples of using diagnostic options can be found in chapter 10 of the Xyce User's Guide.

Table 2-4. Options for Diagnostic Output

Option	Description	Default
EXTREMA	Output extreme values occurring in the solution vector	true
EXTREMALIMIT	Output the absolute value of extrema that exceed EXTREMALIMIT	0.0
VOLTAGELIMIT	Output voltages that exceed \pm VOLTAGELIMIT	0.0
CURRENTLIMIT	Output branch and lead currents that that exceed \pm CURRENTLIMIT	0.0
DISCLIMIT	Output solution variables where the absolute value of the difference between the solution and the transient predictor exceed \pm DISCLIMIT	0.0
DIAGFILENAME	Save diagnostic data to a file named by DIAFILENAME	[input netlist].dia

2.1.25.3. .OPTIONS TIMEINT (Time Integration Options)

The time integration parameters listed in Table 2-5 give the available options for helping control the time integration algorithms for transient analysis.

Time integration options are set using the `.OPTIONS TIMEINT` command.

Table 2-5. Options for Time Integration Package.

Option	Description	Default
METHOD	<p>Time integration method. This parameter is only relevant when running Xyce in transient mode. Supported methods:</p> <ul style="list-style-type: none"> • trap or 7 (variable order Trapezoid) • gear or 8 (Gear method) 	trap or 7 (variable order Trapezoid)
RELTOL	Relative error tolerance	1.0E-03
ABSTOL	Absolute error tolerance	1.0E-06
RESTARTSTEPSCALE	This parameter is a scalar which determines how small the initial time step out of a breakpoint should be. In the current version of the time integrator, the first step after a breakpoint isn't subjected to much error analysis, so for very stiff circuits, this step can be problematic.	0.005
NLNEARCONV	This flag sets if "soft" failures of the nonlinear solver, when the convergence criteria are almost, but not quite, met, should result in a "success" code being returned from the nonlinear solver to the time integrator. If this is enabled, it is expected that the error analysis performed by the time integrator will be the sole determination of whether or not the time step is considered a "pass" or a "fail". This is on by default, but occasionally circuits need tighter convergence criteria.	0 (FALSE)
NLSMALLUPDATE	This flag is another "soft" nonlinear solver failure flag. In this case, if the flag is set, time steps in which the nonlinear solver stalls, and is using updates that are numerically tiny, can be considered to have converged by the nonlinear solver. If this flag is set, the time integrator is responsible for determining if a step should be accepted or not.	1 (TRUE)
RESETTRANLS	The nonlinear solver resets its settings for the transient part of the run to something more efficient (basically a simpler set of options with smaller numbers for things like max Newton step). If this is set to false, this resetting is turned off. Normally should be left as default.	1 (TRUE)
MAXORD	This parameter determines the maximum order of integration that time integrators will attempt. Setting this option does not guarantee that the integrator will integrate at this order, it just sets the maximum order the integrator will attempt. In order to guarantee a particular order is used, see the option MINORD below.	2 for variable order Trapezoid and Gear
MINORD	This parameter determines the minimum order of integration that time integrators will attempt to maintain. The integrator will start at Backward Euler and move up in order as quickly as possible to achieve MINORD and then it will keep the order above this. If MINORD is set at 2 and MAXORD is set at 2, then the integrator will move to second order as quickly as possible and stay there.	1

Table 2-5. Options for Time Integration Package.

Option	Description	Default
NEWLTE	<p>This parameter determines the reference value for relative convergence criterion in the local truncation error based time step control. The supported choices</p> <ul style="list-style-type: none"> • 0. The reference value is the current value on each node. • 1. The reference value is the maximum of all the signals at the current time. • 2. The reference value is the maximum of all the signals over all past time. • 3. The reference value is the maximum value on each signal over all past time. 	1
NEWBPSTEPPING	<p>This flag sets a new time stepping method after a break point. Previously, Xyce treats each breakpoint identically to the DCOP point, in which the initial time step out of the DCOP is made to be very very small, because the LTE calculation is unreliable. As a result, Xyce takes an incredibly small step out of each breakpoint and then tries to grow the stepsize from there. When NEWBPSTEPPING is set, Xyce can take a reasonable large step out of every non-DCOP breakpoint, and then just relies on the step control to ensure that the step is small enough. Note that the new time stepping method after a break point does not work well with the old LTE calculation since the old LTE calculation is conservative and it tends to reject the first time step out of a break point. We recommend to use newlte if you choose to use the new time stepping method out of a break point.</p>	1 (TRUE)
MASKIVARS	<p>This parameter masks out current variables in the local truncation error (LTE) based time step control.</p>	0 (FALSE)
ERROPTION	<p>This parameter determines if Local Truncation Error (LTE) control is turned on or not. If ERROPTION is on, then step-size selection is based on the number of Newton iterations nonlinear solve. For Trapezoid and Gear, if the number of nonlinear iterations is below NLMIN then the step is doubled. If the number of nonlinear iterations is above NLMAX then the step is cut by one eighth. In between, the step-size is left alone. Because this option can lead to very large time-steps, it is very important to specify an appropriate DELMAX option. If the circuit has breakpoints, then the option MINTIMESTEPSBP can also help to adjust the maximum time-step by specifying the minimum number of time points between breakpoints.</p>	0 (Local Truncation Error is used)
NLMIN	<p>This parameter determines the lower bound for the desired number of nonlinear iterations during a Trapezoid time or Gear integration solve with ERROPTION=1.</p>	3
NLMAX	<p>This parameter determines the upper bound for the desired number of nonlinear iterations during a Trapezoid time or Gear integration solve with ERROPTION=1.</p>	8

Table 2-5. Options for Time Integration Package.

Option	Description	Default
DELMAX	This parameter determines the maximum time step-size used with ERROPTION=1. If a maximum time-step is also specified on the .TRAN line, then the minimum of that value and DELMAX is used.	1e99
MINTIMESTEPSBP	This parameter determines the minimum number of time-steps to use between breakpoints. This enforces a maximum time-step between breakpoints equal to the distance between the last breakpoint and the next breakpoint divided by MINTIMESTEPSBP.	10
TIMESTEPSREVERSAL	This parameter determines whether time-steps are rejected based upon the step-size selection strategy in ERROPTION=1. If it is set to 0, then a step will be accepted with successful nonlinear solves independent of whether the number of nonlinear iterations is between NLMIN and NLMAX. If it is set to 1, then when the number of nonlinear iterations is above NLMAX, the step will be rejected and the step-size cut by one eighth and retried. If ERROPTION=0 (use LTE) then TIMESTEPSREVERSAL=1 (reject steps) is set.	0 (do not reject steps)
DOUBLEDCOPSTEP	TCAD devices by default will solve an extra "setup" problem to mitigate some of the convergence problems that TCAD devices often exhibit. This extra setup problem solves a nonlinear Poisson equation first to establish an initial guess for the full drift-diffusion(DD) problem. The name of this parameter refers to the fact that the code is solving two DC operating point steps instead of one. To solve only the nonlinear Poisson problem, then set DOUBLEDCOP=nl_poisson. To solve only the drift-diffusion problem (skipping the nonlinear Poisson), set DOUBLEDCOP=drift_diffusion. To explicitly set the default behavior, then set DOUBLEDCOP=nl_poisson, drift_diffusion.	Default value, for TCAD circuits, is a combination: nl_poisson, drift_diffusion. Default value, for non-TCAD circuits is a moot point. If no TCAD devices are present in the circuit, then there will not be an extra DCOP solve.
BREAKPOINTS	This parameter specifies a comma-separated list of timepoints that should be used as breakpoints. They do not replace the existing breakpoints already being set internally by Xyce, but instead will add to them.	N/A
BPENABLE	Flag for turning on/off breakpoints (1 = ON, 0 = OFF). It is unlikely anyone would ever set this to FALSE, except to help debug the breakpoint capability.	1 (TRUE)

Table 2-5. Options for Time Integration Package.

Option	Description	Default
EXITTIME	If this is set to nonzero, the code will check the simulation time at the end of each step. If the total time exceeds the exittime, the code will ungracefully exit. This is a debugging option, the point of which is to have the code stop at a certain time during a run without affecting the step size control. If not set by the user, it isn't activated.	-
EXITSTEP	Same as EXITTIME, only applied to step number. The code will exit at the specified step. If not set by the user, it isn't activated.	-

2.1.25.4. .OPTIONS NONLIN (Nonlinear Solver Options)

The nonlinear solver parameters listed in Table 2-6 provide methods for controlling the nonlinear solver for DC, transient and harmonic balance. Note that the nonlinear solver options for DCOP, transient and harmonic balance are specified in separate options statements, using `.OPTIONS NONLIN`, `.OPTIONS NONLIN-TRAN` and `.OPTIONS NONLIN-HB`, respectively. The defaults for `.OPTIONS NONLIN` and `.OPTIONS NONLIN-TRAN` are specified in the third and fourth columns of Table 2-6. The defaults for `.OPTIONS NONLIN-HB` are the same as the default settings given for `NONLIN-TRAN` with two exceptions. For `NONLIN-HB`, the default for `ABSTOL` is $1e-9$ and the default for `RHSTOL` is $1e-4$.

Table 2-6. Options for Nonlinear Solver Package.

Option	Description	NONLIN Default	NONLIN-TRAN Default
NOX	Use NOX nonlinear solver.	1 (TRUE)	0 (FALSE)
NLSTRATEGY	Nonlinear solution strategy. Supported Strategies: <ul style="list-style-type: none"> • 0 (Newton) • 1 (Gradient) • 2 (Trust Region) 	0 (Newton)	0 (Newton)
SEARCHMETHOD	Line-search method used by the nonlinear solver. Supported line-search methods: <ul style="list-style-type: none"> • 0 (Full Newton - no line search) • 1 (Interval Halving) • 2 (Quadratic Interpolation) • 3 (Cubic Interpolation) • 4 (More'-Thuente) 	0 (Full Newton)	0 (Full Newton)

Table 2-6. Options for Nonlinear Solver Package.

Option	Description	NONLIN Default	NONLIN-TRAN Default
CONTINUATION	<p>Enables the use of Homotopy/Continuation algorithms for the nonlinear solve. Options are:</p> <ul style="list-style-type: none"> • 0 (Standard nonlinear solve) • 1 (Natural parameter homotopy. See LOCA options list) • 2/mos (Specialized dual parameter homotopy for MOSFET circuits) • 3/gmin (GMIN stepping, similar to that of SPICE) • 34/sourcstep (Simultaneous source stepping) • 35/sourcstep2 (Sequential source stepping) 	0 (Standard nonlinear solve)	0 (Standard nonlinear solve)
ABSTOL	Absolute residual vector tolerance	1.0E-12	1.0E-06
RELTOL	Relative residual vector tolerance	1.0E-03	1.0E-02
DELTA_TOL	Weighted nonlinear-solution update norm convergence tolerance	1.0	0.33
RHSTOL	Residual convergence tolerance (unweighted 2-norm)	1.0E-06	1.0E-02
SMALLUPDATETOL	Minimum acceptable norm for weighted nonlinear-solution update	1.0E-06	1.0E-06
MAXSTEP	Maximum number of Newton steps	200	20
MAXSEARCHSTEP	Maximum number of line-search steps	2	2
IN_FORCING	Inexact Newton-Krylov forcing flag	0 (FALSE)	0 (FALSE)
AZ_TOL	Sets the minimum allowed linear solver tolerance. Valid only if IN_FORCING=1.	1.0E-12	1.0E-12
RECOVERYSTEPTYPE	<p>If using a line search, this option determines the type of step to take if the line search fails. Supported strategies:</p> <ul style="list-style-type: none"> • 0 (Take the last computed step size in the line search algorithm) • 1 (Take a constant step size set by RECOVERYSTEP) 	0	0
RECOVERYSTEP	Value of the recovery step if a constant step length is selected	1.0	1.0
DEBUGLEVEL	The higher this number, the more info is output	1	1
DEBUGMINTIMESTEP	First time-step debug information is output	0	0
DEBUGMAXTIMESTEP	Last time-step of debug output	99999999	99999999
DEBUGMINTIME	Same as DEBUGMINTIMESTEP except controlled by time (sec.) instead of step number	0.0	0.0
DEBUGMAXTIME	Same as DEBUGMAXTIMESTEP except controlled by time (sec.) instead of step number	1.0E+99	1.0E+99

2.1.25.5. .OPTIONS LOCA (Continuation and Bifurcation Tracking Package Options)

The continuation selections listed in Table 2-7 provide methods for controlling continuation and bifurcation analysis. These override the default settings that were given in the continuation package. This option block is only used if the nonlinear solver or transient nonlinear solver enable continuation through the CONTINUATION flag.

There are several specialized homotopy methods that can be set in the nonlinear solver options line, .options nonlin. One is MOSFET-based homotopy, which is specific to MOSFET circuits. This is specified using continuation=2 or continuation=mos. Another is GMIN stepping, which is specified using continuation=3 or continuation=gmin. Lastly, source stepping can be done simultaneously, using continuation=34 or continuation=sourcestep, or sequentially using continuation=35 or continuation=sourcestep2. For any of these methods, while it is possible to modify their default LOCA options, it is generally not necessary to do so. Note that Xyce automatically attempts GMIN stepping if the initial attempt to find the DC operating point fails. In addition, Xyce will attempt simultaneous source stepping if GMIN fails to find a DC operating point. If any of the specialized homotopy methods are specified in the netlist, Xyce will attempt to find a DC operating point only using that method.

LOCA options are set using the .OPTIONS LOCA command.

Table 2-7. Options for Continuation and Bifurcation Tracking Package.

Option	Description	Default
	Stepping algorithm to use:	
STEPPER	<ul style="list-style-type: none"> • 0 (Natural or Zero order continuation) • 1 (Arc-length continuation) 	0 (Natural)
	Predictor algorithm to use:	
PREDICTOR	<ul style="list-style-type: none"> • 0 (Tangent) • 1 (Secant) • 2 (Random) • 3 (Constant) 	0 (Tangent)
	Algorithm used to adjust the step size between continuation steps:	
STEPCONTROL	<ul style="list-style-type: none"> • 0 (Constant) • 1 (Adaptive) 	0 (Constant)
CONPARAM	Parameter in which to step during a continuation run	VA:V0
INITIALVALUE	Starting value of the continuation parameter	0.0
MINVALUE	Minimum value of the continuation parameter	-1.0E20
MAXVALUE	Maximum value of the continuation parameter	1.0E20
BIFPARAM	Parameter to compute during bifurcation tracking runs	VA:V0
MAXSTEPS	Maximum number of continuation steps (includes failed steps)	20

Table 2-7. Options for Continuation and Bifurcation Tracking Package.

Option	Description	Default
MAXNLITERS	Maximum number of nonlinear iterations allowed (set this parameter equal to the MAXSTEP parameter in the NONLIN option block)	20
INITIALSTEPsize	Starting value of the step size	1.0
MINSTEPsize	Minimum value of the step size	1.0E20
MAXSTEPsize	Maximum value of the step size	1.0E-4
AGGRESSIVENESS	Value between 0.0 and 1.0 that determines how aggressive the step size control algorithm should be when increasing the step size. 0.0 is a constant step size while 1.0 is the most aggressive.	0.0
RESIDUALCONDUCTANCE	If set to a nonzero (small) number, this parameter will force the GMIN stepping algorithm to stop and declare victory once the artificial resistors have a conductance that is smaller than this number. This should only be used in transient simulations, and <i>ONLY</i> if it is absolutely necessary to get past the DC operating point calculation. It is almost always better to fix the circuit so that residual conductance is not necessary.	0.0

2.1.25.6. .OPTIONS LINSOL (Linear Solver Options)

Xyce uses both sparse direct solvers as well as Krylov iterative methods for the solution of the linear equations generated by Newton’s method. For the advanced users, there are a variety of options that can be set to help improve these solvers. Transformations of the linear system have a “TR_” prefix on the flag. Many of the options for the Krylov solvers are simply passed through to the underlying Trilinos/AztecOO solution settings and thus have an “AZ_” prefix on the flag.

Linear solver options are set using the .OPTIONS LINSOL command.

Table 2-8. Options for Linear Solver Package.

Option	Description	Default
type	<p>Determines which linear solver will be used.</p> <ul style="list-style-type: none"> • KLU • KSparse • SuperLU (optional) • AztecOO • Belos • ShyLU (optional) <p>Note that while KLU, KSparse, and SuperLU (optional) are available for parallel execution they will solve the linear system in serial. Therefore they will be useful for moderate problem sizes but will not scale in memory or performance for large problems</p>	<p>KLU (Serial, Parallel < 10⁴ unknowns) AztecOO, (Parallel, ≥ 10⁴ unknowns)</p>

Table 2-8. Options for Linear Solver Package.

Option	Description	Default
prec_type	Determines which preconditioner will be used with an iterative linear solver <ul style="list-style-type: none"> • Ifpack <p>A preconditioner will not be used if a direct solver (KLU, KSparse, SuperLU) is specified.</p>	Ifpack (Ifpack_IlukGraph)
use_aztec_precond	Triggers use of native AztecOO preconditioners for the iterative linear solves	0 (FALSE)
use_ifpack_factory	Use Ifpack factory to create preconditioner instead of using Ifpack_IlukGraph	0 (FALSE)
ifpack_type	If using the Ifpack factory, use_ifpack_factory=1, which preconditioner is created <ul style="list-style-type: none"> • Amesos (Additive Schwarz w/ KLU subdomain solve) • ILU • ILUT 	Amesos
ShyLU_rthresh	Relative dropping threshold for Schur complement preconditioner (ShyLU only)	1.0E-03
<i>Transformation parameters</i>		
TR_partition	Perform load-balance partitioning on the linear system	0 (NONE, Serial) 1 (Isorropia, Parallel)
TR_partition_type	Type of load-balance partitioning on the linear system	HYPERGRAPH
TR_singleton_filter	Triggers use of singleton filter for linear system	0 (FALSE, Serial) 1 (TRUE, Parallel)
TR_amd	Triggers use of approximate minimum-degree (AMD) ordering for linear system	0 (FALSE, Serial) 1 (TRUE, Parallel)
TR_global_btf	Triggers use of block triangular form (BTF) ordering for linear system, requires TR_amd=0 and TR_partition=0	0 (FALSE)
TR_reindex	Reindexes linear system parallel global indices in lexicographical order, recommended with singleton filter	1 (TRUE)
TR_solvermap	Triggers remapping of column indices for parallel runs, recommended with singleton filter	1 (TRUE)
<i>Iterative linear solver parameters</i>		
adaptive_solve	Triggers use of AztecOO adaptive solve algorithm for preconditioning of iterative linear solves	0 (FALSE)
AZ_max_iter	Maximum number of iterative solver iterations	200

Table 2-8. Options for Linear Solver Package.

Option	Description	Default
AZ_precond	AztecOO iterative solver preconditioner flag (used only when use_aztec_precond=1)	AZ_dom_decomp (14)
AZ_solver	Iterative solver type	AZ_gmres (1)
AZ_conv	Convergence type	AZ_r0 (0)
AZ_pre_calc	Type of precalculation	AZ_recalc (1)
AZ_keep_info	Retain calculation info	AZ_true (1)
AZ_orthog	Type of orthogonalization	AZ_modified (1)
AZ_subdomain_solve	Subdomain solution for domain decomposition preconditioners	AZ_ilut (9)
AZ_ilut_fill	Approximate allowed fill-in factor for the ILUT preconditioner	2.0
AZ_drop	Specifies drop tolerance used in conjunction with LU or ILUT preconditioners	1.0E-03
AZ_reorder	Reordering type	AZ_none (0)
AZ_scaling	Type of scaling	AZ_none (0)
AZ_kspace	Maximum size of Krylov subspace	50
AZ_tol	Convergence tolerance	1.0E-9
AZ_output	Output level	AZ_none (0) 50 (if verbose build)
AZ_diagnostics	Diagnostic information level	AZ_none (0)
AZ_overlap	Schwarz overlap level for ILU preconditioners	0
AZ_rthresh	Diagonal shifting relative threshold for ILU preconditioners	1.0001
AZ_athresh	Diagonal shifting absolute threshold for ILU preconditioners	1.0E-04
output_ls	Write out linear system matrix and right-hand-side vector, post-transformation, to Matrix Market file every # solves	0 (no output)
output_base_ls	Write out linear system matrix and right-hand-side vector, pre-transformation, to Matrix Market file every # solves	0 (no output)
output_failed_ls	Write out linear system matrix and right-hand-side vector to Matrix Market file every # solves when linear solver fails (only available for direct solvers)	0 (no output)

2.1.25.7. .OPTIONS LINSOL-HB (Linear Solver Options)

For harmonic balance (HB) analysis, Xyce provides both iterative and direct methods for the solution of the steady state. Only matrix-free techniques are available for preconditioning the HB Jacobian with an iterative linear solver. The direct linear solver explicitly forms the HB Jacobian and solves the complex-valued linear system with the requested solver. For HB analysis, a reduced number of linear solver options are available, and are set using the .OPTIONS LINSOL-HB command.

Table 2-9. Options for Linear Solver Package for HB.

Option	Description	Default
type	Determines which linear solver will be used	AztecOO
	<ul style="list-style-type: none"> • AztecOO • Belos • Direct 	
prec_type	Determines which preconditioner will be used with an iterative linear solver	block_jacobi
	<ul style="list-style-type: none"> • block_jacobi 	
A preconditioner will not be used if type=Direct is specified		
block_jacobi_corrected	Enable one-step correction to the block_jacobi preconditioner.	0 (FALSE)
direct_solver	Determines which direct linear solver will be used if type=Direct is specified	LAPACK
	<ul style="list-style-type: none"> • LAPACK 	
AZ_kspace	Maximum size of Krylov subspace	50
AZ_max_iter	Maximum number of iterative solver iterations	200
AZ_tol	Convergence tolerance	1.0E-9
output_ls	Write out linear system matrix and right-hand-side vector to Matrix Market file every # solves	0 (no output)

2.1.25.8. .OPTIONS LINSOL-AC (Linear Solver Options)

For AC analysis, Xyce provides both iterative and direct methods for the solution of the linear equations. For the advanced users, there are a variety of options that can be set to help improve these solvers. Transformations of the linear system have a “TR_” prefix on the flag. Many of the options for the Krylov solvers are simply passed through to the underlying Trilinos/AztecOO solution settings and thus have an “AZ_” prefix on the flag.

Linear solver options are set using the .OPTIONS LINSOL-AC command. The available options are the same as those for .OPTIONS LINSOL.

2.1.25.9. .OPTIONS OUTPUT (Output Options)

The `.OPTIONS OUTPUT` command can be used to allow control of the output frequency of data to files specified by `.PRINT TRAN` commands.

One method is to specify output intervals. The format for this method is:

```
.OPTIONS OUTPUT INITIAL_INTERVAL=<interval> [<t0> <i0> [<t1> <i1>]* ]
```

where `INITIAL_INTERVAL=<interval>` specifies the starting interval time for output and `<tx> <ix>` specifies later simulation times `<tx>` where the output interval will change to `<ix>`. The solution is output at the exact intervals requested; this is done by interpolating the solution to the requested time points.

Another useful method for controlling the output frequency is to specify discrete output points.

```
.OPTIONS OUTPUT OUTPUTTIMEPOINTS=<t0>,<t1>,*
```

If this option is used, then only the specified time points will appear in the output file. No other points will be output, so files using this method can be very sparse. For this type of output, the output values are not interpolated. Instead, the specified output points are set as breakpoints in the time integrator, so the output values are computed directly.

In addition to controlling the frequency of output, it is also possible to use output options to suppress the header from standard format output files, and the footer from both standard and tecplot format output files.

```
.OPTIONS OUTPUT PRINTHEADER=<boolean> PRINTFOOTER=<boolean>
```

where setting the `PRINTHEADER` variable to “false” will suppress the header and `PRINTFOOTER` variable to “false” will suppress the footer. The `PRINTHEADER` option is only applicable to `.PRINT <analysis> FORMAT=<STD|GNU PLOT|SPLOT>` files. The `PRINTFOOTER` option is only applicable to `.PRINT <analysis> FORMAT=<STD|GNU PLOT|SPLOT|TEC PLOT>` files.

It can be convenient to have all the solution variables output to file during a transient run without specifying all of them on a `.PRINT TRAN` line. This can be accomplished with the `SNAPSHOTS` option available on the `.OPTIONS OUTPUT` line.

```
.OPTIONS OUTPUT SNAPSHOTS=<boolean>
```

where setting the `SNAPSHOTS` variable to “true” will print all solution variables to the output file, ignoring any solution nodes specified in the `.PRINT TRAN` line.

It is possible to add a `STEPNUM` column as the first column in the output file.

```
.OPTIONS OUTPUT ADD_STEPNUM_COL=<boolean>
```

where setting the `ADD_STEPNUM_COL` variable to “true” will add the `STEPNUM` column. The default is “false”. This option is applicable to `FORMAT=<STD|NOINDEX|GNU PLOT|SPLOT>` for any `.PRINT` line that supports `FORMAT=STD` output.

The default Xyce output for phase operators, such as `VP()`, `IP()`, `SP()`, `YP()` and `ZP()`, is in degrees. For compatibility with other simulators like Spice3f5 and ngspice, it is possible to change that operator output to use radians instead:

```
.OPTIONS OUTPUT PHASE_OUTPUT_RADIANS=<boolean>
```

The default value for this option is FALSE. If set to TRUE then the phase output will be in radians instead of degrees. This option also applies to the format for AC sensitivity output. It does not affect the output from a .FOUR analysis or a .FOUR measure though. Those two outputs are always in degrees.

2.1.25.10. .OPTIONS RESTART (Checkpointing Options)

The .OPTIONS RESTART command is used to control all checkpoint output and restarting.

The checkpointing form of the .OPTIONS RESTART command takes the following format:

General Format:

```
.OPTIONS RESTART [PACK=<0|1>] JOB=<job prefix>  
+ [INITIAL_INTERVAL=<initial interval time> [<t0> <i0> [<t1> <i1>]* ]]
```

PACK=<0|1> indicates whether the restart data will be byte packed or not. Parallel restarts must always be packed while Windows/MingW runs are always not packed. Otherwise, data will be packed by default unless explicitly specified. JOB=<job prefix> identifies the prefix for restart files. The actual restart files will be the job name with the current simulation time appended (e.g. name1e-05 for JOB=name and simulation time 1e-05 seconds). Furthermore, INITIAL_INTERVAL=<initial interval time> identifies the initial interval time used for restart output. The <tx> <ix> intervals identify times <tx> at which the output interval (ix) should change. This functionality is identical to that described for the .OPTIONS OUTPUT command.

Examples To generate checkpoints at every time step (default):

Example: .OPTIONS RESTART JOB=checkpt

To generate checkpoints every 0.1 μ s:

Example: .OPTIONS RESTART JOB=checkpt INITIAL_INTERVAL=0.1us

To generate unpacked checkpoints every 0.1 μ s:

Example: .OPTIONS RESTART PACK=0 JOB=checkpt INITIAL_INTERVAL=0.1us

To specify an initial interval of 0.1 μ s, at 1 μ s change to interval of 0.5 μ s, and at 10 μ s change to interval of 0.1 μ s:

Example:

```
.OPTIONS RESTART JOB=checkpt INITIAL_INTERVAL=0.1us 1.0us  
+ 0.5us 10us 0.1us
```

2.1.25.11. .OPTIONS RESTART (Restarting Options)

To restart from an existing restart file, specify the file by either `FILE=<restart file name>` to explicitly use a restart file or by `JOB=<job name> START_TIME=<specified name>` to specify a file prefix and a specified time. The time must exactly match an output file time for the simulator to correctly identify the correct file. To continue generating restart output files, `INITIAL_INTERVAL=<interval>` and following intervals can be appended to the command in the same format as described above. New restart files will be packed according to the previous restart file read in.

The restarting form of the `.OPTIONS RESTART` command takes the following format:

General Format:

```
.OPTIONS RESTART FILE=<restart file name>|JOB=<job name> START_TIME=<time>
+ [ INITIAL_INTERVAL=<interval> [<t0> <i0> [<t1> <i1>]* ]]
```

Examples Example restarting from checkpoint file at 0.133 μ s:

Example: `.OPTIONS RESTART JOB=checkpt START_TIME=0.133us`

To restart from checkpoint file at 0.133 μ s:

Example: `.OPTIONS RESTART FILE=checkpt0.000000133`

Restarting from 0.133 μ s and continue checkpointing at 0.1 μ s intervals:

Example:

```
.OPTIONS RESTART FILE=checkpt0.000000133 JOB=checkpt_again
+ INITIAL_INTERVAL=0.1us
```

2.1.25.12. .OPTIONS RESTART: special notes for use with two-level-Newton

Large parallel problems which involve power supply parasitics often require a two-level solve, in which different parts of the problem are handled separately. In most respects, restarting a two-level simulation is similar to restarting a conventional simulation. However, there are a few differences:

- When running with a two-level algorithm, Xyce requires (at least) two different input files. In order to do a restart of a two-level Xyce simulation, it is necessary to have an `.OPTIONS RESTART` statement in each file.
- It is necessary for the statements to be consistent. For example, the output times must be exactly the same, meaning the initial intervals must be exactly the same.
- Xyce will *not* check to make sure that the restart options used in different files match, so it is up to the user to ensure matching options.
- Finally, as each netlist that is part of a two-level solve will have its own `.OPTIONS RESTART` statement, that means that each netlist will generate and/or use its own set of restart files. As a result, the restart file name used by each netlist must be unique.

2.1.25.13. .OPTIONS SAMPLES (Sampling options)

The sampling selections listed in Table 2-10 provide methods for controlling Monte Carlo and Latin Hypercube Sampling methods.

SAMPLES options are set using the .OPTIONS SAMPLES command. They are only used if the netlist also includes a .SAMPLING statement.

Table 2-10. Options for Sampling Package.

Option	Description	Default
NUMSAMPLES	Total number of samples	0
SAMPLE_TYPE	Sampling type (MC or LHS)	MC
OUTPUTS	Comma separated list of outputs (anything that would be a valid .RESULT output command)	–
MEASURES	Comma separated list of measure names (must refer to .MEASURE commands in the netlist)	–
COVMATRIX	Covariance matrix specified in row major form as comma-separated double precision numbers.	–
SEED	Random seed	See footnote. ¹
OUTPUT_SAMPLE_STATS	Compute and outputs statistics for specified outputs and/or measures.	–
REGRESSION_PCE	Enable regression based PCE. If this is enabled, the randomly sampled points will be used to produce a PCE approximation using regression methods.	–
PROJECTION_PCE	Enable projection based PCE (quadrature). If this is enabled, a PCE approximation will be created using quadrature methods. The NUMSAMPLES parameter will be ignored, and the samples will be the quadrature points used by projection PCE.	–
RESAMPLE	Once the PCE coefficients are obtained, perform sampling on the PCE approximation	–
OUTPUT_PCE_COEFFS	Output the PCE coefficients	–
SPARSE_GRID	Use sparse grid methods if using projection PCE.	–
STDOUTPUT	Send sampling and PCE output to the terminal	–

2.1.25.14. .OPTIONS EMBEDDEDSAMPLES (Embedded Sampling options)

The sampling selections listed in Table 2-11 provide methods for controlling Embedded Sampling methods.

EMBEDDEDSAMPLES options are set using the .OPTIONS EMBEDDEDSAMPLES command. They are only used if the netlist also includes a .EMBEDDEDSAMPLING statement.

¹The seed can also be set using command line option, -randseed. The command line seed will override the netlist seed value. If the seed is not set in either the netlist or on the command line, then Xyce generates a seed internally. In all cases, Xyce will output text to the console indicating what seed is being used.

Table 2-11. Options for Embedded Sampling Package.

Option	Description	Default
NUMSAMPLES	Total number of samples	0
SAMPLE_TYPE	Sampling type (MC or LHS)	MC
OUTPUTS	Comma separated list of outputs (anything that would be a valid .PRINT output variable)	–
COVMATRIX	Covariance matrix specified in row major form as comma-separated double precision numbers.	–
SEED	Random seed	See footnote. ¹
OUTPUT_SAMPLE_STATS	Compute and outputs statistics for specified outputs.	–
REGRESSION_PCE	Enable regression based PCE. If this is enabled, the randomly sampled points will be used to produce a PCE approximation using regression methods.	–
PROJECTION_PCE	Enable projection based PCE (quadrature). If this is enabled, a PCE approximation will be created using quadrature methods. The NUMSAMPLES parameter will be ignored, and the samples will be the quadrature points used by projection PCE.	–
RESAMPLE	Once the PCE coefficients are obtained, perform sampling on the PCE approximation	–
OUTPUT_PCE_COEFFS	Output the PCE coefficients	–
SPARSE_GRID	Use sparse grid methods if using projection PCE.	–
STDOUTOUTPUT	Send sampling and PCE output to the terminal	–

2.1.25.15. .OPTIONS PCES (Fully intrusive PCE options)

The sampling selections listed in Table 2-12 provide methods for controlling Embedded Sampling methods.

PCES options are set using the .OPTIONS PCES command. They are only used if the netlist also includes a .PCE statement.

Table 2-12. Options for PCE Package.

Option	Description	Default
OUTPUTS	Comma separated list of outputs (anything that would be a valid .PRINT output variable)	–
COVMATRIX	Covariance matrix specified in row major form as comma-separated double precision numbers.	–

¹The seed can also be set using command line option, -randseed. The command line seed will override the netlist seed value. If the seed is not set in either the netlist or on the command line, then Xyce generates a seed internally. In all cases, Xyce will output text to the console indicating what seed is being used.

Table 2-12. Options for PCE Package.

Option	Description	Default
SAMPLE_TYPE	Sampling type (MC or LHS). This is only used if resampling is enabled.	MC
SEED	Random seed. This is only used if resampling is enabled.	See footnote. ¹
OUTPUT_SAMPLE_STATS	Compute and outputs statistics for specified outputs.	–
RESAMPLE	Once the PCE coefficients are obtained, perform sampling on the PCE approximation	–
OUTPUT_PCE_COEFFS	Output the PCE coefficients	–
SPARSE_GRID	Use sparse grid methods if using projection PCE.	–
STDOUTPUT	Send sampling and PCE output to the terminal	–

2.1.25.16. .OPTIONS SENSITIVITY (Direct and Adjoint Sensitivity Options)

The sensitivity selections listed in Table 2-13 provide methods for controlling direct and adjoint sensitivity analysis.

SENSITIVITY options are set using the .OPTIONS SENSITIVITY command. They are only used if the netlist also includes a .SENS statement.

Table 2-13. Options for Sensitivity Package.

Option	Description	Default
ADJOINT	Flag to enable adjoint sensitivity calculation	false
DIRECT	Flag to enable direct sensitivity calculation	false
OUTPUTSCALED	Flag to enable output of scaled sensitivities	false
OUTPUTUNSCALED	Flag to enable output of unscaled sensitivities	true
STDOUTPUT	Flag to enable output of sensitivities to std output	false
ADJOINTBEGINTIME	Start time for set of time steps over which to compute transient adjoints.	0.0
ADJOINTFINALTIME	End time for set of time steps over which to compute transient adjoints.	1.0e+99
ADJOINTTIMEPOINTS	List of comma-separated time points at which to compute transient adjoints.	–

¹The seed can also be set using command line option, -randseed. The command line seed will override the netlist seed value. If the seed is not set in either the netlist or on the command line, then Xyce generates a seed internally. In all cases, Xyce will output text to the console indicating what seed is being used.

2.1.25.17. .OPTIONS HBINT (Harmonic Balance Options)

The Harmonic Balance parameters listed in Table 2-14 give the available options for helping control the algorithm for harmonic balance analysis.

Harmonic Balance options are set using the .OPTIONS HBINT command.

Table 2-14. Options for HB.

Option	Description	Default
NUMFREQ	Number of harmonics to be calculated for each tone. It must have the same number of entries as .HB statement	10
STARTUPPERIODS	Number of periods to integrate through before calculating the initial conditions. This option is only used when TAHB=1.	0
SAVEICDATA	Write out the initial conditions to a file.	0
TAHB	This flag sets transient assisted HB. When TAHB=0, transient analysis is not performed to get an initial guess. When TAHB=1, it uses transient analysis to get an initial guess. For multi-tone HB simulation, the initial guess is generated by a single tone transient simulation. The first tone following .HB is used to determine the period for the transient simulation. For multi-tone HB simulation, it should be set to the frequency that produces the most nonlinear response by the circuit. When tahb = 2, the DC op is used as an initial guess	1
VOLTLIM	This flag sets voltage limiting for HB. During the initial guess calculation, which normally uses transient simulation, the voltage limiting flag is determined by .options device voltlim. During the HB phase, the voltage limiting flag is determined by .options hbint voltlim.	1
INTMODMAX	The maximum intermodulation product order used in the spectrum.	the largest value in the NUMFREQ list.
NUMPTS	Number of time points in the output	The total number of frequencies (positive, negative and DC).
SELECTHARMS	The truncation method used in multi-tone HB to select harmonics. Box, diamond and hybrid truncation methods are supported	hybrid

2.1.25.18. .OPTIONS DIST (Parallel Distribution Options)

The parameters listed in Table 2-15 give the available options for controlling the parallel distribution used in Xyce. There are three choices for distribution strategy.

The default distribution strategy is “first-come, first-served” (STRATEGY=0), which divides the devices found in the netlist into equal sized groups (in the order they are parsed) and distributes a group to each processor. This does not take into account the connectivity of the circuit or balance device model computation, and therefore can exhibit parallel imbalance for post-layout circuits that have a substantial portion of parasitic devices.

The “flat round-robin” strategy (STRATEGY=1) will generate the same distribution as the default strategy, but every parallel processor will participate in reading its portion of the netlist. This strategy provides a more scalable setup than the default strategy, but can only be applied to flattened (non-hierarchical) netlists.

The “device balanced” strategy (STRATEGY=2) will evenly divide each of the device types over the number of parallel processors, so each processor will have a balanced number of each model type. This alleviates the parallel imbalance in the device model computation that can be experienced with post-layout circuits. However, it does not take into account the circuit connectivity, so the communication will not be minimized by this strategy.

Table 2-15. Options for Parallel Distribution.

Option	Description	Default
	Parallel device distribution strategy	
STRATEGY	<ul style="list-style-type: none"> • 0 (First-Come, First-Served) • 1 (Flat Round-Robin) • 2 (Device Balanced) 	0

2.1.25.19. .OPTIONS FFT (FFT Options)

The parameters listed in Table 2-16 give the available options for controlling all of the .FFT statements in a given Xyce netlist.

If FFT_ACCURATE is set to 1 (true), which is the default, then Xyce will insert breakpoints at the sample times requested by the collection of .FFT lines in the netlist. This has been found to improve the accuracy of the .FFT analyses, at the possible expense of simulation speed. If FFT_ACCURATE is set to 0 (false), then interpolation is used to determine the output variable values at the specified sample times. If the -remeasure command line option is used to recalculate the .MEASURE FFT and/or .FFT statements for a .TRAN analysis, then FFT_ACCURATE is set to 0 during the re-measure operation. Finally, if .OPTIONS OUTPUT INITIAL_INTERVAL is used in the netlist then .OPTIONS FFT FFT_ACCURATE will also be set to 0.

If FFTOUT is set to 1 then additional metrics are output to both stdout and the <netlistName>.fft0 file for each .FFT line. In addition a sorted list of the 30 largest harmonics is output to stdout. Those additional metrics are as follows, where Section 2.1.8.3 provides detailed definitions for these metrics:

- Effective Number of Bits (ENOB)
- Spurious Free Dynamic Range (SFDR)
- Signal to Noise Ratio (SNR)
- Signal to Noise-and-Distortion Ratio (SNDR)

- Total Harmonic Distortion (THD)

The setting for `FFT_MODE` is used to control whether the Xyce FFT processing and output are more compatible with HSPICE (0) or Spectre (1). This setting affects the format of the window functions, the conversion from two-sided to one-sided results, and whether the default output for the magnitude values is normalized, or not. Section 2.1.8.1 gives more details.

Table 2-16. Options for FFT.

Option	Description	Default
<code>FFT_ACCURATE</code>	Insert breakpoints at the sample times requested by the collection of <code>.FFT</code> lines in the netlist	1 (true)
<code>FFTOUT</code>	Output additional metrics (ENOB, SFDR, SNR, SNDR and THD) and a sorted list of the 30 largest harmonics for each <code>.FFT</code> line	0 (false)
<code>FFT_MODE</code>	Controls whether the FFT calculations and output format are more compatible with HSPICE (0) or Spectre (1)	0

2.1.25.20. `.OPTIONS MEASURE` (Measure Options)

The parameters listed in Table 2-17 give the available options for controlling all of the `.MEASURE` statements in a given Xyce netlist. The `MEASDGT`, `MEASFAIL` and `MEASOUT` options are included for HSPICE compatibility.

If given in the netlist, the setting for `MEASOUT` controls whether the `.mt#` (or `.ms#` or `.ma#`) files are made (1) or not (0). The `MEASOUT` setting takes precedence over the `MEASPRINT` setting (which is a Xyce-specific option) if both are given in the netlist. See Section 2.1.18.7 for more details then on how the `MEASPRINT` option interacts with the individual `.MEASURE` statements and the `-remeasure` command line option.

If given in the netlist, the setting for the `MEASDGT` overrides the `PRECISION` qualifiers given on individual `.MEASURE` lines. The default value for the `MEASDGT` option is different from in HSPICE.

The Xyce behavior for failed measures can be controlled via the `MEASFAIL` and `DEFAULT_VAL` options, as well as with the `DEFAULT_VAL` qualifiers on individual `.MEASURE` lines. The order of precedence is the `DEFAULT_VAL` option and then the `DEFAULT_VAL` qualifier on individual `.MEASURE` lines. If `MEASFAIL=0` then Xyce outputs the default value in the `.mt#` (or `.ms#` or `.ma#`) files for a failed measure. If `MEASFAIL=1` (or any other non-zero value) then Xyce outputs “FAILED” in the `.mt#` (or `.ms#` or `.ma#`) files for a failed measure. If given in the netlist, the setting for the `DEFAULT_VAL` option overrides the `DEFAULT_VAL` qualifiers given on individual `.MEASURE` lines. The `DEFAULT_VAL` option and the `DEFAULT_VAL` qualifiers can be set to any real number. For all of these cases, Xyce will print “FAILED” to the standard output for a failed measure. As a final note, the `FOUR` measure is a special case since it produces multiline output. Failed `FOUR` measures will be reported as “FAILED” in the `.mt#` (or `.ms#` or `.ma#`) files, irrespective of the various `MEASFAIL` and `DEFAULT_VAL` settings.

The `USE_CONT_FILES` option controls whether each `AC_CONT`, `DC_CONT`, `NOISE_CONT` or `TRAN_CONT` mode measure uses a separate output file for its results, or not. Section 2.1.19.1 provides more details and an example netlist for this options setting.

For backwards compatibility with previous Xyce versions, `USE_LTTM` has been added. This option defaults to 0, which uses the new version of the `TRIG-TARG` measure; while setting it to 1 will use the old version of

the TRIG-TARG measure for all TRIG-TARG measures in the netlist. If the FRAC_MAX qualifier is used on a TRIG-TARG line then Xyce will automatically default to USE_LTTM=1 for that particular measure line. It is anticipated that this option setting will be removed at some point.

Table 2-17. Options for MEASURE.

Option	Description	Default
DEFAULT_VAL	Default value for “failed measures” in the .mt# (or .ms# or .ma#) files.	-1
MEASDGT	Precision for all .MEASURE statements. This value applies to the output to both the .mt# (or .ms# or .ma#) files and the standard output.	6
MEASFAIL	Specify output format for failed measures	1
MEASOUT	Control whether the .mt0 file is made or not	1
	Measure Output	
MEASPRINT	<ul style="list-style-type: none"> • ALL (Output measure information to both file(s) and stdout) • STDOUT (Output measure information to stdout only) • NONE (Suppress all measure output) 	ALL
USE_CONT_FILES	Specifies whether “continuous” mode measures use separate output files for each such measure	1 (TRUE)
USE_LTTM	Use the “Legacy Trig-Trag Mode“. This option is included for backwards compatibility with previous Xyce versions. It may be removed in the future	0 (FALSE).

2.1.25.21. .OPTIONS PARSER (Parser Options)

The parameter listed in Table 2-18 gives the available option for netlist parsing.

Table 2-18. Options for Parsing.

Option	Description	Default
MODEL_BINNING	Enable model binning during netlist parsing. See Section 2.1.21 for more details on how model binning works in Xyce.	TRUE
SCALE	Scale factor for geometric parameters such as MOSFET length and width. This can also be specified as .option scale (singular .OPTION and omitting the keyword PARSER) for compatibility with other simulators. See section 2.1.21 for an example usage.	1.0

2.1.26. **.PARAM (Parameter)**

User defined parameter or function that can be used in expressions throughout the netlist.

General Form `.PARAM <name>[(arg*)]=<value> [[,]<name>[(arg*)]=<value>]*`

Examples

```
.PARAM A_Param=1K
.PARAM B_Param={A_Param*PI}
.PARAM FTEST(X)='2*X' B=12.0 FTEST2(X)='3*X'
.PARAM SUM(A,B,C)={A+B+C}
.PARAM A=1, B=2
.PARAM C=AGAUSS(1,0.1,0.1)
```

Arguments and

Options

name

Parameter name. Parameters may be redefined. If the same parameter name is used on multiple parameters, Xyce by default will use the last parameter of that name. By default, no warning will be emitted. To change this behavior, one can use the `-redefined_param` command line option, described in section 3-1.

arg Optional arguments to parameter that is a function. `.PARAM` arguments cannot be node names. The number of arguments in the use of a function must agree with the number in the definition. Parameters, TIME, FREQ, and other functions are allowed in the body of function definitions. Two constants EXP and PI cannot be used a argument names. These constants are equal to e and π , respectively, and cannot be redefined.

value

The value may be a number or an expression. If it is an expression, it can be surrounded by curly braces (`{ }`), single quotes (`'`), or without delimiters. Curly braces were originally required by the Xyce parser, so if one encounters parsing difficulties, consider surrounding expression values with them.

Comments

Parameters defined using `.PARAM` only have a few restrictions on their usage. In earlier versions of Xyce they were handled as constants that were evaluated during parsing. This is no longer the case, and parameters can now have their values change throughout the calculation. A `.PARAM` defined in the top level netlist is equivalent to a `.GLOBAL_PARAM`, and they can be combined as needed. Thus, you may use parameters defined by `.PARAM` in expressions used to define global parameters, and you may also use global parameters in `.PARAM` definitions.

It is legal for parameters to depend on special variables such as TIME, FREQ, TEMP and VT variables. However, it is not legal for parameters to depend on solution variables such as voltage nodes or independent source currents.

Parameters defined using `.PARAM` can be modified directly by various analyses, such as `.DC`, `.STEP`, `.SAMPLING` and `.EMBEDEDSAMPLING`, subject to scoping rules. This will not work, however, for parameters defined as functions.

Multiple parameters (conventional or function) can be specified on the same netlist line. Parameters on the same line can optionally be separated using commas. If Xyce has difficulty parsing a multi-parameter `.PARAM` line, consider adding commas if they are not already present.

To load an external data file with time voltage pairs of data on each line into a global parameter, use this syntax:

```
.GLOBAL_PARAM extdata = {tablefile("filename")}
```

or

```
.GLOBAL_PARAM extdata = {table("filename")}
```

where `filename` would be the name of the file to load. Other interpolators that can read in a data table from a file include `fasttable`, `spline`, `akima`, `cubic`, `wodicka` and `bli`. See 2.2 for further information.

There are several reserved words that may not be used as names for parameters. These reserved words are:

- Time
- Freq
- Hertz
- Vt
- Temp
- Temper
- GMIN

The scoping rules for parameters are:

- If a `.PARAM` statement is included in the main circuit netlist, then it is accessible from the main circuit and all subcircuits.
- `.PARAM` statements defined within a subcircuit are scoped to that subcircuit definition. So, their parameters are only accessible within that subcircuit definition, as well as within “nested subcircuits” also defined within that subcircuit definition.
- Parameters defined via `.PARAM` statements can be modified by the various UQ analysis techniques (`.STEP`, `.SAMPLING`, etc) but this only works for `.PARAM` that have been defined in the top level netlist. Parameters defined inside of subcircuits cannot be modified directly by these analyses, but they can be modified indirectly via dependence on other globally scoped parameter.

Additional illustrative examples of scoping are given in the “Working with Subcircuits and Models” section of the Xyce Users’ Guide [1].

2.1.27. *.PCE (Fully Intrusive Polynomial Chaos Expansion (PCE) Analysis)*

Calculates a fully intrusive Polynomial Chaos Expansion (PCE) analysis (for `.DC` or `.TRAN` only) to propagate uncertainty from a set of uncertain inputs to uncertain outputs. This involves evaluating the circuit at a set of parameter values corresponding to quadrature points used by the PCE algorithm. The loop over parameter values happens at the inner-most part of the calculation, so all samples are propagated simultaneously.

This fully-intrusive form of PCE is an experimental analysis method. Non-intrusive methods of PCE are also available in Xyce and will usually be a better choice. The non-intrusive methods are used in combination with `.SAMPLING` and/or `.EMBEDDEDSAMPLING`. Of those other methods, the behavior of `.PCE` most closely resembles that of `.EMBEDDEDSAMPLING` with `projection_pce=true`.

General Form

```
.PCE
+ param=<parameter name>,[parameter name]*
+ type=<parameter type>,[parameter type]*
+ means=<mean>,[mean]*
+ std_deviations=<standard deviation>,[standard deviation]*
+ lower_bounds=<lower bound>,[lower bound]*
+ upper_bounds=<upper bound>,[upper bound]*
+ alpha=<alpha>,[alpha]*
+ beta=<beta>,[beta]*
```

Examples

```
.PCE
+ param=R1
+ type=normal
+ means=3K
+ std_deviations=1K

.PCE
+ param=R1,R2
+ type=uniform,uniform
+ lower_bounds=1K,2K
+ upper_bounds=5K,6K

.PCE useExpr=true

.options PCES
+ OUTPUTS={R1:R},{V(1)}
```

Arguments and Options

param
Names of the parameters to be sampled. This may be any of the parameters that are valid for `.STEP`, including device instance, device model, or global parameters. If more than one parameter, then specify as a comma-separated list.

type

Distribution type for each parameter. This may be uniform, normal or gamma. If more than one parameter, then specify as a comma-separated list.

means

If using normal distributions, the mean for each parameter must be specified. If more than one parameter, then specify as a comma-separated list.

std_deviations

If using normal distributions, the standard deviation for each parameter must be specified. If more than one parameter, then specify as a comma-separated list.

lower_bounds

If using uniform distributions, the lower bound must be specified. This is optional for normal distributions. If used with normal distributions, may alter the mean and standard deviation. If more than one parameter, then specify as a comma-separated list.

upper_bounds

If using uniform distributions, the upper bound must be specified. This is optional for normal distributions. If used with normal distributions, may alter the mean and standard deviation. If more than one parameter, then specify as a comma-separated list.

alpha

If using gamma distributions, the alpha value for each parameter must be specified. If more than one parameter, then specify as a comma-separated list.

beta

If using gamma distributions, the beta value for each parameter must be specified. If more than one parameter, then specify as a comma-separated list.

useExpr

If this argument is set to true, then the sampling algorithm will set up random inputs from expression operators such as AGAUSS and AUNIF. In this case it will also ignore the list of parameters on the .PCE command line. For a complete description of expression-based random operators, see the expression documentation in section 2.2.

Comments

In addition to the .PCE command, this analysis requires a .options PCES command as well. The .PCE command specifies parameters and their attributes, either using the useExpr option, or with comma-separated lists. The .options PCES command specifies the outputs for which to compute statistics. To see the details of the .options PCES command, see table 2-12.

On the .PCE command line, if not using useExpr, parameters and their attributes must be specified using comma-separated lists. The comma-separated lists must all be the same length.

The .PRINT PCE command provides output based on the contents of those print-lines, and also the OUTPUT arguments on the .OPTIONS PCES line.

If the `OUTPUT_SAMPLE_STATS` argument on a `.PRINT PCE` line is set to “true” then the statistics for the `MEAN`, `MEANPLUS`, `MEANMINUS`, `STDDEV` and `VARIANCE` will be output for each variable in the `OUTPUT` argument. If the `OUTPUT_ALL_SAMPLES` argument on a `.PRINT PCE` line is set to “true” then the values of all quadrature points, for each variable requested in the `OUTPUTS` argument, will be output.

2.1.28. `.PREPROCESS REPLACEGROUND` (*Ground Synonym*)

The purpose of ground synonym replacement is to treat nodes with the names GND, GND!, GROUND or any capital/lowercase variant thereof as synonyms for node 0. The general invocation is

General Form `.PREPROCESS REPLACEGROUND <bool>`

Arguments and Options

`bool`

If TRUE, Xyce will treat all instances of GND, GND!, GROUND, or any capital/lowercase variant thereof, as synonyms for node 0. If FALSE, Xyce will consider each term as a separate node. Only one `.PREPROCESS REPLACEGROUND` statement is permissible in a given netlist file.

2.1.29. **.PREPROCESS REMOVEUNUSED (Removal of Unused Components)**

If a given netlist file contains devices whose terminals are all connected to the same node (e.g., R2 1 1 1M), it may be desirable to remove such components from the netlist before simulation begins. This is the purpose of the command

General Form `.PREPROCESS REMOVEUNUSED [<value>]`

Arguments and Options

`value`

is a list of components separated by commas. The allowed values are

C	Capacitor
D	Diode
I	Independent Current Source
L	Inductor
M	MOSFET
Q	BJT
R	Resistor
V	Independent Voltage Source

Examples `.PREPROCESS REMOVEUNUSED R,C`

`.PREPROCESS` will attempt to search for all resistors and capacitors in a given netlist file whose individual device terminals are connected to the same node and remove these components from the netlist before simulation ensues. A list of components that are supported for removal is given above. Note that for MOSFETS and BJTs, three terminals on each device (the gate, source, and drain in the case of a MOSFET and the collector, base, and emitter in the case of a BJT) must be the same for the device to be removed from the netlist. As before, only one `.PREPROCESS REMOVEUNUSED` line is allowed in a given netlist file.

2.1.30. **.PREPROCESS ADDRESSISTORS (Adding Resistors to Dangling Nodes)**

We refer to a *dangling node* as a circuit node in one of the following two scenarios: either the node is connected to only one device terminal, and/or the node has no DC path to ground. If several such nodes exist in a given netlist file, it may be desirable to automatically append a resistor of a specified value between the dangling node and ground. To add resistors to nodes which are connected to only one device terminal, one may use the command

General Form

```
.PREPROCESS ADDRESSISTORS ONETERMINAL <value>
```

Arguments and Options

value
is the value of the resistor to be placed between nodes with only one device terminal connection and ground. For instance, the command

Examples

```
.PREPROCESS ADDRESSISTORS ONETERMINAL 1G
```

will add resistors of value 1G between ground and nodes with only one device terminal connection and ground. The command

Examples

```
.PREPROCESS ADDRESSISTORS NODCPATH <value>
```

acts similarly, adding resistors of value <VALUE> between ground and all nodes which have no DC path to ground.

The `.PREPROCESS ADDRESSISTORS` command is functionally different from either of the prior `.PREPROCESS` commands in the following way: while the other commands augment the netlist file for the current simulation, a `.PREPROCESS ADDRESSISTORS` statement creates an auxiliary netlist file which explicitly contains a set of resistors that connect dangling nodes to ground. If the original netlist file containing a `.PREPROCESS ADDRESSISTORS` statement is called `filename`, invoking Xyce on this file will produce a file `filename_xyce.cir` which contains the resistors that connect dangling nodes to ground. One can then run Xyce on this file to run a simulation in which the dangling nodes are tied to ground. Note that, in the original run on the file `filename`, Xyce will continue to run a simulation as usual after producing the file `filename_xyce.cir`, but this simulation will *not* include the effects of adding resistors between the dangling nodes and ground. Refer to the Xyce Users' Guide [1] for more detailed examples on the use of `.PREPROCESS ADDRESSISTOR` statements.

Note that it is possible for a node to have one device terminal connection and, simultaneously, have no DC path to ground. In this case, if both a `ONETERMINAL` and `NODCPATH` command are invoked, only the resistor for the `ONETERMINAL` connection is added to the netlist; the `NODCPATH` connection is omitted.

As before, each netlist file is allowed to contain only one `.PREPROCESS ADDRESSISTORS ONETERMINAL` and one `.PREPROCESS ADDRESSISTORS NODCPATH` line each, or else Xyce will exit in error.

2.1.31. **.PRINT (Print output)**

Send analysis results to an output file.

Xyce allows multiple output files to be created during the run and supports several options for each.

General Form .PRINT <print type> [FILE=<output filename>]
 + [FORMAT=<STD|NOINDEX|PROBE|TECPLOT|RAW|CSV|GNUPLLOT|SPLOT>]
 + [WIDTH=<print field width>]
 + [PRECISION=<floating point output precision>]
 + [FILTER=<absolute value below which a number outputs as 0.0>]
 + [DELIMITER=<TAB|COMMA|SEMICOLON|COLON|"string">]
 + [TIMESCALEFACTOR=<real scale factor>]
 + [OUTPUT_SAMPLE_STATS=<boolean>] [OUTPUT_ALL_SAMPLES=<boolean>]
 + <output variable> [output variable]*

Examples .print tran format=tecplot V(1) I(Vsrc) {V(1)*(I(Vsrc)**2.0)}

 .PRINT TRAN FORMAT=PROBE FILE=foobar.csd V(1) {abs(V(1))-5.0}

 .PRINT DC FILE=foobar.txt WIDTH=19 PRECISION=15 FILTER=1.0e-10
 + I(VSOURCE5) I(VSOURCE6)

 .print tran FORMAT=RAW V(1) I(Vsrc)

 R1 1 0 100
 X1 1 2 3 MySubcircuit
 V1 3 0 1V
 .SUBCKT MYSUBCIRCUIT 1 2 3
 R1 1 2 100K
 R2 2 4 50K
 R3 4 3 1K
 .ENDS

 .PRINT DC V(X1:4) V(2) I(V1)

Arguments and Options

print type

A print type is the name of an analysis, one of the analysis specific print subtypes, or a specialized output command.

Analysis	Print Type	Description
.AC	AC	Sets default variable list and formats for print subtypes
.AC	AC_IC	Overrides variable list and format for AC initial conditions
.DC	DC	
.EMBEDEDDED SAMPLING	ES	
.HB	HB	
.HB	HB_FD	Overrides variable list and format for HB frequency domain
.HB	HB_IC	Overrides variable list and format for HB initial conditions
.HB	HB_STARTUP	Overrides variable list and format for HB start up
.HB	HB_TD	Overrides variable list and format for HB time domain
.NOISE	Noise	Outputs Noise spectral density curves
.TRAN	TRAN	
<i>Specialized Output Commands</i>		
<i>Homotopy</i>	HOMOTOPY	Sets variable list and format for homotopy
.SENS	SENS	Sets variable list and format for sensitivity

A netlist may contain many .PRINT commands, but only commands with analysis types which are appropriate for the analysis being performed are processed. This feature allows you to generate multiple formats and variable sets in a single analysis run.

For analysis types that generate multiple output files, the print subtype allows you to specify variables and output parameters for each of those output files. If there is no .PRINT <subtype> provided in the net list, the variables and parameters from the analysis type will be used.

FORMAT=<STD | NOINDEX | PROBE | TECPLOT | RAW | CSV | GNUPLOT | PLOT>

The output format may be specified using the FORMAT option. The STD format outputs the data divided up into data columns. The NOINDEX format is the same as the STD format except that the index column is omitted. The PROBE format specifies that the output should be formatted to be compatible with the PSpice Probe plotting utility. The TECPLOT format specifies that the output should be formatted to be compatible with the Tecplot plotting program. The RAW format specifies that the output should comply with the SPICE binary rawfile format. The -a command line option, in conjunction with FORMAT=RAW on the .PRINT line, can then be used to output an ASCII rawfile. The CSV format specifies that the output file should be a

comma-separated value file with a header indicating the variables printed in the file. It is similar to, but not identical to using DELIMITER=COMMA; the latter will also print a footer that is not compatible with most software that requires CSV format. The GNUPLOT (or SPLIT) format is the same as the STD format except that if .STEP is used then two (or one) blank lines are inserted before the data for steps 1,2,3,... where the first step is step 0. The SPLIT format is useful for when the “split” command in gnuplot is used to produce 3D perspective plots.

FILE=<output filename>

Specifies the name of the file to which the output will be written. See the “Results Output and Evaluation Options” section of the Xyce Users’ Guide [1] for more information on how this feature works for analysis types (e.g., AC and HB) that can produce multiple output files.

WIDTH=<print field width>

Controls the output width used in formatting the output.

PRECISION=<floating point precision>

Number of floating point digits past the decimal for output data.

FILTER=<filter floor value>

Used to specify the absolute value below which output variables will be printed as 0.0.

DELIMITER=<TAB | COMMA | SEMICOLON | COLON | "string">

Used to specify an alternate delimiter in the STD, NOINDEX, GNUPLOT or CSV format output. In addition to TAB, COMMA, SEMICOLON and COLON, the delimiter can also be specified using a quoted character string. When this option is used, that string is the delimiter.

TIMESCALEFACTOR=<real scale factor>

Specify a constant scaling factor for time. Time is normally printed in units of seconds, but if one would like the units to be milliseconds, then set TIMESCALEFACTOR=1000.

OUTPUT_SAMPLE_STATS=<boolean>

Output the sample statistics for an EMBEDDEDSAMPLING analysis. This argument is only supported for .PRINT ES. Its default value is true. Section 2.1.5 has more details.

OUTPUT_ALL_SAMPLES=<boolean>

Output all of the sample values for an EMBEDDEDSAMPLING analysis. This argument is only supported for .PRINT ES. Its default value is false. Section 2.1.5 has more details.

<output variable>

Following the analysis type and other options is a list of output variables. There is no upper bound on the number of output variables. The output is divided up into data columns and output according to any specified options (see options given above). Output variables can be specified as:

- V(<circuit node>) to output the voltage at <circuit node>

- `V(<circuit node>, <circuit node>)` to output the voltage difference between the first `<circuit node>` and second `<circuit node>`
- `I(<device>)` to output current through a two terminal device
- `I<lead abbreviation>(<device>)` to output current into a particular lead of a three or more terminal device (see the Comments, below, for details)
- `P(<device>)` or `W(<device>)` to output the power dissipated/generated in a device. At this time, not all devices support power calculations. In addition, the results for semiconductor devices (D, J, M, Q and Z devices) and the lossless transmission device (T device) may differ from other simulators. Consult the Features Supported by Xyce Device Models table in section 2.3 and the individual sections on each device for more details. Finally, power calculations are not supported for any devices for `.AC` and `.NOISE` analyses.
- `N(<device internal variable>)` to output a specific device's internal variable. (The comments section below has more detail on this syntax.)
- `{expression}` to output an expression
- `<device>:<parameter>` to output a device parameter
- `<model>:<parameter>` to output a model parameter

When the analysis type is AC, HB or Noise, additional output variable formats are available:

- `VR(<circuit node>)` to output the real component of voltage response at a point in the circuit
- `VI(<circuit node>)` to output the imaginary component of voltage response at a point in the circuit
- `VM(<circuit node>)` to output the magnitude of voltage response
- `VP(<circuit node>)` to output the phase of voltage response in degrees
- `VDB(<circuit node>)` to output the magnitude of voltage response in decibels.
- `VR(<circuit node>, <circuit node>)` to output the real component of voltage response between two nodes in the circuit
- `VI(<circuit node>, <circuit node>)` to output the imaginary component of voltage response between two nodes in the circuit
- `VM(<circuit node>, <circuit node>)` to output the magnitude of voltage response between two nodes in the circuit
- `VP(<circuit node>, <circuit node>)` to output the phase of voltage response between two nodes in the circuit in degrees

- VDB(<circuit node>, <circuit node>) to output the magnitude of voltage response between two nodes in the circuit, in decibels
- IR(<device>) to output the real component of the current through a two terminal device
- II(<device>) to output the imaginary component of the current through a two terminal device
- IM(<device>) to output the magnitude of the current through a two terminal device
- IP(<device>) to output the phase of the current through a two terminal device in degrees
- IDB(<device>) to output the magnitude of the current through a two terminal device in decibels.

In AC and Noise analyses, outputting a voltage node without any of these optional designators results in output of the real and imaginary parts of the signal. Note that under AC and Noise analyses, current variables are only supported for devices that have “branch currents” that are part of the solution vector. This includes the V, E, H and L devices. It also includes the voltage-form of the B device.

Note that when using the variable list for time domain output, usage of frequency domain functions like VDB can result in -Inf output being written to the output file. This is easily solved by defining the time domain equivalent command to specify the correct output for time domain data.

Further explanation of the current specifications is given in comments section below.

When a .LIN analysis is done then additional output variable formats are available via the .PRINT AC line, where <index1> and <index2> must both be greater than 0 and also both less than or equal to the number of ports in the netlist:

- SR(<index1>, <index2>) to output the real component of an S-parameter
- SI(<index1>, <index2>) to output the imaginary component of an S-parameter
- SM(<index1>, <index2>) to output the magnitude of an S-parameter
- SP(<index1>, <index2>) to output the phase of an S-parameter in degrees
- SDB(<index1>, <index2>) to output the magnitude of an S-parameter in decibels.
- YR(<index1>, <index2>) to output the real component of a Y-parameter
- YI(<index1>, <index2>) to output the imaginary component of a Y-parameter

- YM(<index1>, <index2>) to output the magnitude of a Y-parameter
- YP(<index1>, <index2>) to output the phase of a Y-parameter in degrees
- YDB(<index1>, <index2>) to output the magnitude of a Y-parameter in decibels.
- ZR(<index1>, <index2>) to output the real component of a Z-parameter
- ZI(<index1>, <index2>) to output the imaginary component of a Z-parameter
- ZM(<index1>, <index2>) to output the magnitude of a Z-parameter
- ZP(<index1>, <index2>) to output the phase of a Z-parameter in degrees
- ZDB(<index1>, <index2>) to output the magnitude of a Z-parameter in decibels.

When the analysis type is Noise, additional output variable formats are available via the .PRINT NOISE line for devices that support stationary noise.

- INOISE to output the input noise contributions
- ONOISE to output the output noise contributions
- DNI(<deviceName>) to output the input noise contribution from device <deviceName>
- DNI(<deviceName>, <noiseSource>) to output the input noise contribution from source <noiseSource> for device <deviceName>
- DNO(<deviceName>) to output the output noise contribution from device <deviceName>
- DNO(<deviceName>, <noiseSource>) to output the output noise contribution from source <noiseSource> for device <deviceName>

Comments

- Currents are positive flowing from node 1 to node 2 for two node devices, and currents are positive flowing into a particular lead for multi-terminal devices.
- <circuit node> is simply the name of any node in your top-level circuit, or <subcircuit name>:<node> to reference nodes that are internal to a subcircuit.
- <device> is the name of any device in your top-level circuit, or <subcircuit name>:<device> to reference devices that are internal to a subcircuit.
- <lead abbreviation> is a single character designator for individual leads on a device with three or more leads. For bipolar transistors these are: c (collector), b (base), e (emitter), and s (substrate). For MOSFETs, JFETs, and MESFETs, lead abbreviations are: d (drain), g (gate), s (source), and for MOSFETs and JFETs, b (bulk). In addition to these standard leads, SOI and CMG MOSFETs

have e (bulk) nodes and SOI transistors have optional b (body) nodes whose lead currents may also be printed in this manner. For PDE devices, the nodes are numbered according to the order they appear, so lead currents are referenced like I1(<device>), I2(<device>), etc. In Xyce, a .PRINT line request like I(Q1) is a parsing error for a multi-terminal device. Instead, an explicit lead current designator like IC(Q1) must be used.

- The "lead current" method of printing from devices in Xyce is done at a low level with special code added to each device; the method is therefore only supported in specific devices that have this extra code. So, if .PRINT I(Y) does not work, for a device called Y, then you will need to attach an ammeter (zero-volt voltage source) in series with that device and print the ammeter's current instead.
- Lead currents of subcircuit ports are not supported. However, access is provided via specific node names (e.g., X1:internalNodeName) or specific devices (e.g., X1:V3) inside the subcircuit.
- For STD formatted output, the values of the output variables are output as a series of columns (one for each output variable).
- When the command line option `-r <raw-file-name>` is used, all of the output is diverted to the *raw-file-name* file as a concatenation of the plots, and each plot includes all of the variables of the circuit instead of the variable list(s) given on the .PRINT lines in the netlist. Using the `-a` options in conjunction with the `-r` option results in a raw file that is output all in ASCII characters.
- Any output going to the same file from one simulation of Xyce results in the concatenation of output. However, if a simulation is re-run then the original output will be over-written.
- During analysis a number of output files may be generated. The selection of which files are created depends on a variety of factors, most obvious of which is the .PRINT command. See section 2.1 for more details.
- Frequency domain values are output as complex values for Raw, TecPlot and Probe formats when a complex variable is printed. For STD and CSV formats, the output appears in two columns, the real part followed by the imaginary part. The print variables VR, VI, VM, VDB and VP print the scalar values for the real part, imaginary part, magnitude, magnitude in decibels, and phase, respectively.
- When outputting a device or model parameter, it is usually necessary to specify both the device name and the parameter name, separated by a colon. For example, the saturation current of a diode model DMOD would be requested as DMOD:IS. Section 2.1.31.12 on "Device Parameters and Internal Variables" below gives more details and provides an example.
- The N() syntax is used to access internal solution variables that are not normally visible from the netlist, such as voltages on internal nodes and/or branch currents within a given device. The internal solution variables for each Xyce device are not given in the Reference Guide sections on those devices. However, if the user runs Xyce `-namesfile <filename> <netlist>` then Xyce will output into the first filename a list of all solution variables generated by that netlist.

Section 2.1.31.12 on “Device Parameters and Internal Variables” below gives more details and provides an example.

- The DNI() and DNO() syntax is used to print out the individual input and output noise contributions for each noise source within a device. The user can get a listing of the noise source names for each device in a netlist by running Xyce `-noise_names_file <filename> <netlist>`. The Xyce Users’ Guide [1] provides an example.
- If multiple `.PRINT` lines are given for the same analysis type, the same output file name, and the same format, the variable lists of all matching `.PRINT` lines are merged together in the order found, and the resulting output is the same as if all the print line variable lists had been specified on a single `.PRINT` line.
- Attempting to specify multiple `.PRINT` lines for the same analysis type to the same file with different specifications of `FORMAT` is an error.
- Xyce should emit a warning or error message, similar to “Could not open filename” if: 1) the name of the output file is actually a directory name; or 2) the output file is in a subdirectory that does not already exist. Xyce will not create new subdirectories.
- The output filename specified with the `-r` command line option, to produce raw file output, should take precedence over a `FILE=` parameter specified on a `.PRINT` line.
- The print statements for some analysis types could result in multiple output files. For example, `.PRINT HB` will produce both frequency- and time-domain output, and place these in different files. The default name of these files is the name of the netlist followed by a data type suffix, followed by a format-specific extension.

In Xyce, if a `FILE` option is given to such a print statement, only the “primary” data for that analysis type is sent to the named file. The secondary data is still sent to the default file name. This behavior may be subject to change in future releases.

For analysis types that can produce multiple files, special `.PRINT` lines have been provided to allow the user to control the handling of the additional files. These additional print line specifiers are enumerated in the analysis-specific sections below.

If one desires that all outputs for a given analysis type be given user-defined file names, it is necessary to use additional print lines with additional `FILE` options. For example, if one uses a `FILE` option to a `.PRINT HB` line, only frequency-domain data will be sent to the named file. To redirect the time-domain data to a file with a user-defined name, add a `.PRINT HB_TD` line. See the individual analysis types below for details of what additional print statements are available.

2.1.31.1. Print AC Analysis

AC Analysis generates two output files, the primary output is in the frequency domain and the initial conditions output is in the time domain.

Note that when using the `.PRINT AC` to create the variable list for DC type output, usage of frequency domain functions like `VDB` can result in `-Inf` output being written to the output file. This is easily solved by defining a `.PRINT AC_IC` command to specify the correct output for initial condition data.

Homotopy output can also be generated.

Table 2-19. Print AC Analysis Type

Trigger	Files	Columns/Description
<code>.PRINT AC</code>	<i>circuit-file.FD.prn</i>	INDEX FREQ
<code>.PRINT AC FORMAT=GNU PLOT</code>	<i>circuit-file.FD.prn</i>	INDEX FREQ
<code>.PRINT AC FORMAT=S PLOT</code>	<i>circuit-file.FD.prn</i>	INDEX FREQ
<code>.PRINT AC FORMAT=NOINDEX</code>	<i>circuit-file.FD.prn</i>	FREQ
<code>.PRINT AC FORMAT=CSV</code>	<i>circuit-file.FD.csv</i>	FREQ
<code>.PRINT AC FORMAT=RAW</code>	<i>circuit-file.raw</i>	FREQ
Xyce -a <code>.PRINT AC FORMAT=RAW</code>	<i>circuit-file.raw</i>	FREQ
<code>.PRINT AC FORMAT=TECPLOT</code>	<i>circuit-file.FD.dat</i>	FREQ
<code>.PRINT AC FORMAT=PROBE</code>	<i>circuit-file.csd</i>	–
<i>Add .OP To Netlist To Enable AC_IC Output</i>		
<code>.PRINT AC_IC</code>	<i>circuit-file.TD.prn</i>	INDEX TIME
<code>.PRINT AC_IC FORMAT=GNU PLOT</code>	<i>circuit-file.TD.prn</i>	INDEX TIME
<code>.PRINT AC_IC FORMAT=S PLOT</code>	<i>circuit-file.TD.prn</i>	INDEX TIME
<code>.PRINT AC_IC FORMAT=NOINDEX</code>	<i>circuit-file.TD.prn</i>	TIME
<code>.PRINT AC_IC FORMAT=CSV</code>	<i>circuit-file.TD.csv</i>	TIME
<code>.PRINT AC_IC FORMAT=RAW</code>	<i>circuit-file.raw</i>	TIME
Xyce -a <code>.PRINT AC_IC FORMAT=RAW</code>	<i>circuit-file.raw</i>	TIME
<code>.PRINT AC_IC FORMAT=TECPLOT</code>	<i>circuit-file.TD.dat</i>	TIME
<code>.PRINT AC_IC FORMAT=PROBE</code>	<i>circuit-file.TD.csd</i>	–
<i>Command Line Raw Override Output</i>		
Xyce -r raw-file-name	<i>raw-file-name</i>	All circuit variables printed
Xyce -r raw-file-name -a	<i>raw-file-name</i>	All circuit variables printed
<i>Additional Output Available</i>		
<code>.OP</code>	<i>log file</i>	Operating point data
<code>.SENS</code> <code>.PRINT SENS</code>		see Print Sensitivity

Table 2-19. Print AC Analysis Type

Trigger	Files	Columns/Description
.OPTIONS NONLIN CONTINUATION=<method> .PRINT HOMOTOPY		see Print Homotopy

2.1.31.2. Print DC Analysis

DC Analysis generates output based on the format specified by the .PRINT command.

Homotopy and sensitivity output can also be generated.

Table 2-20. Print DC Analysis Type

Trigger	Files	Columns/Description
.PRINT DC	<i>circuit-file.prn</i>	INDEX
.PRINT DC FORMAT=GNU PLOT	<i>circuit-file.prn</i>	INDEX
.PRINT DC FORMAT=S PLOT	<i>circuit-file.prn</i>	INDEX
.PRINT DC FORMAT=NOINDEX	<i>circuit-file.prn</i>	–
.PRINT DC FORMAT=CSV	<i>circuit-file.csv</i>	–
.PRINT DC FORMAT=RAW	<i>circuit-file.raw</i>	–
Xyce -a .PRINT DC FORMAT=RAW	<i>circuit-file.raw</i>	–
.PRINT DC FORMAT=TECPLOT	<i>circuit-file.dat</i>	–
.PRINT DC FORMAT=PROBE	<i>circuit-file.csd</i>	–

Command Line Raw Override Output

Xyce -r raw-file-name	<i>raw-file-name</i>	All circuit variables
Xyce -r raw-file-name -a	<i>raw-file-name</i>	All circuit variables

Additional Output Available

.OP	<i>log file</i>	Operating point data
.SENS .PRINT SENS		see Print Sensitivity
.OPTIONS NONLIN CONTINUATION=<method> .PRINT HOMOTOPY		see Print Homotopy

2.1.31.3. Print Harmonic Balance Analysis

HB Analysis generates one output file in the frequency domain and one in the time domain based on the format specified by the .PRINT command. Additional startup and initial conditions output can be generated based on .OPTIONS commands.

Note that when using the .PRINT HB to create the variable list for time domain output, usage of frequency domain functions like VDB can result in -Inf output being written to the output file. This is easily solved by

defining a .PRINT HB_TD, .PRINT HB_IC and .PRINT HB_STARTUP commands to specify the correct output for the time domain data.

If .STEP is used with HB then the Initial Condition (IC) data will initially be output to a “tmp file” (e.g., <netlist-name>.hb_ic.prn.tmp). If that IC data meets the required tolerance then it will be copied to the end of the <netlist-name>.hb_ic.prn file, and the tmp file will be deleted.

Homotopy output can also be generated.

Table 2-21. Print HB Analysis Type

Trigger	Files	Columns/Description
.PRINT HB	<i>circuit-file</i> .HB.TD.prn <i>circuit-file</i> .HB.FD.prn <i>circuit-file</i> .hb_ic.prn	INDEX TIME INDEX FREQ INDEX TIME
.PRINT HB FORMAT=GNU PLOT	<i>circuit-file</i> .HB.TD.prn <i>circuit-file</i> .HB.FD.prn <i>circuit-file</i> .hb_ic.prn	INDEX TIME INDEX FREQ INDEX TIME
.PRINT HB FORMAT=S PLOT	<i>circuit-file</i> .HB.TD.prn <i>circuit-file</i> .HB.FD.prn <i>circuit-file</i> .hb_ic.prn	INDEX TIME INDEX FREQ INDEX TIME
.PRINT HB FORMAT=NOINDEX	<i>circuit-file</i> .HB.TD.prn <i>circuit-file</i> .HB.FD.prn <i>circuit-file</i> .hb_ic.prn	TIME FREQ TIME
.PRINT HB FORMAT=CSV	<i>circuit-file</i> .HB.TD.csv <i>circuit-file</i> .HB.FD.csv <i>circuit-file</i> .hb_ic.csv	TIME FREQ TIME
.PRINT HB FORMAT=TECPLOT	<i>circuit-file</i> .HB.TD.dat <i>circuit-file</i> .HB.FD.dat <i>circuit-file</i> .hb_ic.dat	TIME FREQ TIME
.PRINT HB_FD	<i>circuit-file</i> .HB.FD.prn	INDEX FREQ
.PRINT HB_FD FORMAT=GNU PLOT	<i>circuit-file</i> .HB.FD.prn	INDEX FREQ
.PRINT HB_FD FORMAT=S PLOT	<i>circuit-file</i> .HB.FD.prn	INDEX FREQ
.PRINT HB_FD FORMAT=NOINDEX	<i>circuit-file</i> .HB.FD.prn	FREQ
.PRINT HB_FD FORMAT=CSV	<i>circuit-file</i> .HB.FD.csv	FREQ
.PRINT HB_FD FORMAT=TECPLOT	<i>circuit-file</i> .HB.FD.dat	FREQ
.PRINT HB_TD	<i>circuit-file</i> .HB.TD.prn	INDEX TIME
.PRINT HB_TD FORMAT=GNU PLOT	<i>circuit-file</i> .HB.TD.prn	INDEX TIME
.PRINT HB_TD FORMAT=S PLOT	<i>circuit-file</i> .HB.TD.prn	INDEX TIME
.PRINT HB_TD FORMAT=NOINDEX	<i>circuit-file</i> .HB.TD.prn	TIME
.PRINT HB_TD FORMAT=CSV	<i>circuit-file</i> .HB.TD.csv	TIME
.PRINT HB_TD FORMAT=TECPLOT	<i>circuit-file</i> .HB.TD.dat	TIME
Startup Period		
.OPTIONS HBINT STARTUPPERIODS=<n> .PRINT HB_STARTUP	<i>circuit-file</i> .startup.prn	INDEX TIME

Table 2-21. Print HB Analysis Type

Trigger	Files	Columns/Description
.OPTIONS HBINT STARTUPPERIODS=<n> .PRINT HB_STARTUP FORMAT=GNUPLLOT	<i>circuit-file.startup.prn</i>	INDEX TIME
.OPTIONS HBINT STARTUPPERIODS=<n> .PRINT HB_STARTUP FORMAT=SPLIT	<i>circuit-file.startup.prn</i>	INDEX TIME
.OPTIONS HBINT STARTUPPERIODS=<n> .PRINT HB_STARTUP FORMAT=NOINDEX	<i>circuit-file.startup.prn</i>	TIME
.OPTIONS HBINT STARTUPPERIODS=<n> .PRINT HB_STARTUP FORMAT=CSV .OPTIONS HBINT STARTUPPERIODS=<n>	<i>circuit-file.startup.csv</i>	TIME
.OPTIONS HBINT STARTUPPERIODS=<n> .PRINT HB_STARTUP FORMAT=TECPLOT .OPTIONS HBINT STARTUPPERIODS=<n>	<i>circuit-file.startup.dat</i>	TIME
<i>Initial Conditions</i>		
.OPTIONS HBINT SAVEICDATA=1 .PRINT HB_IC	<i>circuit-file.hb_ic.prn</i>	INDEX TIME
.OPTIONS HBINT SAVEICDATA=1 .PRINT HB_IC FORMAT=GNUPLLOT	<i>circuit-file.hb_ic.prn</i>	INDEX TIME
.OPTIONS HBINT SAVEICDATA=1 .PRINT HB_IC FORMAT=SPLIT	<i>circuit-file.hb_ic.prn</i>	INDEX TIME
.OPTIONS HBINT SAVEICDATA=1 .PRINT HB_IC FORMAT=NOINDEX	<i>circuit-file.hb_ic.prn</i>	TIME
.OPTIONS HBINT SAVEICDATA=1 .PRINT HB_IC FORMAT=CSV	<i>circuit-file.hb_ic.csv</i>	TIME
.OPTIONS HBINT SAVEICDATA=1 .PRINT HB_IC FORMAT=TECPLOT	<i>circuit-file.hb_ic.dat</i>	TIME
<i>Additional Output Available</i>		
.OP	<i>log file</i>	Operating point data
.SENS .PRINT SENS		see Print Sensitivity
.OPTIONS NONLIN CONTINUATION=<method> .PRINT HOMOTOPY		see Print Homotopy

2.1.31.4. Print Noise Analysis

NOISE Analysis generates two output files, the primary output is in the frequency domain and the initial conditions output is in the time domain.

Table 2-22. Print NOISE Analysis Type

Trigger	Files	Columns/Description
.PRINT NOISE	<i>circuit-file.NOISE.prn</i>	INDEX FREQ

Table 2-22. Print NOISE Analysis Type

Trigger	Files	Columns/Description
.PRINT NOISE FORMAT=GNUPLOT	<i>circuit-file.NOISE.prn</i>	INDEX FREQ
.PRINT NOISE FORMAT=SPLIT	<i>circuit-file.NOISE.prn</i>	INDEX FREQ
.PRINT NOISE FORMAT=NOINDEX	<i>circuit-file.NOISE.prn</i>	FREQ
.PRINT NOISE FORMAT=CSV	<i>circuit-file.NOISE.csv</i>	FREQ
.PRINT NOISE FORMAT=TECPLOT	<i>circuit-file.NOISE.dat</i>	FREQ
<i>Additional Output Available</i>		
.OP	<i>log file</i>	Operating point data
.OPTIONS NONLIN CONTINUATION=<method> .PRINT HOMOTOPY		see Print Homotopy

2.1.31.5. Print Transient Analysis

Transient Analysis generates time domain output based on the format specified by the .PRINT command.

Homotopy and sensitivity output can also be generated.

Table 2-23. Print Transient Analysis Type

Trigger	Files	Columns/Description
.PRINT TRAN	<i>circuit-file.prn</i>	INDEX TIME
.PRINT TRAN FORMAT=GNUPLOT	<i>circuit-file.prn</i>	INDEX TIME
.PRINT TRAN FORMAT=SPLIT	<i>circuit-file.prn</i>	INDEX TIME
.PRINT TRAN FORMAT=NOINDEX	<i>circuit-file.prn</i>	TIME
.PRINT TRAN FORMAT=CSV	<i>circuit-file.csv</i>	TIME
.PRINT TRAN FORMAT=RAW	<i>circuit-file.raw</i>	TIME
Xyce -a .PRINT TRAN FORMAT=RAW	<i>circuit-file.raw</i>	TIME
.PRINT TRAN FORMAT=TECPLOT	<i>circuit-file.dat</i>	TIME
.PRINT TRAN FORMAT=PROBE	<i>circuit-file.csd</i>	–
<i>Command Line Raw Override Output</i>		
Xyce -r raw-file-name	<i>raw-file-name</i>	All circuit variables printed
Xyce -r raw-file-name -a	<i>raw-file-name</i>	All circuit variables printed
<i>Additional Output Available</i>		
.OP	<i>log file</i>	Operating point data
.SENS .PRINT SENS		see Print Sensitivity
.OPTIONS NONLIN CONTINUATION=<method> .PRINT HOMOTOPY		see Print Homotopy

2.1.31.6. Print Homotopy

Homotopy output is generated by the inclusion of the
`.OPTIONS NONLIN CONTINUATION=<method>` command.

Table 2-24. Print Homotopy

Trigger	Files	Columns/Description
<code>.OPTIONS NONLIN CONTINUATION=<method></code> <code>.PRINT HOMOTOPY</code>	<i>circuit-file</i> .HOMOTOPY.prn	INDEX TIME
<code>.OPTIONS NONLIN CONTINUATION=<method></code> <code>.PRINT HOMOTOPY FORMAT=GNUPLOT</code>	<i>circuit-file</i> .HOMOTOPY.prn	INDEX TIME
<code>.OPTIONS NONLIN CONTINUATION=<method></code> <code>.PRINT HOMOTOPY FORMAT=SPLOT</code>	<i>circuit-file</i> .HOMOTOPY.prn	INDEX TIME
<code>.OPTIONS NONLIN CONTINUATION=<method></code> <code>.PRINT HOMOTOPY FORMAT=NOINDEX</code>	<i>circuit-file</i> .HOMOTOPY.prn	TIME
<code>.OPTIONS NONLIN CONTINUATION=<method></code> <code>.PRINT HOMOTOPY FORMAT=CSV</code>	<i>circuit-file</i> .HOMOTOPY.csv	TIME
<code>.OPTIONS NONLIN CONTINUATION=<method></code> <code>.PRINT HOMOTOPY FORMAT=TECPLOT</code>	<i>circuit-file</i> .HOMOTOPY.dat	TIME

2.1.31.7. Print Sensitivity

Sensitivity is enabled by inclusion of the
`.SENS` command.

Steady-state sensitivities (adjoint or direct) and transient direct sensitivities will be handled by the `.PRINT SENS` command. Transient adjoint, on the other hand, is handled by the `.PRINT TRANADJOINT` command.

For transient sensitivity output, a TIME column will be included for the STD, GNUPLOT, SPLOT, NOINDEX and CSV formats. For AC sensitivity output, a FREQ column will be included for the STD, GNUPLOT, SPLOT, NOINDEX and CSV formats.

Table 2-25. Print Sensitivities for .TRAN and .DC

Trigger	Files	Columns/Description
<code>.SENS objfunc=<obj> param=[p_1][, p_n]*</code> <code>.PRINT SENS</code>	<i>circuit-file</i> .SENS.prn	{ <i>obj</i> }, d_{ <i>obj</i> }/d_ p_1 _[dir adj], d_{ <i>obj</i> }/d_ p_n _[dir adj]
<code>.SENS objfunc=<obj> param=[p_1][, p_n]*</code> <code>.PRINT SENS FORMAT=GNUPLOT</code>	<i>circuit-file</i> .SENS.prn	{ <i>obj</i> }, d_{ <i>obj</i> }/d_ p_1 _[dir adj], d_{ <i>obj</i> }/d_ p_n _[dir adj]

Table 2-25. Print Sensitivities for .TRAN and .DC

Trigger	Files	Columns/Description
.SENS objfunc=<obj> param=[p ₁][,p _n]* .PRINT SENS FORMAT=SPLIT	circuit-file.SENS.prn	{obj}, d_{obj}/d_p1_[dir adj], d_{obj}/d_pn_[dir adj]
.SENS objfunc=<obj> param=[p ₁][,p _n]* .PRINT SENS FORMAT=NOINDEX	circuit-file.SENS.prn	{obj}, d_{obj}/d_p1_[dir adj], d_{obj}/d_pn_[dir adj]
.SENS objfunc=<obj> param=[p ₁][,p _n]* .PRINT SENS FORMAT=CSV	circuit-file.SENS.csv	{obj}, d_{obj}/d_p1_[dir adj], d_{obj}/d_pn_[dir adj]
.SENS objfunc=<obj> param=[p ₁][,p _n]* .PRINT SENS FORMAT=TECPLOT	circuit-file.SENS.dat	{obj}, d_{obj}/d_p1_[dir adj], d_{obj}/d_pn_[dir adj]

Table 2-26. Print Sensitivities for .AC

Trigger	Files	Columns/Description
.SENS [objvars acobjfunc]=<obj> + param=[p ₁][,p _n]* .PRINT SENS	circuit-file.FD.SENS.prn	{obj}, d_{obj}/d_p1_[dir adj], d_{obj}/d_pn_[dir adj]
.SENS [objvars acobjfunc]=<obj> + param=[p ₁][,p _n]* .PRINT SENS FORMAT=GNUPLT	circuit-file.FD.SENS.prn	{obj}, d_{obj}/d_p1_[dir adj], d_{obj}/d_pn_[dir adj]
.SENS [objvars acobjfunc]=<obj> + param=[p ₁][,p _n]* .PRINT SENS FORMAT=SPLIT	circuit-file.FD.SENS.prn	{obj}, d_{obj}/d_p1_[dir adj], d_{obj}/d_pn_[dir adj]
.SENS [objvars acobjfunc]=<obj> + param=[p ₁][,p _n]* .PRINT SENS FORMAT=NOINDEX	circuit-file.FD.SENS.prn	{obj}, d_{obj}/d_p1_[dir adj], d_{obj}/d_pn_[dir adj]
.SENS [objvars acobjfunc]=<obj> + param=[p ₁][,p _n]* .PRINT SENS FORMAT=CSV	circuit-file.FD.SENS.csv	{obj}, d_{obj}/d_p1_[dir adj], d_{obj}/d_pn_[dir adj]
.SENS [objvars acobjfunc]=<obj> + param=[p ₁][,p _n]* .PRINT SENS FORMAT=TECPLOT	circuit-file.FD.SENS.dat	{obj}, d_{obj}/d_p1_[dir adj], d_{obj}/d_pn_[dir adj]

Table 2-27. Print Transient Adjoint Sensitivities

Trigger	Files	Columns/Description
.SENS objfunc=<obj> param=[p ₁][, p _n]* .PRINT TRANADJOINT	circuit-file.TRADJ.prn	{obj}, d_{obj}/d_p1_adj, d_{obj}/d_pn_adj
.SENS objfunc=<obj> param=[p ₁][, p _n]* .PRINT TRANADJOINT FORMAT=NOINDEX	circuit-file.TRADJ.prn	{obj}, d_{obj}/d_p1_adj, d_{obj}/d_pn_adj
.SENS objfunc=<obj> param=[p ₁][, p _n]* .PRINT TRANADJOINT FORMAT=CSV	circuit-file.TRADJ.csv	{obj}, d_{obj}/d_p1_adj, d_{obj}/d_pn_adj
.SENS objfunc=<obj> param=[p ₁][, p _n]* .PRINT TRANADJOINT FORMAT=TECPLOT	circuit-file.TRADJ.dat	{obj}, d_{obj}/d_p1_adj, d_{obj}/d_pn_adj

2.1.31.8. Print Embedded Sampling Analysis

EMBEDDEDSAMPLING Analysis generates one output file, with the information for each output variable grouped in a set of contiguous columns, based on the format specified by the .PRINT command. The arguments OUTPUT_SAMPLE_STATS and OUTPUT_ALL_SAMPLES are specific to .PRINT ES lines. Section 2.1.5 has more details on their usage.

For a transient analysis, a TIME column will also be included for the STD, GNUPLOT, SPLOT, NOINDEX and CSV formats. The TIME variable will also be included in the TECPLOT format for that case.

Table 2-28. Print EMBEDDEDSAMPLING Analysis Type

Trigger	Files	Columns/Description
.PRINT ES	circuit-file.ES.prn	INDEX
.PRINT ES FORMAT=GNUPLOT	circuit-file.ES.prn	INDEX
.PRINT ES FORMAT=SPLOT	circuit-file.ES.prn	INDEX
.PRINT ES FORMAT=NOINDEX	circuit-file.ES.prn	–
.PRINT ES FORMAT=CSV	circuit-file.ES.csv	–
.PRINT ES FORMAT=TECPLOT	circuit-file.ES.dat	–

2.1.31.9. Print Intrusive PCE Analysis

PCE Analysis generates one output file, with the information for each output variable grouped in a set of contiguous columns, based on the format specified by the .PRINT command. The arguments OUTPUT_SAMPLE_STATS and OUTPUT_ALL_SAMPLES are specific to .PRINT PCE lines. Section 2.1.27 has more details on their usage.

For a transient analysis, a TIME column will also be included for the STD, GNUPLOT, SPLOT, NOINDEX and CSV formats. The TIME variable will also be included in the TECPLOT format for that case.

Table 2-29. Print PCE Analysis Type

Trigger	Files	Columns/Description
.PRINT PCE	<i>circuit-file.PCE.prn</i>	INDEX
.PRINT PCE FORMAT=GNUPLLOT	<i>circuit-file.PCE.prn</i>	INDEX
.PRINT PCE FORMAT=SPLIT	<i>circuit-file.PCE.prn</i>	INDEX
.PRINT PCE FORMAT=NOINDEX	<i>circuit-file.PCE.prn</i>	–
.PRINT PCE FORMAT=CSV	<i>circuit-file.PCE.csv</i>	–
.PRINT PCE FORMAT=TECPLOT	<i>circuit-file.PCE.dat</i>	–

2.1.31.10. Parameter Stepping

During parameter stepping, enabled with the .STEP command, the output generated by each of analysis types varies. Generally the FORMAT indicates this variation, however some combinations of analysis and format can result in additional variation.

The following table lists how the output differs for each analysis type and format.

Print Type	Format	Description
AC	STD	1, 3, 4, 11, 12, 13
AC	GNUPLLOT	1, 3, 4, 11, 12, 13, 20
AC	SPLIT	1, 3, 4, 11, 12, 13, 21
AC	CSV	4, 11
AC	PROBE	16
AC	TECPLOT	4, 12, 13, 18
AC	RAW	19
AC	RAW (Xyce -a)	19
AC_IC	STD	1, 4, 11, 12, 13
AC_IC	GNUPLLOT	1, 4, 11, 12, 13, 20
AC_IC	SPLIT	1, 4, 11, 12, 13, 21
AC_IC	CSV	4, 11
AC_IC	PROBE	16
AC_IC	TECPLOT	12, 13, 18
AC_IC	RAW	19
AC_IC	RAW (Xyce -a)	19
DC	STD	1, 11, 12
DC	GNUPLLOT	1, 11, 12, 20
DC	SPLIT	1, 11, 12, 21
DC	CSV	11
DC	PROBE	17
DC	TECPLOT	4, 12, 13, 18

Print Type	Format	Description
DC	RAW	19
DC	RAW (Xyce -a)	19
HB_TD	STD	1, 2, 4, 11, 12, 13
HB_TD	GNU PLOT	1, 2, 4, 11, 12, 13, 20
HB_TD	S PLOT	1, 2, 4, 11, 12, 13, 21
HB_TD	CSV	11
HB_TD	TECPLOT	12, 13, 18
HB_FD	STD	1, 3, 4, 11, 12, 13
HB_FD	GNU PLOT	1, 3, 4, 11, 12, 13, 20
HB_FD	S PLOT	1, 3, 4, 11, 12, 13, 21
HB_FD	CSV	4, 11
HB_FD	TECPLOT	4, 12, 13, 18
HB_IC	STD	1, 2, 4, 11, 12, 13
HB_IC	GNU PLOT	1, 2, 4, 11, 12, 13, 20
HB_IC	S PLOT	1, 2, 4, 11, 12, 13, 21
HB_IC	CSV	11
HB_IC	TECPLOT	12, 13, 18
HB_STARTUP	STD	1, 2, 4, 11, 12, 13
HB_STARTUP	GNU PLOT	1, 2, 4, 11, 12, 13, 20
HB_STARTUP	S PLOT	1, 2, 4, 11, 12, 13, 21
HB_STARTUP	CSV	11
HB_STARTUP	TECPLOT	12, 13, 18
TRAN	STD	1, 2, 11, 12
TRAN	GNU PLOT	1, 2, 11, 12, 20
TRAN	S PLOT	1, 2, 11, 12, 21
TRAN	CSV	2, 11
TRAN	PROBE	17
TRAN	TECPLOT	2, 4, 12, 13, 18
TRAN	RAW	2, 19
TRAN	RAW (Xyce -a)	2, 19
<i>Specialized Output Commands</i>		
HOMOTOPY	STD	1, 2, 4, 11, 15
HOMOTOPY	GNU PLOT	1, 2, 4, 11, 15, 20
HOMOTOPY	S PLOT	1, 2, 4, 11, 15, 21
HOMOTOPY	CSV	2, 11
HOMOTOPY	PROBE	17
HOMOTOPY	TECPLOT	2, 4, 15, 18

Print Type	Format	Description
SENSITIVITY	STD	1, 2, 11, 14
SENSITIVITY	GNU PLOT	1, 2, 11, 14, 20
SENSITIVITY	S PLOT	1, 2, 11, 14, 21
SENSITIVITY	CSV	2, 11
SENSITIVITY	TEC PLOT	2, 14, 18

Description	
1	INDEX column added to output variable list
2	TIME column added to output variable list
3	FREQ column added to output variable list
4	Frequency domain data written as $\text{Re}(var)$ and $\text{Im}(var)$
11	INDEX resets to zero at start of each .STEP
12	Prints 'End of Xyce(TM) Parameter Sweep' at end of .STEP simulation
13	Prints 'End of Xyce(TM) Simulation' at end of non-.STEP simulation
14	Prints 'End of Xyce(TM) Sensitivity Simulation' at end of simulation
15	Prints 'End of Xyce(TM) Homotopy Simulation' at end of simulation
16	Two '#' at the end of each .STEP (BUG)
17	One '#' at end of each .STEP
18	New ZONE for each .STEP, and AUXDATA for each .STEP parameter
19	Prints 'Plotname: Step Analysis: Step s of n params' at the start of each .STEP
20	Inserts two blank lines before the data for steps 1,2,3,... where the first step is step 0
21	Inserts one blank line before the data for steps 1,2,3,... where the first step is step 0

2.1.31.11. Print Wildcards

Wildcards are supported on .PRINT lines, as described below. In particular, $V(*)$ will print all of the node voltages in the circuit for all analysis modes. The $P(*)$ and $W(*)$ wildcards are supported for analysis modes (TRAN and DC) that support power calculations.

For TRAN and DC analysis modes, $I(*)$ will print all of the currents. This includes both solution variables, which generally means those associated with voltage sources and inductors that are not coupled through a mutual inductance device, and the lead currents associated with most other devices. For TRAN and DC, the $I(*)$ wildcard also supports lead currents for the multi-terminal J, M and Z devices via $IB(*)$,

ID(*), IG(*) and IS(*), and for the multi-terminal Q device via IB(*), IC(*), IE(*) and IS(*). The IE(*) wildcard is also supported for SOI and CMG devices. A request for I(*) will not return any of the lead currents for J, M, Q or Z devices. Wildcards of the form I1(*), that use numerical designators, are only supported for the T and YGENEXT devices. Finally, as an example, a request for IC(*) in a netlist that does not contain any Q devices will be silently ignored.

For AC and NOISE analysis modes, the I(*) operator will only output the branch currents, since lead currents are not supported for those two analysis modes. The VR(*), VI(*), VP(*), VM(*), VDB(*), IR(*), II(*), IP(*), IM(*) and IDB(*) wildcards are also supported for these two analysis modes.

There is also support for the * character (meaning “zero or more characters”) and the ? character (meaning “any one character”) in more complex wildcards, where the * and/or ? characters can be in any positions in the wildcard specification. For example, V(X1*) will output the voltage at all nodes in subcircuit X1 for all analysis modes. As another example, V(1?) will output the voltage at all nodes that have two-character names that start with the character 1. These more complex wildcards should work for all supported voltage operators.

Similarly, P(X1*) or W(X1*) will output the power for all devices, that support power calculations, in subcircuit X1. Devices that don’t support power calculations will be silently omitted. Alternately, P(R?) or W(R?) will output the power for all resistors that have two-character names.

More complex wildcards are also supported for all valid current operators. The caveats are that for DC and TRAN analyses, the wildcard will include both branch and lead currents. For AC and NOISE analyses, the wildcard will only include branch currents.

2.1.31.12. Device Parameters and Internal Variables

This subsection describes how to print out device parameters and device internal variables, via a simple V-R circuit example. In particular, the example given below gives illustrative examples of how to print out the voltage at a node (V(1)), the current through a device (I(V1)), the current through a device using using an internal solution variable (N(V1_branch)), a device parameter (R1:R) and the power dissipated by a device (P(R1)). It also shows how device parameters and internal variables can be used in a Xyce expression.

```
* filename is example.cir
.DC V1 1 2 1
V1 1 0 1
R1 1 0 2
.PRINT DC FORMAT=NOINDEX PRECISION=2 WIDTH=8
+ V(1) I(V1) N(V1_branch) R1:R P(R1) {R1:R*N(V1_branch)*I(V1)}
.END
```

The Xyce output would then be (where the NOFORMAT, WIDTH and PRECISION arguments were used mainly to format the example output for this guide):

V(1)	I(V1)	N(V1_BRANCH)	R1:R	P(R1)	{R1:R*N(V1_BRANCH)*I(V1)}
1.00e+00	-5.00e-01	-5.00e-01	2.00e+00	5.00e-01	5.00e-01
2.00e+00	-1.00e+00	-1.00e+00	2.00e+00	2.00e+00	2.00e+00

The internal solution variables for each Xyce device are typically not given in the Reference Guide sections on those devices. However, if for the example given above, the user runs `Xyce -namesfile example_names example.cir` then the file `example_names` would contain a list of the two solution variables that are accessible with the `N()` syntax on a `.PRINT` line. In this simple example, they are the voltage at Node 1 and the branch current through the voltage source V1. If V1 was in a subcircuit then the `example_names` file would have shown the “fully-qualified” device name, including the subcircuit names.

HEADER

```
0    v1_branch
1          1
```

Additional (and more useful) examples for using the `N()` syntax to print out:

- The M , R , B and H internal variables for mutual inductors are given in Section 2.3.6. This includes an example where the mutual inductor is in a sub-circuit.
- The g_m (transconductance), V_{th} , V_{ds} , V_{gs} , V_{bs} , and V_{dsat} internal variables for the BSIM3 and BSIM4 models for the MOSFET are given in Section 2.3.20.

In these two cases, only the M and R variables for the mutual inductors are actually solution variables. However, the `-namesfile` approach can still be used to determine the fully-qualified Xyce device names required to use the `N()` syntax.

2.1.32. **.RESULT (Print results)**

Outputs the value of user-specified expressions at the end of a simulation.

General Form `.RESULT {output variable}`

Examples `.RESULT {V(a)}`
 `.RESULT {V(a)+V(b)}`

Comments The `.RESULT` line must use an expression. The line `.RESULT V(a)` will result in a parse error.

 Each `.RESULT` line must have only one expression. Multiple `.RESULT` lines can be used though to output multiple columns in the output `.res` file.

 Xyce will not produce output for `.RESULT` statements if there are no `.STEP` statements in the netlist.

2.1.32.1. **Example Netlist**

`.RESULT` lines can be combined with `.STEP` lines to output the ending values of multiple simulation runs in one `.res` file, as shown in the following usage example. The resultant `.res` file will have four lines that give the final values of the expressions `{v(b)}` and `{v(b)*v(b)/2}` at `time=0.75` seconds for all four requested combinations of `R2` and `v_amplitude`.

Simple Example of `.RESULT` capability with `.STEP`

```
R1 a b 10.0
R2 b 0 2.0
```

```
.GLOBAL_PARAM v_amplitude=2.0
Va a 0 sin (5.0 {v_amplitude} 1.0 0.0 0.0)
```

```
.PRINT TRAN v(b) {v(b)*v(b)/2}
.TRAN 0 0.75
```

```
.STEP R2 1.0 2.0 1.0
.STEP v_amplitude 1.0 2.0 1.0
```

```
.RESULT {v(b)}
.RESULT {v(b)*v(b)/2}
```

```
.END
```

2.1.33. `.SAMPLING` (Sampling UQ Analysis)

Calculates a full analysis (`.DC`, `.TRAN`, `.AC`, etc.) over a distribution of parameter values. Sampling operates similarly to `.STEP`, except that the parameter values are generated from random distributions rather than sweeps. If used in conjunction with projection-based PCE methods, then the sample points are not based on random samples. Instead they are based on the quadrature points.

General Form

```
.SAMPLING
+ param=<parameter name>,[parameter name]*
+ type=<parameter type>,[parameter type]*
+ means=<mean>,[mean]*
+ std_deviations=<standard deviation>,[standard deviation]*
```

Examples

```
.SAMPLING
+ param=R1
+ type=normal
+ means=3K
+ std_deviations=1K

.SAMPLING
+ param=R1,R2
+ type=uniform,uniform
+ lower_bounds=1K,2K
+ upper_bounds=5K,6K

.SAMPLING
+ useExpr=true

.options SAMPLES numsamples=10000

.options SAMPLES numsamples=25000
+ OUTPUTS={R1:R},{V(1)}
+ SAMPLE_TYPE=MC

.options SAMPLES numsamples=1000
+ MEASURES=maxSine
+ SAMPLE_TYPE=LHS

.options samples numsamples=30
+ covmatrix=1e6,1.0e-3,1.0e-3,4e-14
+ OUTPUTS={V(1)},{R1:R},{C1:C}
```

Arguments and

Options

`param`

Names of the parameters to be sampled. This may be any of the parameters that are valid for `.STEP`, including device instance, device model, or global

parameters. If more than one parameter, then specify as a comma-separated list.

type
Distribution type for each parameter. This may be uniform or normal. If more than one parameter, then specify as a comma-separated list.

means
If using normal distributions, the mean for each parameter must be specified. If more than one parameter, then specify as a comma-separated list.

std_deviations
If using normal distributions, the standard deviation for each parameter must be specified. If more than one parameter, then specify as a comma-separated list.

lower_bounds
If using uniform distributions, the lower bound must be specified. This is optional for normal distributions. If used with normal distributions, may alter the mean and standard deviation. If more than one parameter, then specify as a comma-separated list.

upper_bounds
If using uniform distributions, the upper bound must be specified. This is optional for normal distributions. If used with normal distributions, may alter the mean and standard deviation. If more than one parameter, then specify as a comma-separated list.

useExpr
If this argument is set to true, then the sampling algorithm will set up random inputs from expression operators such as AGAUSS and AUNIF. In this case it will also ignore the list of parameters on the .SAMPLING command line. For a complete description of expression-based random operators, see the expression documentation in section 2.2.

Comments

In addition to the .SAMPLING command, this analysis requires a .options SAMPLES command as well. The .SAMPLING command specifies parameters and their attributes, either using the useExpr option, or with comma-separated lists. The .options SAMPLES command specifies analysis options, including the number of samples, the type of sampling (LHS or MC) and the outputs and/or measures for which to compute statistics. This line also allows one to specify a non-intrusive Polynomial Chaos Expansion (PCE) method (either regression or projection PCE). To see the details of the .options SAMPLES command, see table 2-10.

On the .SAMPLING command line, if not using useExpr, parameters and their attributes must be specified using comma-separated lists. The comma-separated lists must all be the same length.

2.1.34. **.SAVE (Save operating point conditions)**

Stores the operating point of a circuit in the specified file for use in subsequent simulations. The data may be saved as .IC or .NODESET lines.

General Form .SAVE [TYPE=<IC|NODESET>] [FILE=<filename>] [LEVEL=<all|none>]
 + [TIME=<save_time>]

Examples .SAVE TYPE=IC FILE=mycircuit.ic
 .SAVE TYPE=NODESET FILE=myothercircuit.ic

 .include mycircuit.ic

Comments The file created by .SAVE will contain .IC or .NODESET lines containing all the voltage node values at the DC operating point of the circuit. The default **TYPE** is NODESET. The default filename is *netlist.cir.ic*.

 The resulting file may be used in subsequent simulations to obtain quick DC convergence simply by including it in the netlist, as in the third example line above. Xyce has no corresponding .LOAD statement.

 The **LEVEL** parameter is included for compatibility with HSPICE netlists. If **none** is specified, then no save file is created. The default **LEVEL** is **all**.

TIME is also an HSPICE compatibility parameter. This is unsupported in Xyce. Xyce outputs the save file only at time=0.0.

2.1.35. *.SENS (Compute DC, AC or transient sensitivities)*

Computes sensitivities for a user-specified objective function with respect to a user-specified list of circuit parameters.

General Form `.SENS objfunc=<output expression(s)> param=<circuit parameter(s)>`

Examples

```
.SENS objfunc={0.5*(V(B)-3.0)**2.0} param=R1:R,R2:R
.options SENSITIVITY direct=1 adjoint=1

.SENS objfunc={I(VM)},{V(3)*V(3)} param= Q2N2222:bf

.param RES=1k
.SENS objfunc={RES*V(3)*V(3)} param=C1:C

.param res=2
.func powerTestFunc(I) {res*I*I}
.SENS objfunc={powerTestFunc(I(V1))} param=R1:R

.global_param res=2
.SENS objfunc={res*I(V1)} param=R1:R

.global_param res=3.0k
.SENS objfunc={res*I(V1)} param=res

* AC example using objvars
.sens objvars=2,3 param=r1:r,c1:c,v1:acmag

* AC example using acobjfunc
.sens acobjfunc={2.0*V(2)},{I(VM)} param=r1:r,c1:c
```

Comments This capability can be applied to either DC, transient or AC analysis. Both direct and adjoint sensitivities are supported. The user can optionally request either direct or adjoint sensitivities, or both.

Although Xyce will allow the user to specify both direct and adjoint, one would generally not choose to do both. The best choice of sensitivity method depends on the problem. For problems with a small number of parameters, and (possibly) lots of objective functions, then the direct method is a more efficient choice. For problems with large numbers of parameters, but a small number of objective functions, the adjoint method is more efficient.

For all variants of sensitivity analysis, it is necessary to specify circuit parameters on the `.SENS` line in a comma-separated list. Unlike the SPICE version, this capability will not automatically use every parameter in the circuit. It is also necessary for all variations of sensitivity analysis to specify at least one objective function. This capability will not assume any particular objective function. Also, it is possible to specify multiple objective functions, in a comma-separated list.

As noted, for transient analysis, both types of sensitivities are supported. Direct sensitivities are computed at each time step during the forward calculation. Transient adjoint sensitivities, in contrast, must be computed using a reverse time integration method. The reverse time integration must be performed after the original forward calculation is complete. As such, transient adjoint sensitivity calculations can be thought of as a post-processing step. One consequence of this is that transient adjoint output must be specified using the `.PRINT TRANADJOINT` type, rather than the `.PRINT SENS` type.

If transient adjoints are specified, the default behavior for the capability is for a transient sensitivity calculation be performed for each time step, even if the forward transient simulation consists of millions of steps. For adjoint calculations, this can be problematic, as adjoint methods (noted above) are not very efficient when applied to problems with a large number of objective functions. Each time step, from the point of view of transient adjoints, is effectively a separate objective function. As such, this isn't the best use of adjoints. One can specify a list of time points for which to compute transient adjoint sensitivities. For many practical problems, the sensitivities at only one or a handful of points is needed, so this is a good way to mitigate the computational cost of adjoints. The Xyce Users' Guide [1] provides an example.

If performing a sensitivity calculation with AC analysis, there are two options for the specification of the objective function. These options are both different from the DC and TRAN method. Instead of specifying objective functions with the parameter `objfunc`, one should either use `objvars` or `acobjfunc`. The parameter `objvars` should be followed by a comma separated list of voltage nodes. The parameter `acobjfunc` should be followed by a comma separated list of objective functions. It is also possible to use both specifications in the same netlist.

2.1.36. *.STEP (Step Parametric Analysis)*

Calculates a full analysis (.DC, .TRAN, .AC, etc.) over a range of parameter values. This type of analysis is very similar to .DC analysis. Similar to .DC analysis, .STEP supports sweeps which are linear, decade logarithmic, octave logarithmic, a list of values, or over a multivariate data table.

LIN Linear sweep

The sweep variable is swept linearly from the starting to the ending value.

OCT Sweep by octaves

The sweep variable is swept logarithmically by octaves.

DEC Sweep by decades

The sweep variable is swept logarithmically by decades.

LIST Sweep over specified values

The sweep variable is swept over an enumerated list of values.

DATA Sweep over table of multivariate values

The sweep variables are swept over the rows of a table.

2.1.36.1. Linear Sweeps

General Form .STEP [LIN] <parameter name> <initial> <final> <step>

Examples

```
.STEP R1 45 50 5
.STEP V1 20 10 -1
.STEP LIN V1 20 10 -1
.STEP TEMP -45 -55 -10
.STEP C101:C 45 50 5
.STEP DLEAK:IS 1.0e-12 1.0e-11 1.0e-12
```

```
.global_param v1_val=10
V1 1 0 DC {v1_val}
.STEP v1_val 20 10 -1
```

```
.param v2_val=10
V2 2 0 DC {v2_val}
.STEP v2_val 20 10 -1
```

```
.data table
+ c1 r1
+ 1e-8 1k
+ 2e-8 0.5k
+ 3e-8 0.25k
.enddata
.STEP data=table
```

Arguments and Options**parameter name**

Name of the parameter to be swept. This may be the special parameter name TEMP (the ambient simulation temperature), a device name, device instance or model parameter name, or global parameter name as defined in a .global_param or globally-scoped .param statement.

If a device name is given, the primary parameter for that device is taken as the parameter; in the first two examples above, the primary parameters of the devices R1 and V1 are stepped (resistance and DC voltage, respectively).

The C, L and I devices are then the other devices with primary parameters, which are the capacitance, inductance and DC current, respectively.

To specify a device instance parameter other than the device's primary parameter, or if the device has no primary parameter, use the syntax <device name>:<parameter name>, as in the fourth example above.

To sweep a device model parameter, use the syntax <model name>:<parameter name>, as in the fifth example above.

initial

Initial value for the parameter.

final

Final value for the parameter.

step

Value that the parameter is incremented at each step.

Comments

For linear sweeps, the LIN keyword is optional.

STEP parameter analysis will sweep a parameter from its initial value to its final value, at increments of the step size. At each step of this sweep, it will conduct a full analysis (.DC, .TRAN, .AC, etc.) of the circuit.

The specification is similar to that of a .DC sweep, except that unlike .DC, only one parameter may be swept on each .STEP line. Multiple .STEP lines may be specified, forming nested step loops. The variables will be stepped in order such that the first .STEP line that appears in the netlist will be the innermost loop, and the last .STEP line will be the outermost.

Output, as designated by a .PRINT statement, is slightly more complicated in the case of a .STEP simulation. If the user has specified a .PRINT line in the input file, Xyce will output two files. All steps of the sweep will be output to a single file as usual, but with the results of each step appearing one after another with the "Index" column starting over at zero. Additionally, a file with a ".res" suffix will be produced indicating what parameters were used for each iteration of the step loops; this file will always be in columnar text format, irrespective of any FORMAT= option specified on .PRINT lines. If .RESULT lines (see section 2.1.32) appear in the netlist, the ".res" file will also contain columns for each expression given on the .RESULT lines, and the value of the result expression will be printed for each step taken.

Note that analysis lines in Xyce do not currently support use of expressions to define their parameters (e.g., end times for .TRAN analysis, or fundamental frequencies for .HB analysis), and so it is not possible to use stepped parameters to vary how the analysis will be run at each step. If each step requires different analysis parameters, this would have to be accomplished by performing separate runs of Xyce.

If the stop value is smaller than the start value, the step value should be negative. If a positive step value is given in this case, only a single point (at the start value) will be performed, and a warning will be emitted.

2.1.36.2. Decade Sweeps

General Form `.STEP DEC <sweep variable name> <start> <stop> <points>`

Examples `.STEP DEC VIN 1 100 2`
 `.STEP DEC R1 100 10000 3`
 `.STEP DEC TEMP 1.0 10.0 3`

Comments The stop value should be larger than the start value. If a stop value smaller than the start value is given, only a single point at the start value will be performed, and a warning will be emitted. The points value must be an integer.

2.1.36.3. Octave Sweeps

General Form `.STEP OCT <sweep variable name> <start> <stop> <points>`

Examples `.STEP OCT VIN 0.125 64 2`
 `.STEP OCT TEMP 0.125 16.0 2`
 `.STEP OCT R1 0.015625 512 3`

Comments The stop value should be larger than the start value. If a stop value smaller than the start value is given, only a single point at the start value will be performed, and a warning will be emitted. The points value must be an integer.

2.1.36.4. List Sweeps

General Form `.STEP <sweep variable name> LIST <val> <val> <val>...`

Examples `.STEP VIN LIST 1.0 2.0 10. 12.0`
 `.STEP TEMP LIST 8.0 21.0`

2.1.36.5. Data Sweeps

General Form .STEP DATA=<data table name>

Examples .STEP data=resistorValues
 .data resistorValues
 + r1 r2
 + 8.0000e+00 4.0000e+00
 + 9.0000e+00 4.0000e+00
 .enddata

2.1.37. `.SUBCKT` (*Subcircuit*)

The `.SUBCKT` statement begins a subcircuit definition by giving its name, the number and order of its nodes and the names and default parameters that direct its behavior. The `.ENDS` statement signifies the end of the subcircuit definition. See Section 2.3.33 for more information on using subcircuits with the X device.

General Form

```
.SUBCKT <name> [node]*  
+ [PARAMS:] [<name>=<value>]*  
...  
.ENDS
```

Examples

```
.SUBCKT OPAMP 10 12 111 112 13  
...  
.ENDS  
  
.SUBCKT FILTER1 INPUT OUTPUT PARAMS: CENTER=200kHz,  
+ BANDWIDTH=20kHz  
...  
.ENDS  
  
.SUBCKT PLRD IN1 IN2 IN3 OUT1  
+ PARAMS: MNTYMXDELY=0 IO_LEVEL=1  
...  
.ENDS  
  
.SUBCKT 74LS01 A B Y  
+ PARAMS: MNTYMXDELY=0 IO_LEVEL=1  
...  
.ENDS
```

Arguments and Options

name

The name used to reference a subcircuit.

node

An optional list of nodes. This is not mandatory since it is feasible to define a subcircuit without any interface nodes.

PARAMS:

Optional keyword that precedes the list of subcircuit parameters. Parameters specified on the subcircuit instance line are treated as being local to individual subcircuit instances. They can be used inside a subcircuit in the same manner as a `.param` inside the subcircuit definition. Parameters defined on the instance line override identically named parameters in the subcircuit definition.

Comments

A subcircuit designation ends with a `.ENDS` command. The entire netlist between `.SUBCKT` and `.ENDS` is part of the definition. Each time the subcircuit is called via an `X` device, the entire netlist in the subcircuit definition replaces the `X` device.

There must be an equal number of nodes in the subcircuit call and in its definition. As soon as the subcircuit is called, the actual nodes (those in the calling statement) substitute for the argument nodes (those in the defining statement).

Node zero cannot be used in this node list, as it is the global ground node.

Subcircuit references may be nested to any level. Subcircuits definitions may also be nested; a `.SUBCKT` statement and its closing `.ENDS` may appear between another `.SUBCKT/.ENDS` pair. A subcircuit defined inside another subcircuit definition is local to the outer subcircuit and may not be used at higher levels of the circuit netlist.

Subcircuits should include only device instantiations and possibly these statements:

- `.MODEL` (model definition)
- `.PARAM` (parameter)
- `.FUNC` (function)

Models, parameters, and functions defined within a subcircuit are scoped to that definition. That is they are only accessible within the subcircuit definition in which they are included. Further, if a `.MODEL`, `.PARAM` or a `.FUNC` statement is included in the main circuit netlist, it is accessible from the main circuit as well as all subcircuits.

Node, device, and model names are scoped to the subcircuit in which they are defined. It is allowable to use a name in a subcircuit that has been previously used in the main circuit netlist. When the subcircuit is flattened (expanded into the main netlist), all of its names are given a prefix via the subcircuit instance name. For example, `Q17` becomes `X3:Q17` after expansion. After expansion, all names are unique. The single exception occurs in the use of global node names, which are not expanded.

Additional illustrative examples of scoping are given in the “Working with Subcircuits and Models” section of the Xyce Users’ Guide [1]. Those examples apply to models and functions also.

2.1.38. `.TRAN` (Transient Analysis)

Calculates the time-domain response of a circuit for a specified duration.

General Form `.TRAN <initial step value> <final time value>`
 `+ [<start time value> [<step ceiling value>]] [NOOP] [UIC]`
 `+ [{schedule(<time>, <maximum time step>, ...)}]`

Examples `.TRAN 1us 100ms`
 `.TRAN 1ms 100ms 0ms .1ms`
 `.TRAN 0 2.0e-3 {schedule(0.5e-3, 0, 1.0e-3, 1.0e-6, 2.0e-3, 0)}`

 `.param initialStep=1ms, tstop=100ms, tstart=0ms, dtmax=0.1ms`
 `.TRAN {initialStep} {tstop} {tstart} {dtmax}`

Arguments and Options

`initial step value`

Used to calculate the initial time step (see below).

`final time value`

Sets the end time (duration) for the analysis.

`start time value`

Sets the time at which output of the simulation results is to begin. Defaults to zero.

`step ceiling value`

Sets a maximum time step. Defaults to ((final time value)-(start time value))/10, unless there are breakpoints (see below).

`NOOP` or `UIC`

These two options are synonyms which specify that no operating point calculation is to be performed, and that the specified initial condition (from `.IC` lines or capacitor “IC” parameters) should be used as the transient initial condition instead. Unspecified values are set to zero. Finally, the `.IC` capability can only set voltage values, not current values.

`schedule(<time>, <maximum time step>, ...)`

Specifies a schedule for maximum allowed time steps. The list of arguments, $t_0, \Delta t_0, t_1, \Delta t_1$, etc. implies that a maximum time step of Δt_0 will be used while the simulation time is greater than or equal to t_0 and less than t_1 . A maximum time step of Δt_1 will be used when the simulation time is greater than or equal to t_1 and less than t_2 . This sequence will continue for all pairs of $t_i, \Delta t_i$ that are given in the `{schedule()}`. If Δt is zero or negative, then no maximum time step is enforced (other than hardware limits of the host computer).

Comments

The transient analysis calculates the circuit's response over an interval of time beginning with `TIME=0` and finishing at `<final time value>`. Use a `.PRINT (print)` statement to get the results of the transient analysis.

Before calculating the transient response Xyce computes a bias point for the circuit that is different from the regular bias point. This is necessary because at the start of a transient analysis, the independent sources can have different values than their DC values. Specifying `NOOP` on the `.TRAN` line causes Xyce to begin the transient analysis without performing the usual bias point calculation.

The time integration algorithms within Xyce use adaptive time-stepping methods that adjust the time-step size according to the activity in the analysis. The default ceiling for the internal time step is $(\text{<final time value>} - \text{<start time value>}) / 10$. This default ceiling value is automatically adjusted if breakpoints are present, to ensure that there are always at least 10 time steps between breakpoints. If the user specifies a ceiling value, however, it overrides any internally generated ceiling values.

Xyce is not strictly compatible with SPICE in its use of the values on the `.TRAN` line. In SPICE, the first number on the `.TRAN` line specifies the printing interval. In Xyce, the first number is the `<initial step value>`, which is used in determining the initial step size. The actual initial step size is chosen to be the smallest of three quantities: the `<initial step value>`, the `<step ceiling value>`, or 1/200th of the time until the next breakpoint.

The third argument to `.TRAN` simply determines the earliest time for which results are to be output. Simulation of the circuit always begins at `TIME=0` irrespective of the setting of `<start time value>`.

2.1.39. *Miscellaneous Commands*

2.1.39.1. * (Comment)

A netlist comment line. Whitespace at the beginning of a line is also interpreted as a comment unless it is followed by a + symbol, in which case it treats the line as a continuation.

2.1.39.2. ; (In-line Comment)

Add a netlist in-line comment.

2.1.39.3. + (Line Continuation)

Continue the text of the previous line.

2.2. Expressions

Xyce supports use of mathematical expressions in several contexts:

- for the values of device instance and model parameters.
- in definition of parameters in `.PARAM` and `.GLOBAL_PARAM` statements.
- for output on `.PRINT` lines.

In all contexts where expressions are allowed, it is best practice to enclose them in curly braces (`{}`). For netlist compatibility with other simulators, expressions may be enclosed in single quotation marks instead (`'`). Also, in some circumstances (such as `.param` and `.global_param` expressions), Xyce will accept expressions that are not surrounded by either braces or single quotes. However, it is recommended that the braces be used in netlists written specifically for Xyce, as this will be the most reliable option.

The expression package in Xyce supports all standard arithmetic operators, trigonometric functions, a collection of arithmetic functions, and some functions to mimic the pulse, sine, exp, and sffm time-dependent functions in the independent current and voltage sources. These functions are listed in tables 2-33 and 2-34.

Operators

Table 2-32. Operators

Class of Operator	Operator	Meaning
arithmetic	+	addition or string concatenation
	-	subtraction
	*	multiplication
	/	division
	**	exponentiation
	%	modulus
logical ¹	~	unary NOT
		boolean OR
	^	boolean XOR
	&	boolean AND
relational	==	equality
	!=	non-equality
	>	greater-than
	>=	greater-than or equal
	<	less-than
	<=	less-than or equal
conditional	? :	Ternary conditional operator

¹Logical and relational operators are used only with the `IF()` function and the ternary operator for its conditional argument.

Special note on ternary operator Note that the ternary operator is available for use in Xyce. This operator is the same as the ternary conditional operator in C, C++, Perl, and others. The ternary expression $t?a : b$ is equivalent to the function $IF(t, a, b)$ described below. However, please be aware that the ternary operator has extremely low precedence just as it has in these other languages, and if parentheses are not used to make explicit which expressions are supposed to be part of the condition or true and false values, the resolution of the expression may be surprising.

For example, the expression

```
1+a==b?1:0+1
```

is equivalent to the expression

```
IF(1+a==b, 1, 0+1)
```

because the “+” and “==” operators have higher precedence than either “?” or “:”. Similarly:

```
A==B?1:0 + A==C?2:0 + A==D?3:0
```

is equivalent to

```
if(A==B, 1, IF(0 + A==C, 2, IF(0 + A==D, 3, 0)))
```

Given the way the original expression is written, it appears that the intent was that the expression be evaluated as:

```
If(A==B, 1, 0) + IF(A==C, 2, 0) + IF(A==D, 3, 0)
```

This is not how the expression will be evaluated. Fortunately, because of the use of “0” to the right of the colons in each case, the expression just happens to give the desired result in either interpretation, but Xyce is using the nested IF equivalent.

Finally, due to restrictions on the expression parser, **it is essential that ternary operators never be written so that a bare parameter is directly to the left of a colon**. This is because colons are actually legal characters in parameters — the colon represents hierarchy, so that $R1:R$ means the R parameter of device $R1$, and $X1:A$ refers to the node A of subcircuit $X1$. Therefore, it is necessary to put at least one character that is invalid in parameter names in between the colon and the parameter. It is sufficient to use a space.

```
{(A==B)?C:D} ; this expression will generate a syntax error
{(A==B)?C :D} ; this expression is acceptable
{(A==B)?C+0:D} ; this expression is acceptable
{(A==B)?(C):D} ; this expression is acceptable
```

Note that if using expressions without curly braces or single quotes (something that is allowed on `.param` and `.global_param` lines) this becomes even more restrictive because the parser eats up whitespace. In this case, the expression needs to be fixed another way, such as with parenthesis.

```
(A==B)?C:D ; this expression will generate a syntax error
(A==B)?C :D ; parser eliminates whitespace, causing syntax error
(A==B)?C+0:D ; this expression is acceptable
(A==B)?(C):D ; this expression is acceptable
```

Arithmetic Functions

Table 2-33. Arithmetic Functions

Function	Meaning	Explanation
<i>Arithmetic functions</i>		
ABS(x)	$ x $	absolute value of x
CEIL(x)	$\lceil x \rceil$	least integer greater or equal to variable x
DDT(x)	$\frac{d}{dt}x(t)$	time derivative of x
DDX(f(x),x)	$\frac{\partial}{\partial x}f(x)$	partial derivative of $f(x)$ with respect to x
FLOOR(x)	$\lfloor x \rfloor$	greatest integer less than or equal to variable x
FMOD(x,y)		returns the remainder of x/y as a real number
IF(t,x,y)	x if t is true, y otherwise	t is an expression using the relational operators in Table 2-32. ²
INT(x)	$\text{sgn}(x)\lfloor x \rfloor$	integer part of the real variable x
LIMIT(x,y,z)	y if $x < y$ x if $y < x < z$ z if $x > z$	x limited to range y to z Note: The two-argument version of limit, documented below, is a random operator.
M(x)	$ x $	absolute value or magnitude of x
MIN(x,y)	$\min(x, y)$	minimum of x and y
MAX(x,y)	$\max(x, y)$	maximum of x and y
NINT(x)		rounds x up or down, to the nearest integer
PWR(x,y)	x^y	x raised to y power
POW(x,y)	x^y	x raised to y power
PWRS(x,y)	x^y if $x > 0$ 0 if $x = 0$ $-(-x)^y$ if $x < 0$	sign corrected x raised to y power
SDT(x)	$\int x(t)dt$	time integral of x
SGN(x)	+1 if $x > 0$ 0 if $x = 0$ -1 if $x < 0$	sign value of x
SIGN(x,y)	$\text{sgn}(y) x $	sign of y times absolute value of x
STP(x)	1 if $x > 0$ 0 otherwise	step function

Table 2-33. Arithmetic Functions

Function	Meaning	Explanation
SQRT(x)	\sqrt{x}	square root of x
URAMP(x)	x if $x > 0$ 0 otherwise	ramp function
<i>Operators related to interpolating tabular data</i>		
TABLE(x,y,z,*)	$f(x)$ where $f(y) = z$	piecewise linear interpolation, multiple (y,z) pairs can be specified
TABLE("filename", [N], [log])		Alternate specification for TABLE, in which data is read in from a file. <code>filename</code> consists of x, y data pairs, one pair per line, space separated. Synonymous with TABLEFILE. Arguments N and log are optional, and related to sparsification. ³
FASTTABLE(x,y,z,*)	$f(x)$ where $f(y) = z$	piecewise linear interpolation without breakpoints, multiple (y,z) pairs can be specified
FASTTABLE("filename", [N], [log])		Alternate specification for FASTTABLE, in which data is read in from a file. <code>filename</code> consists of x, y data pairs, one pair per line, space separated. Arguments N and log are optional, and related to sparsification. ³
SPLINE(x,y,z,*)		Akima spline interpolation, multiple (y,z) pairs should be specified
SPLINE("filename", N)		Alternate specification for SPLINE, in which data is read in from a file. <code>filename</code> consists of x, y data pairs, one pair per line, space separated. Arguments N and log are optional, and related to sparsification. ³
AKIMA(x,y,z,*)		Akima spline interpolation [8], multiple (y,z) pairs should be specified Synonymous with SPLINE.
AKIMA("filename", [N], [log])		Alternate specification for AKIMA, in which data is read in from a file. <code>filename</code> consists of x, y data pairs, one pair per line, space separated. Arguments N and log are optional, and related to sparsification. ³
CUBIC(x,y,z,*)		Cubic spline interpolation, multiple (y,z) pairs should be specified

Table 2-33. Arithmetic Functions

Function	Meaning	Explanation
CUBIC("filename", [N], [log])		Alternate specification for CUBIC, in which data is read in from a file. <code>filename</code> consists of x, y data pairs, one pair per line, space separated. Arguments N and log are optional, and related to sparsification. ³
WODICKA($x, y, z, *$)		Wodicka spline interpolation [9], multiple (y, z) should be specified
WODICKA("filename", [N], [log])		Alternate specification for WODICKA, in which data is read in from a file. <code>filename</code> consists of x, y data pairs, one pair per line, space separated. Arguments N and log are optional, and related to sparsification. ³
BLI($x, y, z, *$)		Barycentric Lagrange interpolation [10], multiple (y, z) pairs should be specified
BLI("filename", [N], [log])		Alternate specification for BLI, in which data is read in from a file. <code>filename</code> consists of x, y data pairs, one pair per line, space separated. Arguments N and log are optional, and related to sparsification. ³
TABLEFILE("filename", [N], [log])		Alternate specification for TABLE, in which data is read in from a file. <code>filename</code> consists of x, y data pairs, one pair per line, space separated. Arguments N and log are optional, and related to sparsification. ³
<i>Operators related to complex numbers</i>		
DB (x)		output the magnitude of x in decibels
IMG(x)		imaginary part of variable x
PH(x)		phase of variable x
R(x)		real part of variable x
RE(x)		real part of variable x
M(x)	$ x $	absolute value or magnitude of x
<i>Exponential, logarithmic, and trigonometric functions</i>		
ACOS(x)	$\arccos(x)$	result in radians
ACOSH(x)	$\cosh^{-1}(x)$	hyperbolic arccosine of x
ARCTAN(x)	$\arctan(x)$	result in radians
ASIN(x)	$\arcsin(x)$	result in radians
ASINH(x)	$\sinh^{-1}(x)$	hyperbolic arcsine of x

Table 2-33. Arithmetic Functions

Function	Meaning	Explanation
ATAN(x)	$\arctan(x)$	result in radians
ATANH(x)	$\tanh^{-1}(x)$	hyperbolic arctangent of x
ATAN2(x,y)	$\arctan(x/y)$	result in radians
COS(x)	$\cos(x)$	x in radians
COSH(x)	$\cosh(x)$	hyperbolic cosine of x
EXP(x)	e^x	e to the x power
LN(x)	$\ln(x)$	log base e
LOG(x)	$\log(x)$	log base 10
LOG10(x)	$\log(x)$	log base 10
SIN(x)	$\sin(x)$	x in radians
SINH(x)	$\sinh(x)$	hyperbolic sine of x
TAN(x)	$\tan(x)$	x in radians
TANH(x)	$\tanh(x)$	hyperbolic tangent of x
<i>Operators related to random distributions</i>		
AGAUSS(μ,α,n)		Random number sampled from normal distribution with mean μ and standard deviation α/n A deviation α will be n standard deviations from the mean. The argument n is optional, and defaults to 1. ¹
GAUSS(μ,α,n)		Random number sampled from normal distribution with mean μ and standard deviation $(\alpha * \mu)/n$ A deviation $\alpha * \mu$ will be n standard deviations from the mean. The argument n is optional, and defaults to 1. ¹
AUNIF(μ,α)		Random number sampled from uniform distribution with mean μ and standard deviation α/n The number returned will differ from the mean by at most α ¹
UNIF(μ,α)		Random number sampled from uniform distribution with mean μ and standard deviation $(\alpha * \mu)/n$ The number returned will differ from the mean by at most $\alpha * \mu$ ¹
LIMIT(x,y)		where x is the nominal value and y is the absolute variation. It will return $x+y$ or $x-y$, depending on a random number between -1 and +1.

Table 2-33. Arithmetic Functions

Function	Meaning	Explanation
RAND()		<p>Note: The three-argument version of limit, documented above, is not a random operator.</p> <hr/> <p>random number between 0 and 1 sampled from a uniform distribution¹</p>

¹The default behavior of the random number functions RAND, GAUSS, and AGAUSS, if there are not any UQ commands such as .SAMPLING in the netlist, is to return the mean value of the operator. If a UQ command is present, then these operators can be used to define the distribution of random inputs to the UQ analysis. However, this will only happen if the UQ analysis specifically requests it using the command .SAMPLING USEEXPR=TRUE Unless a specific random seed is specified using either the -randseed command line option, or from the netlist, the random number generator will be seeded internally. In all cases, Xyce will output text to the console indicating what seed is being used.

²Use of the IF function to create an expression that has step-function-like behavior as a function of a solution variable is highly likely to produce convergence errors in simulation. IF statements that have step-like behavior with an explicit time dependence are the exception, as the code will insert breakpoints at the discontinuities. Do not use step-function or other infinite-slope transitions dependent on variables other than time. Smooth the transition so that it is more easily integrated through. See the “Analog Behavioral Modeling” chapter of the Xyce Users’ Guide [1] for guidance on using the IF function with the B-source device.

³For all the interpolator functions, such as TABLE and SPLINE, the second and third arguments are optional. The second argument, *N*, toggles automatic sparsification of the data, where *N* is the requested number of data points. The third argument, *log* is a boolean. If true, the gradient-based sparsification uses a log scale. To specify *log*, the second parameter *N* must be specified first.

Spice Compatible Functions Expressions can also use functions that are the equivalent of standard sources.

Table 2-34. SPICE Compatibility Functions

Function	Explanation
SPICE_EXP(V1,V2,TD1,TAU1,TD2,TAU2)	SPICE style transient exponential V1 = initial value V2 = pulsed value TD1 = rise delay time TAU1 = rise time constant TD2 = fall delay time TAU2 = fall time constant
SPICE_PULSE(V1,V2,TD,TR,TF,PW,PER)	SPICE style transient pulse V1 = initial value V2 = pulsed value TD = delay TR = rise time TF = fall time PW = pulse width PER = period
SPICE_SFFM(V0,VA,FC,MDI,FS)	SPICE style transient single frequency FM V0 = offset VA = amplitude FC = carrier frequency MDI = modulation index FS = signal frequency
SPICE_SIN(V0,VA,FREQ,TD,THETA)	SPICE style transient sine wave V0 = offset VA = amplitude FREQ = frequency (hz) TD = delay THETA = damping factor

Information about the restrictions on expressions in specific contexts is given in the subsections that follow.

2.2.1. Expressions in .PARAM or .GLOBAL_PARAM Statements

Parameters defined using .PARAM and .GLOBAL_PARAM are mostly synonymous and subject to most of the same constraints. Both types are allowed to depend on parameters defined in .PARAM or .GLOBAL_PARAM

statements, and both may contain special variables such as TIME, FREQ, TEMP or VT. Neither type may contain any references to solution variables or lead currents.

Example: .PARAM SQUARES=5.0

Example: .PARAM SHEETRES=25

Example: .PARAM RESISTANCE={SQUARES*SHEETRES}

Example: .PARAM a0 = 1.0+2.0J

Example: .PARAM dTdt=.01

Example: .GLOBAL_PARAM Temperature={27+dTdt*TIME}

Both types of parameter are subject to extra constraints if used inside of subcircuits. .PARAM parameters may be defined inside of a subcircuit, while .GLOBAL_PARAM parameters may not. Parameters inside of subcircuits may not be swept by analysis commands such as .STEP or .SAMPLING. Only globally scoped user-defined parameters can be swept in this manner. Note, this restriction does not apply to device parameters, just user-defined parameters.

Parameters can be complex-valued. The suffix letter used for the imaginary part of a complex number is the letter J. For example, in the parameter statement .param a0=1.0+2.0J, the parameter a0 has 1.0 for the real part and 2.0 is the imaginary part.

Although parameters are allowed to be complex, many uses of parameters are inherently real-valued. Most device parameters, for example, are assumed to be double precision numbers. So, if a real-valued device parameter is set equal to a complex-valued .param, the device parameter will use the real part and the imaginary part will be ignored.

2.2.2. Expressions in .PRINT Lines

Expressions on .PRINT lines may contain references to parameters defined in either .PARAM or .GLOBAL_PARAM statements, device parameters using the syntax <device name>:<parameter name>, and may also contain solution variables.

```
*example with .print expressions
.PARAM RES=50
R1 1 0 {RES}
V1 1 0 sin(0 5 100khz)
.tran 1u 1m
*Print power dissipated through resistor,
*and actual resistance used in the R1
*device
.print tran {V(1)*V(1)/RES} {R1:R}
.end
```

2.2.3. Using Complex Values in Expressions

The Xyce expression library was written to work with complex quantities, and can perform complex arithmetic on any set of complex inputs to produce a complex output. However, the default behavior on the .PRINT line depends on the type of analysis being run.

If running a frequency domain analysis such as .AC or .HB, then outputs of complex valued expressions will automatically include both the real and imaginary part. For example:

```
.param r0={log(-1)}  
.print ac {r0} // automatically output real and imaginary parts
```

If running a real-valued analysis such as .DC or .TRAN, the output on the .PRINT line will, by default, only include the real part. This is true even if the expression evaluates to a complex number. If the user is running a real-valued analysis, but desires output of both the real and imaginary part, it is necessary to use operators such as Re() and Img(). Here are some examples.

```
.param r0={log(-1)}  
.print tran {r0} // only output the real part of {r0}  
.print tran {re(r0)} {img(r0)} // output both real and imaginary parts
```

Note any complex-valued expression will internally be evaluated using complex math. The only thing different for {r0} in the above examples is the default outputs for .AC and .TRAN.

2.2.4. Expressions for Device Instance and Model Parameters

Expressions of constants, .PARAM and .GLOBAL_PARAM parameters may be used for the values of any device parameters in instance and model lines.

Except in very specific devices, expressions used for device parameter values must evaluate to a time-independent constant, and must not contain dependence on solution variables such as nodal voltages or currents.

```
*example of use of expressions for device parameters  
.PARAM RES=50  
.GLOBAL_PARAM theSaturationCurrent=1.5e-14  
R1 1 0 {RES}  
V1 1 0 sin(0 5 100khz)  
D1 1 0 DMODEL  
.MODEL D DMODEL IS=theSaturationCurrent  
  
.step theSaturationCurrent 1e-14 5e-14 1e-14
```

Some parameters of specific devices are exceptions to the general rule. These parameters have no restrictions and may depend on any parameters, time, or solution variables in the netlist:

- The V or I instance parameters of the B source.
- The CONTROL instance parameter of the switch (S device).
- The C (capacitance) instance parameter for the capacitor.

- The Q (charge) instance parameter for the capacitor.
- The coupling coefficient instance parameter for the *LINEAR* mutual inductor (K device with no model card specified)

These specific instance parameters may be time-dependent (i.e. they may reference the TIME special variable), but may not depend on any solution variables:

- The TEMP instance parameter of all devices.
- The L (inductance) parameter of the inductor.
- The R (resistance) parameter of the resistor.
- The R, RESISTIVITY, DENSITY, HEATCAPACITY and THERMAL_HEATCAPACITY parameters of the thermal resistor (resistor level 2).

2.2.5. *POLY expressions*

The POLY keyword is available in the E, F, G, H and B dependent sources. Based on the same keyword from SPICE2, POLY provides a compact method of specifying polynomial expressions in which the variables in the polynomial are specified followed by an ordered list of polynomial coefficients. All expressions specified with POLY are ultimately translated by Xyce into an equivalent, straightforward polynomial expression in a B source. Since a straightforward polynomial expression can be easier to read, there is no real benefit to using POLY except to support netlists imported from other SPICE-based simulators.

There are three different syntax forms for POLY, which can be a source of confusion. The E and G sources (voltage-dependent voltage or current sources) use one form, the F and H sources (current-dependent voltage or current sources) use a second form, and the B source (general nonlinear source) a third form. During input processing, any of the E, F, G or H sources that use nonlinear expressions are first converted into an equivalent B source, and then any B sources that use the POLY shorthand are further converted into standard polynomial expressions. This section describes how the compact form will be translated into the final form that is used internally.

All three formats of POLY express the same three components: a number of variables involved in the expression (N , the number in parentheses after the POLY keyword), the variables themselves, and an ordered list of coefficients for the polynomial terms. Where they differ is in how the variables are expressed.

2.2.5.1. **Voltage-controlled sources**

The E and G sources are both voltage-controlled, and so their POLY format requires specification of two nodes for each voltage on which the source depends, i.e. the positive and negative nodes from which a voltage drop is computed. There must therefore be twice as many nodes as the number of variables specified in parentheses after the POLY keyword:

```
Epoly 1 2 POLY(3) n1p n1m n2p n2m n3p n3m ...
```

In this example, the voltage between nodes 1 and 2 is determined by a polynomial whose variables are $V(n1p, n1m)$, $V(n2p, n2m)$, $V(n3p, n3m)$. Not shown in this example are the polynomial coefficients, which will be described later.

2.2.5.2. Current-controlled sources

The F and H sources are both current-controlled, and so their POLY format requires specification of one voltage source name for each current on which the source depends. There must therefore be exactly as many nodes as the number of variables specified in parentheses after the POLY keyword:

```
Fpoly 1 2 POLY(3) V1 V2 V3 ...
```

In this example, the voltage between nodes 1 and 2 is determined by a polynomial whose variables are $I(V1)$, $I(V2)$, and $I(V3)$. Not shown in this example are the polynomial coefficients, which will be described later.

2.2.5.3. B sources

Finally, the most general form of POLY is that used in the general nonlinear dependent source, the B source. In this variant, each specific variable must be named explicitly (i.e. not simply by node name or by voltage source name), because currents and voltages may be mixed as needed.

```
Bpoly 1 2 V={POLY(3) I(V1) V(2,3) V(3) ...}
```

```
Bpoly2 1 2 I={POLY(3) I(V1) V(2,3) V(3) ...}
```

In these examples, the source between nodes 1 and 2 is determined by a polynomial whose variables are $I(V1)$, $V(2,3)$, and $V(3)$. In the first example, the polynomial value determines the voltage between nodes 1 and 2, and in the second the current.

The E, F, G and H formats are all converted internally in a first step to the B format. Thus the following pairs of sources are exactly equivalent:

```
Epoly 1 2 POLY(3) n1p n1m n2p n2m n3p n3m ...
```

```
BEpoly 1 2 V={POLY(3) V(n1p,n1m) V(n2p,n2m) V(n3p,n3m) ...}
```

```
Fpoly 1 2 POLY(3) V1 V2 V3 ...
```

```
BFpoly 1 2 V={POLY(3) I(V1) I(V2) I(V3) ...}
```

After conversion to the B source form, the POLY form is finally converted to a normal expression using the coefficients and variables given.

Coefficients are given in a standard order, and the polynomial is built up by terms until the list of coefficients is exhausted. The first coefficient is the constant term of the polynomial, followed by the coefficients of linear terms, then bi-linear, and so on. For example:

```
Epoly 1 2 POLY(3) n1p n1m n2p n2m n3p n3m 1 .5 .5 .5
```

In this example, the constant term is 1.0, and the coefficients of the three terms linear in the input variables are 0.5. Thus, this E source is precisely equivalent to the general B source:

```
BEstandard 1 2 V={1.0 + .5*V(n1p,n1m) + .5*V(n2p,n2m) + .5*V(n3p,n3m)}
```

The standard ordering for coefficients is:

```
POLY(N) X1 ... XN C0 C1 ... CN C11 ... C1N C21 ... CN1 ... CNN C121 ... C12N ...
```

with the polynomial then being:

$$Value = C_0 + \sum_{j=1}^N C_j X_j + \sum_{i=1}^N \sum_{j=1}^N C_{ij} X_i X_j + \sum_{i=1}^N \sum_{j=1}^N C_{i^2j} X_i^2 X_j + \dots$$

Here we have used the general form X_i for the i^{th} variable, which may be either a current or voltage variable in the general case.

It should be reiterated that the POLY format is provided primarily for support of netlists from other simulators, and that its compactness may be a disadvantage in readability of the netlist and may be more prone to usage error. Xyce users are therefore advised that use of the more straightforward expression format in the B source may be more appropriate when crafting original netlists for use in Xyce. Since Xyce converts POLY format expressions to the simpler format internally, there is no performance benefit to use of POLY.

2.3. Devices

Xyce supports many devices, with an emphasis on analog devices, including sources, subcircuits and behavioral models. This section serves as a reference for the devices supported by Xyce. Each device is described separately and includes the following information, if applicable:

- a description and an example of the correct netlist syntax.
- the matching model types and their description.
- the matching list of model parameters and associated descriptions.
- the corresponding characteristic equations for the model (as required).
- references to publications on which the model is based.

User-defined models may be implemented using the `.MODEL` (model definition) statement, and macromodels can be created as subcircuits using the `.SUBCKT` (subcircuit) statement.

Please note that the characteristic equations are provided to give a general representation of the device behavior. The actual Xyce implementation of the device may be slightly different in order to improve, for example, the robustness of the device.

Table 2-35 gives a summary of the device types and the form of their netlist formats. Each of these is described below in detail.

Table 2-35. Analog Device Quick Reference.

Device Type	Letter	Typical Netlist Format
Nonlinear Dependent Source (B Source)	B	B<name> <+ node> <- node> + <I or V>={<expression>}
Capacitor	C	C<name> <+ node> <- node> [model name] <value> + [IC=<initial value>]
Diode	D	D<name> <anode node> <cathode node> + <model name> [area value]
Voltage Controlled Voltage Source	E	E<name> <+ node> <- node> <+ controlling node> + <- controlling node> <gain>
Current Controlled Current Source	F	F<name> <+ node> <- node> + <controlling V device name> <gain>
Voltage Controlled Current Source	G	G<name> <+ node> <- node> <+ controlling node> + <- controlling node> <transconductance>
Current Controlled Voltage Source	H	H<name> <+ node> <- node> + <controlling V device name> <gain>
Independent Current Source	I	I<name> <+ node> <- node> [[DC] <value>] + [AC [magnitude value [phase value]]] + [transient specification]
Mutual Inductor	K	K<name> <inductor 1> [<ind. n>*] + <linear coupling or model>
Inductor	L	L<name> <+ node> <- node> [model name] <value> + [IC=<initial value>]

Table 2-35. Analog Device Quick Reference.

Device Type	Letter	Typical Netlist Format
JFET	J	J<name> <drain node> <gate node> <source node> + <model name> [area value]
MOSFET	M	M<name> <drain node> <gate node> <source node> + <bulk/substrate node> [SOI node(s)] + <model name> [common model parameter]*
Lossy Transmission Line (LTRA)	O	O<name> <A port (+) node> <A port (-) node> + <B port (+) node> <B port (-) node> + <model name>
Bipolar Junction Transistor (BJT)	Q	Q<name> <collector node> <base node> + <emitter node> [substrate node] + <model name> [area value]
Resistor	R	R<name> <+ node> <- node> [model name] <value> + [L=<length>] [W=<width>]
Voltage Controlled Switch	S	S<name> <+ switch node> <- switch node> + <+ controlling node> <- controlling node> + <model name>
Generic Switch	S	S<name> <+ switch node> <- switch node> + <model name> CONTROL={expression}
Transmission Line	T	T<name> <A port + node> <A port - node> + <B port + node> <B port - node> + <ideal specification>
Digital Devices	U	U<name> <type> <digital power node> + <digital ground node> [node]* <model name>
Independent Voltage Source	V	V<name> <+ node> <- node> [[DC] <value>] + [AC [magnitude value [phase value]]] + [transient specification]
Port Device	P	P<name> <+ node> <- node> [[DC] <value>] + port=port number [Z0 = value] + [AC [magnitude value [phase value]]] + [transient specification]
Subcircuit	X	X<name> [node]* <subcircuit name> + [PARAMS:[<name>=<value>]*]
Current Controlled Switch	W	W<name> <+ switch node> <- switch node> + <controlling V device name> <model name>
Digital Devices, Y Type (deprecated)	Y<type>	Y<type> <name> [node]* <model name>
PDE Devices	YPDE	YPDE <name> [node]* <model name>
Accelerated masses	YACC	YACC <name> <acceleration> <velocity> <position> + [x0=<initial position>] [v0=<initial velocity>]
Linear Device	YLIN	YLIN <name> <+ node> <- node> <model name>
Memristor Device	YMEMRISTOR	YMEMRISTOR <name> <+ node> <- node> <model name>
MESFET	Z	Z<name> <drain node> <gate node> <source node> + <model name> [area value]

Table 2-36. Features Supported by Xyce Device Models

Device	Comments	Branch Current	Power	Analytic Sensitivity	Stationary Noise
Capacitor	Age-aware, semiconductor	Y	Y	Y	
Inductor	Coupled mutual inductors (see below)	Y	Y	Y	
Linear and Nonlinear Mutual Inductor		Y	Y		
Resistor (Level 1)	Normal and Semiconductor	Y	Y	Y	Y
Resistor (Level 2)	Thermal Resistor	Y	Y		
Diode (Level 1)		Y	Y	Y	Y
Diode (Level 2)	Addition of PSpice enhancements	Y	Y		
Diode (Level 200)	JUNCAP200 model	Y	Y	Y	Y
Independent Voltage Source (VSRC)		Y	Y	Y	
Independent Current Source (ISRC)		Y	Y	Y	
Voltage Controlled Voltage Source (VCVS)		Y	Y		
Voltage Controlled Current Source (VCCS)		Y	Y		
Current Controlled Voltage Source (CCVS)		Y	Y		
Current Controlled Current Source (CCCS)		Y	Y		
Port Device		Y	Y		
Nonlinear Dependent Source (B Source)		Y	Y		
Bipolar Junction Transistor (BJT) (Level 1)		Y	Y	Y	Y
Bipolar Junction Transistor (BJT) (Level 11)	Vertical Bipolar Intercompany (VBIC) model, version 1.3 (3-terminal)	Y	Y	Y	Y
Bipolar Junction Transistor (BJT) (Level 12)	Vertical Bipolar Intercompany (VBIC) model, version 1.3 (4-terminal)	Y	Y	Y	Y
Bipolar Junction Transistor (BJT) (Level 23)	FBH (Ferdinand-Braun-Institut für Höchstfrequenztechnik) HBT model, version 2.1	Y	Y	Y	N
Bipolar Junction Transistor (BJT) (Level 230)	HICUM Level 0	Y	Y	Y	Y
Bipolar Junction Transistor (BJT) (Level 234)	HICUM Level 2	Y	Y	Y	Y

Table 2-36. Features Supported by Xyce Device Models

Device	Comments	Branch Current	Power	Analytic Sensitivity	Stationary Noise
Bipolar Junction Transistor (BJT) (Level 504)	MEXTRAM version 504.12.1	Y	Y	Y	Y
Bipolar Junction Transistor (BJT) (Level 505)	MEXTRAM version 504.12.1 (with self-heating)	Y	Y	Y	Y
Junction Field Effect Transistor (JFET) (Level 1)	SPICE-compatible JFET model	Y	Y		
Junction Field Effect Transistor (JFET) (Level 2)	Shockley JFET model	Y	Y		
MESFET		Y	Y		
MOSFET (Level 1)		Y	Y		Y
MOSFET (Level 2)	SPICE level 2 MOSFET	Y	Y		Y
MOSFET (Level 3)		Y	Y		Y
MOSFET (Level 6)	SPICE level 6 MOSFET	Y	Y		Y
MOSFET (Level 9)	BSIM3 model	Y	Y	Y	Y
MOSFET (Level 10)	BSIM SOI model	Y	Y		
MOSFET (Level 14 or 54)	BSIM4 model	Y	Y		
MOSFET (Level 18)	VDMOS general model	Y	Y		
MOSFET (Level 77)	BSIM6 model version 6.1.1	Y	Y	Y	Y
MOSFET (Level 102)	Legacy PSP model	Y	Y	Y	Y
MOSFET (Level 103)	PSP model	Y	Y	Y	Y
MOSFET (Level 107)	BSIM-CMG version 107.0.0	Y	Y	Y	Y
MOSFET (Level 110)	BSIM-CMG version 110.0.0	Y	Y	Y	Y
MOSFET (Level 301)	EKV model version 3.0.1	Y	Y	Y	Y
MOSFET (Level 2000)	MVS ETSOI model version 2.0.0	Y	Y	Y	Y
MOSFET (Level 2001)	MVS HEMT model version 2.0.0	Y	Y	Y	Y
Transmission Line (TRA)	Lossless	Y	Y		
Transmission Line (LTRA)	Lossy				
Lumped Transmission Line	Lossy or Lossless				
Controlled Switch (S,W) (VSWITCH/ISWITCH)	Voltage or current controlled	Y	Y		

Table 2-36. Features Supported by Xyce Device Models

Device	Comments	Branch Current	Power	Analytic Sensitivity	Stationary Noise
Generic Switch (SW)	Controlled by an expression	Y	Y		
PDE Devices (Level 1)	one-dimensional	Y			
PDE Devices (Level 2)	two-dimensional	Y			
Digital (Level 1)	Behavioral Digital	NA	NA		
ACC	Accelerated mass device, used for simulation of electromechanical and magnetically-driven machines	NA	NA		
Power Grid	Separate models for Branch, Bus Shunt, Transformer and Generator Bus. The Generator Bus model supports reactive power (Q) limiting				
Memristor	TEAM formulation	Y	Y		
Memristor	Yakopic	Y	Y		
Memristor	PEM Formulation	Y	Y		

2.3.1. Voltage Nodes

Devices in a netlist are connected between *nodes*, and all device types in Xyce require at least two nodes on each instance line. Section 2.3.2 lists the characters that are legal and illegal in Xyce node and device names.

A node is simply a named point in the circuit. The naming of nodes is mainly known within the level of circuit hierarchy where they appear. Nodes can be passed into subcircuits through an argument list, and in this manner subcircuits are given access to nodes from the upper-level circuit. Historically, this is how nodes are passed through the circuit hierarchy in most circuit simulators, and this is the convention used by most circuit netlists. However, Xyce has two exceptions to this convention. Global nodes, described in section 2.3.1.1 and fully resolved internal subcircuit nodes, described in section 2.3.1.2.

2.3.1.1. Global nodes

A special syntax is used to designate certain nodes as *global* nodes. Any node whose name starts with the two characters “\$G” is a global node, and such nodes are available to be used in any subcircuit. A typical usage of such global nodes is to define a VDD or VSS signal that all subcircuits need to be able to access, but without having to provide VSS and VDD input nodes to every subcircuit. In this case, a global \$GVDD node would be used for the VDD signal.

The node named 0 is a special global node. Node 0 is always ground, and is accessible to all levels of a hierarchical netlist.

For compatibility with HSPICE, the .GLOBAL command can be used to define global nodes that do not start with the two characters “\$G”. See section 2.1.11 for more details.

2.3.1.2. Subcircuit Nodes

Hierarchical netlists may be created using .SUBCKT [2.1.37] to define common subcircuit types, and X [2.3.33] lines to create instances of those subcircuits. There are two types of nodes associated with such subcircuits, *interface* nodes and *internal* nodes.

Interface nodes are the nodes named on the .SUBCKT line. These are effectively local aliases internal to the subcircuit definition for the node names used on the X instance lines. Internal nodes are nodes inside the subcircuit definition that are strictly local to that subcircuit. Inside a subcircuit, these node names may be used without restriction in device instance lines and expressions on B source lines.

There are some circumstances when it is desirable to access internal nodes of a subcircuit from outside that subcircuit. Xyce provides a syntax that allows this to be done. The primary context in which this is supported is on .PRINT lines, to allow the user to print out signals that are usually local to a subcircuit. However, this syntax isn't limited to .PRINT lines, and can work in other contexts.

The syntax used by Xyce to refer to nodes within a subcircuit is to prefix the name of the node with the full path of subcircuit instances in which the node is contained, with colons (:) separating the instance names. So, to reference a node “A” that is inside a subcircuit instance called “Xnot1” inside another subcircuit instance called “Xmain”, one would refer to “Xmain:Xnot1:A”.

Note that while the default separator in Xyce is the colon (:), the period (.) is also optionally supported. For more information about using a period separator, see section 3.

The same syntax works on .PRINT lines even if the subcircuit node is one of the interface nodes on the .SUBCKT line, but those nodes can also be accessed by using the names of the nodes at the higher level of circuit hierarchy that are used on its instance line.

```
* Netlist demonstrating subcircuit node .PRINT access
V1 1 0 1
X1 1 2 demosubc
X2 2 0 demosubc
.subckt demosubc A B
R1 A C 1
R2 C B 1
.ends

.dc V1 1 5 1

*V(X1:A) and V(1) are the same signal.
*V(X1:C) is the internal C node of the X1 instance
*V(X2:C) is the internal C node of the X2 instance
*V(X1:B), V(X2:A) and V(2) are the same signal
.print DC V(X1:C) V(X2:C) V(X1:A) V(1)
+ V(X1:B) V(X2:A) V(2)
.end
```

Internal subcircuit nodes may also be accessed from outside of the subcircuit if one uses the fully resolved syntax. This works in B source voltage or current expressions, and also in standard netlist usage on device instance lines. This type of usage is outside of the typically strict hierarchy required by most circuit simulators, but it can be useful in some contexts.

The one difference between this usage and .PRINT usage is that it is not possible to use the subcircuit node syntax to access interface nodes. These must be accessed using the node names being used on the instance line, as in the “V(1)” example in the netlist fragment above. Two valid examples of internal subcircuit node access are given by the fragment below.

```
* Netlist demonstrating resolved subcircuit nodes
Vin 1 0 1.0
X1 1 2 test
Rout 2 0 1.0
.subckt test A B
Rt1 A testNode 1.0
Rt2 testNode B 1.0
.ends

* this works:
Btest1 3 0 V = V(X1:testNode)
Rtest1 3 0 1.0
* this also works:
Itest2 0 4 1.0
Rtest2 X1:testNode 4 1.0
Rtest3 X1:testNode 0 1.0
```

2.3.2. Legal Characters in Node and Device Names

Xyce node names and device names can consist of any printable ASCII characters, with the following exceptions and caveats which may be different than other SPICE-like circuit simulators. The exceptions are:

- White space (space, tab, newline) is not allowed.
- Parentheses (“(” or “)”), braces (“{” or “}”), commas, colons, semi-colons, double quotes and single quotes are also not allowed, since they do not work correctly in node names or device names in all netlist contexts in Xyce.

The caveats are as follows:

- The star (*) and question mark (?) characters are allowed in both node names and device names. However, those two characters also function as “print wildcards” in Xyce, per section 2.1.31.11. So, that usage is discouraged.
- Global nodes in Xyce begin with the two characters “\$G”.
- The node named 0 (“zero”) is a special global node, which is always the ground node.
- These arithmetic operators % ^ & ? : ~ * - + < > / | should not be used in node or device names that will be used outside of a Xyce “operator”, such as V(), within a Xyce expression. Examples of this caveat are given below.
- The # character should not be used as the first character of a node name that will be used within an expression. Examples of this caveat are also given below.

These are some examples of the caveats of the use of arithmetic operators and # character within expressions:

```
* Okay since the + in the node name is enclosed within the V() operator.
.PRINT TRAN {V(1+) - V(+)}
* Okay since the R+ and R- device names are enclosed within the I() operator.
.PRINT TRAN {I(R+) * I(R-)}
* Okay, for printing the resistance value, since the R-1 device name
* is not used in an expression.
.PRINT TRAN R-1:R
* Will produce a parsing error, since the R-1 device name is used outside
* of an operator. That makes this statement ambiguous within an expression.
.PRINT TRAN {R-1:R}
* These uses of # are okay.
.PRINT TRAN V(#) {V(1#) -1}
* These usages of # are parsing errors, since # is the first character
* in the node names.
.PRINT TRAN {V(#) - 2} {V(#1) -1}
```

2.3.3. **Lead Currents and Power Calculations**

For some devices, such as independent voltage and current sources, the current through that device is a “solution” variable. For other devices, the current through the device is a “lead current”, whose value is calculated during a post-processing step. This approach has ramifications in Xyce for the availability and accuracy of lead current values. In particular, both lead currents and power calculations need to have been explicitly enabled for a given device, analysis type (e.g., .AC) or netlist command (e.g., .MEASURE).

For voltage sources, both V and I are solution variables. So, their accuracy is more likely to be limited by the nonlinear solver tolerances (RELTOL and ABSTOL). The lead current accuracy, for a device like the resistor, can also be limited by the right-hand side tolerance RHSTOL. So, the calculated lead currents through very small resistances (e.g., 1e-12) may be inaccurate if the default solver tolerances for Xyce are used.

Lead currents have the following additional limitations:

- They are not enabled for .AC analyses.
- They are not allowed in the expression controlling a B-Source.
- They do not work for .RESULT statements.

Lead currents and power calculations are available in .MEASURE and .FOUR statements.

At this time the power calculations are only supported for .DC and .TRAN analysis types and for a limited set of devices. In addition, the results for semiconductor devices (D, J, M, Q and Z devices) and the lossless transmission device (T device) may differ from other simulators. Consult the Features Supported by Xyce Device Models table in section 2.3 and the individual sections on each device for more details.

As an example, the power supplied or dissipated by the voltage source V is calculated as $I \cdot \Delta V$ where the voltage drop is calculated as $(V_+ - V_-)$ and positive current flows from V_+ to V_- . Dissipated power has a positive sign, while supplied power has a negative sign.

An important note is that the power calculations are also a post-processing step, which places a limit on the accuracy of circuit-wide “energy conservation” calculations (e.g., total power supplied by sources - total power dissipated in non-source devices) in Xyce. The accuracy of the inputs (V and I) to the power calculations is limited by the nonlinear solver and right-hand side tolerances, as noted above, and the error in the power calculations is upper-bounded by the sum of the product-terms of $V \cdot (\text{error in } I)$ and $I \cdot (\text{error in } V)$.

2.3.4. Capacitor

Symbol



Instance Form

C<device name> <(+) node> <(-) node> [model name] [value]
+ [device parameters]

Model Form

.MODEL <model name> C [model parameters]
.MODEL <model name> CAP [model parameters]

Examples

```
CM12 2 4 5.288e-13
CLOAD 1 0 4.540pF IC=1.5V
CFEEDBACK 2 0 CMOD 1.0pF
CAGED 2 3 4.0uF D=0.0233 AGE=86200
CSOLDEP 3 0 C={ca*(c0+c1*tanh((V(3,0)-v0)/v1))}
CSOLDEPQ 3 0 Q={ca*(c1*v1*ln(cosh((v(3,0)-v0)/v1))+c0*v(3,0))}
```

Parameters and
Options

device name

The name of the device.

(+) node

(-) node

Polarity definition for a positive voltage across the capacitor. The first node is defined as positive. Therefore, the voltage across the component is the first node voltage minus the second node voltage.

model name

If `model name` is omitted, then `value` is the capacitance in farads. If [model name] is given then the value is determined from the model parameters; see the capacitor value formula below.

value

Positional specification of device parameter C (capacitance). Alternately, this can be specified as a parameter, C=<value>, or in the (optional) model.

device parameters

Parameters listed in Table 2-37 may be provided as space separated <parameter>=<value> specifications as needed. Any number of parameters may be specified.

model parameters

Parameters listed in Table 2-38 may be provided as space separated <parameter>=<value> specifications as needed. Any number of parameters may be specified.

Comments Positive current flows through the capacitor from the (+) node to the (-) node. In general, capacitors should have a positive capacitance value (<value> property). In all cases, the capacitance must not be zero.

However, cases exist when a negative capacitance value may be used. This occurs most often in filter designs that analyze an RLC circuit equivalent to a real circuit. When transforming from the real to the RLC equivalent, the result may contain a negative capacitance value.

In a transient run, negative capacitance values may cause the simulation to fail due to instabilities they cause in the time integration algorithms.

The power stored or released from the capacitor is calculated with $I \cdot \Delta V$ where the voltage drop is calculated as $(V_+ - V_-)$ and positive current flows from V_+ to V_- .

For compatibility with PSpice, either C or CAP can be used in a .MODEL statement for a capacitor.

The Multiplicity Factor (M) can be used to specify multiple, identical capacitors in parallel. The effective capacitance becomes $C \cdot M$. The M value need not be an integer. It can be any positive real number. M can not be used as a model parameter.

Device Parameters

Table 2-37. Capacitor Device Instance Parameters

Parameter	Description	Units	Default
AGE	Age of capacitor	hour	0
C	Capacitance	F	1e-06
D	Age degradation coefficient	–	0.0233
DTEMP	Device delta temperature	°C	0
IC	Initial voltage drop across device	V	0
L	Semiconductor capacitor width	m	1
M	Multiplicity Factor	–	1
Q	Charge	C	0
TC1	Linear Temperature Coefficient	°C ⁻¹	0
TC2	Quadratic Temperature Coefficient	°C ⁻²	0
TEMP	Device temperature	°C	Ambient Temperature
W	Semiconductor capacitor length	m	1e-06

In addition to the parameters shown in the table, the capacitor supports a vector parameter for the temperature correction coefficients. TC1=<linear coefficient> and TC2=<quadratic coefficient> may therefore be specified compactly as TC=<linear coefficient>,<quadratic coefficient>.

Model Parameters

Table 2-38. Capacitor Device Model Parameters

Parameter	Description	Units	Default
C	Capacitance multiplier	–	1
CJ	Junction bottom capacitance	F/m ²	0
CJSW	Junction sidewall capacitance	F/m	0
DEFW	Default device width	m	1e-06
NARROW	Narrowing due to side etching	m	0
TC1	Linear temperature coefficient	°C ⁻¹	0
TC2	Quadratic temperature coefficient	°C ⁻²	0
TNOM	Nominal device temperature	°C	Ambient Temperature

Capacitor Equations

Capacitance Value Formula If [model name] is specified, then the capacitance is given by:

$$C \cdot (1 + \text{TC1} \cdot (T - T_0) + \text{TC2} \cdot (T - T_0)^2)$$

where C is the base capacitance specified on the device line and is normally positive (though it can be negative, but not zero). T_0 is the nominal temperature (set using **TNOM** option).

Age-aware Formula If **AGE** is given, then the capacitance is:

$$C[1 - \text{D} \log(\text{AGE})]$$

Semiconductor Formula If [model name] and **L** and **W** are given, then the capacitance is:

$$\text{CJ}(\text{L} - \text{NARROW})(\text{W} - \text{NARROW}) + 2 \cdot \text{CJSW}(\text{L} - \text{W} + 2 \cdot \text{NARROW})$$

Solution-Dependent Capacitor If the capacitance (C) is set equal to an expression then a “solution-dependent” capacitor is used, where the capacitance is a function of other simulation variables. The formulas for temperature-dependence and age-dependence, given above, then use that calculated C value.

If the parameter Q is set equal to an expression *instead* of specifying a capacitance, this expression is used to evaluate the charge on the capacitor instead of computing it from capacitance. Temperature and age dependence are not computed in this case, as these effects are applied by modifying the capacitance.

Both solution-dependent charge and capacitance formulations are implemented to assure charge conservation. The capacitor:

$$c_mcap \ 1 \ 2 \ q = \{c_a * (c_1 * v_1 * \ln(\cosh((v(1,2) - v_0)/v_1)) + c_0 * v(1,2))\}$$

is exactly equivalent to the capacitor

$$c_mcap \ 1 \ 2 \ c = \{c_a * (c_0 + c_1 * \tanh((V(1,2) - v_0)/v_1))\}$$

because the capacitance is the derivative of the charge with respect to the voltage drop across the capacitor. Similarly, both are equivalent to the behavioral source:

$$BC \ 1 \ 2 \ I = ddt(V(1,2)) * (c_a * (c_0 + c_1 * \tanh((V(1,2) - v_0)/v_1)))$$

because $I = dQ/dt = dQ/dV * dV/dt = C * dV/dt$.

The restrictions for this formulation are:

- The expression used for C or Q must only use solution variables, which are node voltages and also branch currents for source devices. It may not use device lead currents, which are post-processed quantities that are not solution variables.
- The expression must not use time derivatives.
- Capacitance (C) and Charge (Q) are the only instance or model parameters that are allowed to be solution-dependent.

Other Restrictions and Caveats A netlist parsing error will occur if:

- Neither the C, Q, nor L instance parameters are specified.
- Both C and Q are specified as expressions.
- Q is specified in addition to an IC=.
- The A instance parameter is specified for a semiconductor capacitor (which is specified via L, W and CJSW).

If both the C and L instance parameters are specified then C will be used, rather than the semiconductor formulation.

Special note on Initial Conditions: The IC parameter of the capacitor may be used to specify an initial voltage drop on the capacitor. Unlike SPICE3F5, this parameter is never ignored (SPICE3F5 only respects it if UIC is used on a transient line). The initial condition is applied differently depending on the analysis specified.

If one is doing a transient with DC operating point calculation or a DC operating point analysis, the initial condition is applied by inserting a voltage source across the capacitor to force the operating point to find a solution with the capacitor charged to the specific voltage. The resulting operating point will be one that is consistent with the capacitor having the given voltage in steady state.

If one specifies UIC or NOOP on the .TRAN line, then Xyce does not perform an operating point calculation, but rather begins a transient simulation directly given an initial state for the solution. In this case, IC initial conditions are applied only for the first iteration of the Newton solve of the first time step — the capacitor

uses the initial condition to compute its charge, and the nonlinear solver will therefore find a solution to the circuit problem consistent with this charge, i.e., one with the correct voltage drop across the capacitor.

The caveats of this section apply only to initial conditions specified via IC= parameters on the capacitor, and do not affect how initial conditions are applied when using .IC lines to specify initial conditions on node values.

The three different ways of specifying initial conditions can lead to different circuit behaviors. Notably, when applying initial conditions during a DC operating point with IC= on the capacitor line, the resulting operating point will be a DC solution with currents everywhere consistent with there being a constant charge on the capacitor, whereas in general a transient run from an initial condition *without* having performed an operating point calculation will have a quiescent circuit at the first timestep.

2.3.5. Inductor

Symbol



Instance Form L<name> <(+) node> <(-) node> [model] <value> [device parameters]

Model Form .MODEL <model name> L [model parameters]
 .MODEL <model name> IND [model parameters]

Examples L1 1 5 3.718e-08
 LM 7 8 L=5e-3 M=2
 LLOAD 3 6 4.540mH IC=2mA
 Lmodded 3 6 indmod 4.540mH
 .model indmod L (L=.5 TC1=0.010 TC2=0.0094)

Parameters and Options

(+) node

(-) node

Polarity definition for a positive voltage across the inductor. The first node is defined as positive. Therefore, the voltage across the component is the first node voltage minus the second node voltage.

initial value

The initial current through the inductor during the bias point calculation.

Comments

In general, inductors should have a positive inductance value. The inductance must not be zero. Also, a netlist parsing error will occur if no value is specified for the inductance.

However, cases exist when a negative value may be used. This occurs most often in filter designs that analyze an RLC circuit equivalent to a real circuit. When transforming from the real to the RLC equivalent, the result may contain a negative inductance value.

The power stored or released from the inductor is calculated with $I \cdot \Delta V$ where the voltage drop is calculated as $(V_+ - V_-)$ and positive current flows from V_+ to V_- .

If a model name is given, the inductance is modified from the value given on the instance line by the parameters in the model card. See "Inductance Value Formula" below.

When an inductor is named in the list of coupled inductors in a mutual inductor device line (see page 194), and that mutual inductor is of the nonlinear-core type, the <value> is interpreted as a number of turns rather than as an inductance in Henries.

For compatibility with PSpice, either L or IND can be used in a .MODEL statement for an inductor.

The Multiplicity Factor (M) can be used to specify multiple, identical inductors in parallel. The effective inductance becomes L/M . However, the value for the IC instance parameter is not multiplied by the M value. The M value need not be an integer. It can be any positive real number. M can not be used as a model parameter.

Device Parameters

Table 2-39. Inductor Device Instance Parameters

Parameter	Description	Units	Default
DTEMP	Device delta temperature	°C	0
IC	Initial current through device	A	0
L	Inductance	henry	0
M	Multiplicity Factor	–	1
TC1	Linear Temperature Coefficient	°C ⁻¹	0
TC2	Quadratic Temperature Coefficient	°C ⁻²	0
TEMP	Device temperature	°C	Ambient Temperature

Model Parameters

Table 2-40. Inductor Device Model Parameters

Parameter	Description	Units	Default
IC	Initial current through device	A	0
L	Inductance Multiplier	–	1
TC1	First order temperature coeff.	°C ⁻¹	0
TC2	Second order temperature coeff.	°C ⁻²	0
TNOM	Reference temperature	°C	27

In addition to the parameters shown in the table, the inductor supports a vector parameter for the temperature correction coefficients. TC1=<linear coefficient> and TC2=<quadratic coefficient> may therefore be specified compactly as TC=<linear coefficient>,<quadratic coefficient>.

Inductor Equations

Inductance Value Formula If [model name] is specified, then the inductance is given by:

$$L_{base} \cdot L \cdot (1 + TC1 \cdot (T - T_0) + TC2 \cdot (T - T_0)^2)$$

where L_{base} is the base inductance specified on the device line and is normally positive (though it can be negative, but not zero). L is the inductance multiplier specified in the model card. T_0 is the nominal temperature (set using **TNOM** option).

2.3.6. Mutual Inductors

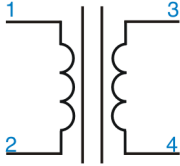
Symbol	
Instance Form	<code>K<name> L<inductor name> [L<inductor name>*] + <coupling value> [model name]</code>
Model Form	<code>.MODEL <model name> CORE [model parameters]</code>
Examples	<pre>ktran1 l1 l2 l3 1.0 KTUNED L3OUT L4IN .8 KTRNSFRM LPRIMARY LSECNDRY 1 KXFRM L1 L2 L3 L4 .98 KPOT_3C8</pre>

Parameters and Options

inductor name

Identifies the inductors to be coupled. The inductors are coupled and in the dot notation the dot is placed on the first node of each inductor. The polarity is determined by the order of the nodes in the L devices and not by the order of the inductors in the K statement.

If more than two inductors are given on a single K line, each inductor is coupled to all of the others using the same coupling value.

coupling value

The coefficient of mutual coupling, which must be between -1.0 and 1.0 .

This coefficient is defined by the equation

$$\langle \text{coupling value} \rangle = \frac{M_{ij}}{\sqrt{L_i L_j}}$$

where

L_i is the inductance of the i th named inductor in the K-line

M_{ij} is the mutual inductance between L_i and L_j

For transformers of normal geometry, use 1.0 as the value. Values less than 1.0 occur in air core transformers when the coils do not completely overlap.

model name

If `model name` is present, four things change:

- The mutual coupling inductor becomes a nonlinear, magnetic core device.
- The inductors become windings, so the number specifying inductance now specifies the number of turns.
- The list of coupled inductors could be just one inductor.

- If two or more inductors are listed, each inductor is coupled to all others through the magnetic core.
- A model statement is required to specify the model parameters.

Comments Lead currents and power calculations are supported for the component inductors in both linear and nonlinear mutual inductors. They are not supported for the composite mutual inductor though. So, if L1 is a component inductor for mutual inductor K1, then requests for I(L1), P(L1) and W(L1) will return lead current and power values as defined in Section 2.3.5. However, any usage of I(K1), P(K1) and W(K1) will result in a Xyce netlist parsing error.

Model Parameters

Table 2-41. Nonlinear Mutual Inductor Device Model Parameters

Parameter	Description	Units	Default
A	Thermal energy parameter	A/m	1000
ALPHA	Domain coupling parameter	–	5e-05
AREA	Mean magnetic cross-sectional area	cm ²	0.1
BETAH	Modeling constant	–	0.0001
BETAM	Modeling constant	–	3.125e-05
BHSIUNITS	Flag to report B and H in SI units	–	0
C	Domain flexing parameter	–	0.2
CLIM	Value below which domain flexing parameter will be treated as zero.	–	0.005
CONSTDELVSCALING	Use constant scaling factor to smooth voltage difference over first inductor	V	false
DELVSCALING	Smoothing coefficient for voltage difference over first inductor	V	1000
FACTORMS	Flag to factor the saturation magnetization from the magnetics equation.	–	0
GAP	Effective air gap	cm	0
INCLUDEMEQU	Flag to include the magnetics in the solution.	–	true
K	Domain anisotropy parameter	A/m	500
KIRR	Domain anisotropy parameter	A/m	500
LEVEL	for pspice compatibility – ignored	–	0
MEQNSCALING	M-equation scaling	–	1
MS	Saturation magnetization	A/m	1e+06
MVARSCALING	M-variable scaling.	–	1
OUTPUTSTATEVARS	Flag to save state variables	–	0
PACK	for pspice compatibility – ignored	–	0
PATH	Total mean magnetic path	cm	1

Table 2-41. Nonlinear Mutual Inductor Device Model Parameters

Parameter	Description	Units	Default
PZEROTOL	Tolerance for nonlinear zero crossing	–	0.1
REQNSCALING	R-equation scaling	–	1
RVARSCALING	R-variable scaling	–	1
TC1	First order temperature coeff.	–	0
TC2	Second order temperature coeff.	–	0
TNOM	Reference temperature	°C	27

Note that Xyce’s default value for the GAP parameter as zero. Some simulators will use non-zero values of the GAP as a default. When using netlists from other simulators in Xyce, ensure that the default parameters are consistent.

Special Notes The coupling coefficient of the linear mutual inductor (i.e. a mutual inductor without a core model) is permitted to be a time- or solution variable-dependent expression. This is intended to allow simulation of electromechanical devices in which there might be moving coils that interact with fixed coils.

Additionally, for linear mutual inductors, different coupling terms can be applied to different pairs of inductors with this syntax:

```
L1 1 2 2.0e-3
L2 0 3 8.1e-3
L3 3 4 8.1e-3
ktran1 11 12 0.7
ktran2 12 13 0.9
ktran3 11 13 0.99
```

Nonlinear mutual inductors can output $B(t)$ and $H(t)$ variables so that one can plot $B - H$ loops. On the .print line the B and H variables are accessible using the node output syntax as in n(non-linear-inductor-name_b) for B and n(non-linear-inductor-name_h) for H . A confusing aspect of this is that the non-linear inductor name is the *internal* name used by Xyce. For example, consider this circuit which defines a nonlinear mutual inductor at both the top level of the circuit and within a subcircuit:

* Test Circuit for Mutually Coupled Inductors

```
VS 0 1 SIN(0 169.7 60HZ)
R1 1 2 1K
R2 3 0 1K
L1 2 0 10
L2 3 0 20
K1 L1 L2 0.75 txmod
.model txmod core
```

```

.subckt mysub n1 n2 n3
r1s n1 n2 1000
r2s n3 0 1000
L1s n2 0 10
L2s n3 0 20
k1s L1s L2s 0.75 txmod
.ends

xtxs 1 4 5 mysub

.TRAN 100US 25MS

* output the current through each inductor and the B & H values.
.PRINT TRAN I(L1) I(L2) n(ymin!k1_b) n(ymin!k1_h)
+ I(xtxs:L1s) I(xtxs:l2s) n(xtxs:ymin!k1s_b) n(xtxs:ymin!k1s_h)

.END

```

The internal, Xyce name of the non-linear mutual inductor is YMIN!K1 or ymin!k1 as the name is not case-sensitive. The device k1s is declared within a subcircuit called xtxs. Thus, its full name is xtxs:ymin!k1s. The reason for this is that both the linear and non-linear mutual inductors are devices that are collections of other devices, inductors in this case. Rather than use one of the few remaining single characters left to signify a new device, Xyce uses Y devices as an indicator of an extended device set, where the characters after the Y denote the device type and then the device name. Here, ymin means a min device which is a *mutual-inductor, non-linear* device. Thus, to print the *B* or *H* variable of the non-linear mutual inductor called k1 one would use n(ymin!k1_b) and n(ymin!k1_h) respectively for a .print line that looks like this:

```
.PRINT TRAN I(L1) I(L2) n(ymin!k1_b) n(ymin!k1_h)
```

And if the mutual inductor is in a subcircuit called xtxs then the .print line would look like this:

```
.PRINT TRAN I(xtxs:L1s) I(xtxs:l2s) n(xtxs:ymin!k1s_b) n(xtxs:ymin!k1s_h)
```

The above example also demonstrates how one outputs the current through inductors that are part of mutual inductors. The syntax is I(inductor name).

Note that while MKS units are used internally in Xyce, *B* and *H* are output by default in the SI units of Gauss for *B* and Oersted for *H*. To convert *B* to units of Tesla divide Xyce's output by 10,000. To convert *H* to units of *A/m* divide Xyce's output by $4\pi/1000$. Additionally, one can set the .model CORE parameter BHSIUNITS to 1 to force *B* and *H* to be output in MKS units.

Finally, one can access the *B* and *H* data via the .model CORE line. On the nonlinear mutual inductor's .model line, set the option OUTPUTSTATEVARS=1. This will cause Xyce to create a unique file for each nonlinear mutual inductor that uses this .model line with a name of the form Inductor_device_name. There are five columns of data in this file: time (*t*), magnetic moment (*M*), total current flux (*R*), flux density (*B*) and magnetic field strength (*H*). As with data output on the .print line, SI units are used such that *B* is output with units of Gauss and *H* in Oersted. As mentioned earlier, setting the model flag BHSIUNITS to 1 causes the output of *B* and *H* uses MKS units of Tesla and *A/m* respectively.

Mutual Inductor Equations The voltage to current relationship for a set of linearly coupled inductors is:

$$V_i = \sum_{j=1}^N c_{ij} \sqrt{L_i L_j} \frac{dI_j}{dt} \quad (2.3)$$

Here, V_i is the voltage drop across the i th inductor in the coupled set. The coupling coefficient between a pair of inductors is c_{ij} with a value typically near unity and L is the inductance of a given inductor which has units of *Henry's* (1 Henry = 1H = Volt · s/Amp)

For nonlinearly coupled inductors, the above equation is expanded to the form:

$$V_i = \left[1 + \left(1 - \frac{\ell_g}{\ell_t} \right) P(M, I_1 \dots I_N) \right] \sum_{j=1}^N L_{oij} \frac{dI_j}{dt} \quad (2.4)$$

This is similar in form to the linearly coupled inductor equation. However, the coupling has become more complicated as it now depends on the magnetic moment created by the current flow, M . Additionally, there are geometric factors, ℓ_g and ℓ_t which are the effective air gap and total mean magnetic path for the coupled inductors. The matrix of terms, L_{oij} is defined as

$$L_{oij} = \frac{\mu_0 A_c N_i N_j}{\ell_t} \quad (2.5)$$

and it represents the physical coupling between inductors i and j . In this expression, N_i is the number of windings around the core of inductor i , μ_0 is the magnetic permeability of free space which has units of Henries per meter and a value of $4\pi \times 10^{-7}$ and A_c is the mean magnetic cross-sectional area.

The magnetic moment, M is defined by:

$$\frac{dM}{dt} = \frac{1}{\ell_t} P \sum_{i=1}^N N_i \frac{dI_i}{dt} \quad (2.6)$$

and the function P is defined as:

$$P = \frac{cM'_{an} + (1 - c)M'_{irr}}{1 + \left(\frac{\ell_g}{\ell_t} - \alpha \right) cM'_{an} + \frac{\ell_g}{\ell_t} (1 - c)M'_{irr}} \quad (2.7)$$

If $c < \text{CLIM}$, then c is treated as zero in the above equation and Xyce simplifies the formulation. In this case, the magnetic-moment equation will not be needed and it will be dropped from the formulation. One can control this behavior by modifying the value of CLIM.

The remaining functions are:

$$M'_{an} = \frac{M_s A}{(A + |H_e|)^2} \quad (2.8)$$

$$H_e = H + \alpha M \quad (2.9)$$

$$H = H_{app} - \frac{\ell_g}{\ell_t} M \quad (2.10)$$

$$H_{app} = \frac{1}{\ell_t} \sum_{i=1}^N N_i I_i \quad (2.11)$$

$$M'_{irr} = \frac{\Delta M \operatorname{sgn}(q) + |\Delta M|}{2(K_{irr} - \alpha|\Delta M|)} \quad (2.12)$$

$$\Delta M = M_{an} - M \quad (2.13)$$

$$M_{an} = \frac{M_s H_e}{A + |H_e|} \quad (2.14)$$

$$q = \text{DELVSCALING} \Delta V \quad (2.15)$$

Xyce dynamically modifies DELVSCALING to be 1000/ Maximum Voltage Drop over the first inductor. This typically produces accurate results for both low voltage and high voltage applicaitons. However, it is possible to use a fixed scaling by setting the model parameter CONSTDELVSCALING to true and then setting DELVSCALING to the desired scaling value.

In Xyce's formulation, we define R as:

$$R = \frac{dH_{app}}{dt} = \frac{1}{\ell_t} \sum_{i=1}^N N_i \frac{dI_i}{dt} \quad (2.16)$$

This simplifies the M equation to:

$$\frac{dM}{dt} = PR \quad (2.17)$$

Xyce then solves for the additional variables M and R when modeling a nonlinear mutual inductor device.

B-H Loop Calculations To calculate B - H loops, H is used as defined above and B is a derived quantity calculated by:

$$B = \mu_0 (H + M) \quad (2.18)$$

$$= \mu_0 \left[H_{app} + \left(1 - \frac{\ell_g}{\ell_t} \right) M \right] \quad (2.19)$$

Converting Nonlinear to Linear Inductor Models At times one may have a model for nonlinear mutual inductor, but wish to use a simpler linear model in a given circuit. To convert a non-linear model to an equivalent linear form, one can start by equating the coupling components of equations 2.3 and 2.4 as:

$$c_{ij} \sqrt{L_i L_j} = \left[1 + \left(1 - \frac{\ell_g}{\ell_t} \right) P(M, I_1 \dots I_N) \right] L_{oij} \quad (2.20)$$

In the above relationship, i and j represent the i th and j th inductors. Since we would like to equate the i th inductor's nonlinear properties to its linear properties, we will substitute $i \rightarrow j$ and simplify assuming steady state where $d/dt = 0$ and $M(t) = 0$.

$$L_i = \frac{1}{c_{ii}} \left\{ 1 + \left(1 - \frac{\ell_g}{\ell_t} \right) \left[\frac{c \frac{Ms}{A}}{1 + \left(\frac{\ell_g}{\ell_t} - \alpha \right) \frac{Ms}{A}} \right] \right\} \frac{\mu A_c}{\ell_t} N_i^2 \quad (2.21)$$

In the above equation, c_{ii} represents the coupling coefficient between the i th inductor with itself. This will likely be 1 unless there are very unusual geometry considerations. Note, that the terms A , Ms , A_c , μ , ℓ_g and ℓ_t all have units of length within them and must use the same unit for this relationship to be valid.

Specifically, μ has units of Henry's per meter and A and Ms have units of Amps per meter. A_c , ℓ_g and ℓ_p have units of length² and length respectively, but the length unit used in the model statement is cm^2 and cm respectively. Thus, one must use consistent units such as meters for A_c , ℓ_g and ℓ_p in equation 2.21 for a valid inductance approximation.

2.3.7. Resistor

Symbol	
Instance Form	R<name> <(+) node> <(-) node> [model name] [value] [device parameters]
Model Form	.MODEL <model name> R [model parameters] .MODEL <model name> RES [model parameters]
Examples	<pre>R1 1 2 2K TEMP=27 RM 4 5 R=4e3 M=2 RSOLDEP 2 0 R={1.0+scalar*V(1)} RLOAD 3 6 RTCMOD 4.540 TEMP=85 .MODEL RTCMOD R (TC1=.01 TC2=-.001) RSEMICON 2 0 RMOD L=1000u W=1u .MODEL RMOD R (RSH=1)</pre>
Parameters and Options	<p>(+) node (-) node Polarity definition for a positive voltage across the resistor. The first node is defined as positive. Therefore, the voltage across the component is the first node voltage minus the second node voltage. Positive current flows from the positive node (first node) to the negative node (second node).</p> <p>model name If [model name] is omitted, then [value] is the resistance in Ohms. If [model name] is given then the resistance is determined from the model parameters; see the resistance value formula below.</p> <p>value Positional specification of device parameter R (resistance). Alternately, this can be specified as a parameter, R=<value>, or in the (optional) model.</p> <p>device parameters Parameters listed in Table 2-42 may be provided as space separated <parameter>=<value> specifications as needed. Any number of parameters may be specified.</p>
Comments	<p>Resistors can have either positive or negative resistance values (R). A zero resistance value (R) is also allowed.</p> <p>The power dissipated in the resistor is calculated with $I \cdot \Delta V$ where the voltage drop is calculated as $(V_+ - V_-)$ and positive current flows from V_+ to V_-. The power accessors (P(C) and W(C)) are supported for both the level 1 resistor and the level 2 (thermal) resistor.</p>

For compatibility with PSpice, either R or RES can be used in a .MODEL statement for a resistor.

The Multiplicity Factor (M) can be used to specify multiple, identical resistors in parallel. The effective resistance becomes R/M . The M value need not be an integer. It can be any positive real number. M can not be used as a model parameter.

Device Parameters

Table 2-42. Resistor Device Instance Parameters

Parameter	Description	Units	Default
DTEMP	Device delta temperature	°C	0
L	Length	m	0
M	Multiplicity Factor	–	1
R	Resistance	Ω	1000
TC1	Linear Temperature Coefficient	°C ⁻¹	0
TC2	Quadratic Temperature Coefficient	°C ⁻²	0
TCE	Exponential Temperature Coefficient	%/°C	0
TEMP	Device temperature	°C	Ambient Temperature
W	Width	m	0

In addition to the parameters shown in the table, the resistor supports a vector parameter for the temperature correction coefficients. TC1=<linear coefficient> and TC2=<quadratic coefficient> may therefore be specified compactly as TC=<linear coefficient>,<quadratic coefficient>.

Model Parameters

Table 2-43. Resistor Device Model Parameters

Parameter	Description	Units	Default
DEFW	Default Instance Width	m	1e-05
NARROW	Narrowing due to side etching	m	0
R	Resistance Multiplier	–	1
RSH	Sheet Resistance	Ω	0
TC1	Linear Temperature Coefficient	°C ⁻¹	0
TC2	Quadratic Temperature Coefficient	°C ⁻²	0
TCE	Exponential Temperature Coefficient	%/°C	0
TNOM	Parameter Measurement Temperature	°C	Ambient Temperature

Note: There is no model parameter for Default Instance Length. The use of the semiconductor resistor model requires the user to specify a non-zero value for the instance parameter L.

Resistor Equations

Resistance Value Formulas If the **R** parameter is given on the device instance line then that value is used.

If the **R** parameter is not given then the semiconductor resistor model will be used if the **L** instance parameter and the **RSH** model parameter are given and both are non-zero. In that case the resistance will be as follows. (Note: If **W** is not given on the instance line then the value for the model parameter **DEFW** will be used instead.)

$$RSH \frac{[L - NARROW]}{[W - NARROW]}$$

If neither of these two cases apply then the default value for the **R** parameter will be used.

Temperature Dependence If **TCE** is specified as either an instance or model parameter for the Level 1 resistor then the resistance at temperature T is given by (where the resistance at the nominal temperature (T_0) was defined above in the resistance value formulas):

$$R \cdot pow(1.01, TCE \cdot (T - T_0))$$

otherwise the resistance is given by:

$$R \cdot (1 + TC1 \cdot (T - T_0) + TC2 \cdot (T - T_0)^2)$$

Thermal (level=2) Resistor Xyce supports a thermal resistor model, which is associated with level=2.

Thermal Resistor Instance Parameters

Table 2-44. Resistor Device Instance Parameters

Parameter	Description	Units	Default
A	Area of conductor	m ²	0
DENSITY	Resistor material density (unused)	kg/m ³	0
HEATCAPACITY	Resistor material volumetric heat capacity	J/(m ³ K)	0
L	Length of conductor	m	0
M	Multiplicity Factor	–	1
OUTPUTINTVARS	Debug Output switch	–	false
R	Resistance	Ω	1000
RESISTIVITY	Resistor material resistivity	Ω m	0
TEMP	Device temperature	°C	Ambient Temperature
THERMAL_A	Area of material thermally coupled to conductor	m ²	0

Table 2-44. Resistor Device Instance Parameters

Parameter	Description	Units	Default
THERMAL_HEATCAPACITY	Volumetric heat capacity of material thermally coupled to conductor	$J/(m^3K)$	0
THERMAL_L	Length of material thermally coupled to conductor	m	0
W	Width of conductor	m	0

Thermal Resistor Model Parameters

Table 2-45. Resistor Device Model Parameters

Parameter	Description	Units	Default
DEFW	Default Instance Width	m	1e-05
DENSITY	Resistor material density (unused)	kg/m^3	0
HEATCAPACITY	Resistor material volumetric heat capacity	$J/(m^3K)$	0
NARROW	Narrowing due to side etching	m	0
R	Resistance Multiplier	–	1
RESISTIVITY	Resistor material resistivity	Ωm	0
RSH	Sheet Resistance	Ω	0
TC1	Linear Temperature Coefficient	$^{\circ}C^{-1}$	0
TC2	Quadratic Temperature Coefficient	$^{\circ}C^{-2}$	0
TCE	Exponential Temperature Coefficient	$\%/^{\circ}C$	0
THERMAL_HEATCAPACITY	Volumetric heat capacity of material thermally coupled to conductor	$J/(m^3K)$	0
TNOM	Nominal device temperature	$^{\circ}C$	Ambient Temperature

The temperature model for the thermal resistor will be enabled if the **A** and **L** instance parameters are given and the parameters **HEATCAPACITY** and **RESISTIVITY** are also given as a pair of either instance parameters or model parameters. Otherwise, the resistance value and temperature dependence of the Level 2 resistor will follow the equations for the Level 1 resistor given above, with the caveat that TCE is only allowed as a model parameter for the Level 2 resistor.

If the temperature model for the Level 2 resistor is enabled, then the resistance (R) is given by the following, where the **RESISTIVITY** can be a temperature-dependent expression:

$$\frac{\mathbf{RESISTIVITY} \cdot \mathbf{L}}{\mathbf{A}}$$

The rate-of-change (dT/dt) of the temperature (T) of the thermal resistor with time is then given by the following where i_0 is the current through the resistor:

$$\frac{i_0 \cdot i_0 \cdot R}{(\mathbf{A} \cdot \mathbf{L} \cdot \mathbf{HEATCAPACITY}) + (\mathbf{THERMAL_A} \cdot \mathbf{THERMAL_L} \cdot \mathbf{THERMAL_HEATCAPACITY})}$$

Solution-Dependent Resistor If the resistance (R) is set equal to an expression then a “solution-dependent” resistor is used, where the resistor is a function of other simulation variables. The formulas for temperature-dependence, given above, then use that calculated R value.

The restrictions for this solution dependent resistors are:

- The expression used for R must only use solution variables, which are node voltages and also branch currents for source devices. It may not use device lead currents, which are post-processed quantities that are not solution variables.
- The expression must not use time derivatives.
- Resistance (R) is the only instance or model parameters that are allowed to be solution-dependent.

2.3.8. Diode

Symbol 

Instance Form D<name> <(+) node> <(-) node> <model name> [area value]

Model Form .MODEL <model name> D [model parameters]

Examples DCLAMP 1 0 DMOD
D2 15 17 SWITCH 1.5

Parameters and Options

(+) node

(-) node

The anode and the cathode.

area value

Scales IS, ISR, IKF, RS, CJO, and IBV, and has a default value of 1. IBV and BV are both specified as positive values.

PJ value

Used in computing the junction sidewall effects, and has a default value of zero (no sidewall effects).

Comments The diode is modeled as an ohmic resistance (RS/area) in series with an intrinsic diode. Positive current is current flowing from the anode through the diode to the cathode.

The power through the diode is calculated with $I \cdot \Delta V$ where the voltage drop is calculated as $(V_+ - V_-)$ and positive current flows from V_+ to V_- . This formula may differ from other simulators, such as HSPICE.

Diode Operating Temperature Model parameters can be assigned unique measurement temperatures using the TNOM model parameter.

Diode level selection Several distinct implementations of the diode are available. These are selected by using the LEVEL model parameter. The default implementation is based on SPICE 3F5, and may be explicitly specified using LEVEL=1 in the model parameters, but is also selected if no LEVEL parameter is specified. The PSpice implementation [2] is obtained by specifying LEVEL=2. The Xyce LEVEL=2000 diode is the JUNCAP200 model. The Xyce LEVEL=2002 diode is the DIODE_CMC model version 2.0.0.

Level 1 and 2 Diode Instance Parameters

Table 2-46. Diode Device Instance Parameters

Parameter	Description	Units	Default
AREA	Area scaling value (scales IS, ISR, IKF, RS, CJO, and IBV)	–	1
DTEMP	Device delta temperature	°C	0
IC		–	0
M	multiplicity factor	–	1
OFF	Initial voltage drop across device set to zero	logical (T/F)	0
PJ	Perimeter scaling value	–	0
TEMP	Device temperature	–	Ambient Temperature

Level 1 and 2 Diode Model Parameters

Table 2-47. Diode Device Model Parameters

Parameter	Description	Units	Default
AF	Flicker noise exponent	–	1
BV	Reverse breakdown "knee" voltage	V	1e+99
CJ	Zero-bias p-n depletion capacitance	F	0
CJ0	Zero-bias p-n depletion capacitance	F	0
CJO	Zero-bias p-n depletion capacitance	F	0
CJP	Sidewall junction capacitance (alias for CJSW)	F	0
CJSW	Sidewall junction capacitance	F	0
EG	Bandgap voltage (barrier height)	eV	1.11
FC	Forward-bias depletion capacitance coefficient	–	0.5
FCS	Forward-bias sidewall depletion capacitance coefficient	–	0.5
IBV	Reverse breakdown "knee" current	A	0.001
IBVL	Low-level reverse breakdown "knee" current	A	0
IKF	High-injection "knee" current	A	0
IS	Saturation current	A	1e-14
ISR	Recombination current parameter	A	0
JS	Saturation current	A	1e-14
JSW	Sidewall Saturation current	A	0
KF	Flicker noise coefficient	–	0
M	Grading parameter for p-n junction	–	0.5

Table 2-47. Diode Device Model Parameters

Parameter	Description	Units	Default
MJSW	Grading parameter for sidewall junction	–	0.33
N	Emission coefficient	–	1
NBV	Reverse breakdown ideality factor	–	1
NBVL	Low-level reverse breakdown ideality factor	–	1
NR	Emission coefficient for ISR	–	2
NS	Sidewall emission coefficient	–	1
PHP	Potential for sidewall junction	V	1
RS	Parasitic resistance	Ω	0
TBV1	BV temperature coefficient (linear)	$^{\circ}\text{C}^{-1}$	0
TBV2	BV temperature coefficient (quadratic)	$^{\circ}\text{C}^{-2}$	0
TIKF	IKF temperature coefficient (linear)	$^{\circ}\text{C}^{-1}$	0
TNOM		–	Ambient Temperature
TRS	RS temperature coefficient (linear) (alias for TRS1)	$^{\circ}\text{C}^{-1}$	0
TRS1	RS temperature coefficient (linear)	$^{\circ}\text{C}^{-1}$	0
TRS2	RS temperature coefficient (quadratic)	$^{\circ}\text{C}^{-2}$	0
TT	Transit time	s	0
VB	Reverse breakdown "knee" voltage	V	1e+99
VJ	Potential for p-n junction	V	1
VJSW	Potential for sidewall junction (alias for PHP)	V	1
XTI	IS temperature exponent	–	3

JUNCAP200 (level=200) Parameters The JUNCAP200 model has the instance and model parameters in the tables below. Complete documentation of JUNCAP200 may be found at http://www.cea.fr/cea-tech/leti/pspsupport/Documents/juncap200p5_summary.pdf.

The JUNCAP200 device supports output of the internal variables in table 2-50 on the .PRINT line of a netlist. To access them from a print line, use the syntax N(<instance>:<variable>) where “<instance>” refers to the name of the specific level 200 D device in your netlist.

Table 2-48. JUNCAP200 Diode Device Instance Parameters

Parameter	Description	Units	Default
AB	Junction area	m^2	1e-12
LG	Gate-edge part of junction perimeter	m^2	1e-06
LS	STI-edge part of junction perimeter	m^2	1e-06
M	Alias for MULT	—	1
MULT	Number of devices in parallel	—	1

Table 2-49. JUNCAP200 Diode Device Model Parameters

Parameter	Description	Units	Default
CBBTBOT	Band-to-band tunneling prefactor of bottom component	A/V^3	1e-12
CBBTGAT	Band-to-band tunneling prefactor of gate-edge component	Am/V^3	1e-18
CBBTSTI	Band-to-band tunneling prefactor of STI-edge component	Am/V^3	1e-18
CJORBOT	Zero-bias capacitance per unit-of-area of bottom component	F/m^2	0.001
CJORGAT	Zero-bias capacitance per unit-of-length of gate-edge component	F/m	1e-09
CJORSTI	Zero-bias capacitance per unit-of-length of STI-edge component	F/m	1e-09
CSRHBOT	Shockley-Read-Hall prefactor of bottom component	A/m^3	100
CSRHGAT	Shockley-Read-Hall prefactor of gate-edge component	A/m^2	0.0001
CSRHSTI	Shockley-Read-Hall prefactor of STI-edge component	A/m^2	0.0001
CTATBOT	Trap-assisted tunneling prefactor of bottom component	A/m^3	100
CTATGAT	Trap-assisted tunneling prefactor of gate-edge component	A/m^2	0.0001
CTATSTI	Trap-assisted tunneling prefactor of STI-edge component	A/m^2	0.0001
DTA	Temperature offset with respect to ambient temperature	K	0
FBBTRBOT	Normalization field at the reference temperature for band-to-band tunneling of bottom component	Vm^{-1}	1e+09
FBBTRGAT	Normalization field at the reference temperature for band-to-band tunneling of gate-edge component	Vm^{-1}	1e+09
FBBTRSTI	Normalization field at the reference temperature for band-to-band tunneling of STI-edge component	Vm^{-1}	1e+09
FJUNQ	Fraction below which junction capacitance components are considered negligible	—	0.03
FREV	Coefficient for reverse breakdown current limitation	—	1000
IDSATRBOT	Saturation current density at the reference temperature of bottom component	A/m^2	1e-12
IDSATRGAT	Saturation current density at the reference temperature of gate-edge component	A/m	1e-18
IDSATRSTI	Saturation current density at the reference temperature of STI-edge component	A/m	1e-18

Table 2-49. JUNCAP200 Diode Device Model Parameters

Parameter	Description	Units	Default
IMAX	Maximum current up to which forward current behaves exponentially	A	1000
LEVEL	Model level must be 200	—	200
MEFFTATBOT	Effective mass (in units of m0) for trap-assisted tunneling of bottom component	—	0.25
MEFFTATGAT	Effective mass (in units of m0) for trap-assisted tunneling of gate-edge component	—	0.25
MEFFTATSTI	Effective mass (in units of m0) for trap-assisted tunneling of STI-edge component	—	0.25
PBOT	Grading coefficient of bottom component	—	0.5
PBRBOT	Breakdown onset tuning parameter of bottom component	V	4
PBRGAT	Breakdown onset tuning parameter of gate-edge component	V	4
PBRSTI	Breakdown onset tuning parameter of STI-edge component	V	4
PGAT	Grading coefficient of gate-edge component	—	0.5
PHIGBOT	Zero-temperature bandgap voltage of bottom component	V	1.16
PHIGGAT	Zero-temperature bandgap voltage of gate-edge component	V	1.16
PHIGSTI	Zero-temperature bandgap voltage of STI-edge component	V	1.16
PSTI	Grading coefficient of STI-edge component	—	0.5
STFBBTBOT	Temperature scaling parameter for band-to-band tunneling of bottom component	1/K	-0.001
STFBBTGAT	Temperature scaling parameter for band-to-band tunneling of gate-edge component	1/K	-0.001
STFBBTSTI	Temperature scaling parameter for band-to-band tunneling of STI-edge component	1/K	-0.001
SWJUNEXP	Flag for JUNCAP-express; 0=full model, 1=express model	—	0
TRJ	Reference temperature	°C	21
TYPE	Type parameter, in output value 1 reflects n-type, -1 reflects p-type	—	1
VBIRBOT	Built-in voltage at the reference temperature of bottom component	V	1
VBIRGAT	Built-in voltage at the reference temperature of gate-edge component	V	1
VBIRSTI	Built-in voltage at the reference temperature of STI-edge component	V	1

Table 2-49. JUNCAP200 Diode Device Model Parameters

Parameter	Description	Units	Default
VBRBOT	Breakdown voltage of bottom component	V	10
VBRGAT	Breakdown voltage of gate-edge component	V	10
VBRSTI	Breakdown voltage of STI-edge component	V	10
VJUNREF	Typical maximum junction voltage; usually about 2*VSUP	V	2.5
XJUNGAT	Junction depth of gate-edge component	m	1e-07
XJUNSTI	Junction depth of STI-edge component	m	1e-07

Table 2-50. Diode level 200 Output Variables

Parameter	Description	Units	Default
vak	Voltage between anode and cathode	V	none
cj	Total source junction capacitance	F	none
cjbot	Junction capacitance (bottom component)	F	none
cjgat	Junction capacitance (gate-edge component)	F	none
cjsti	Junction capacitance (STI-edge component)	F	none
ij	Total source junction current	A	none
ijbot	Junction current (bottom component)	A	none
ijgat	Junction current (gate-edge component)	A	none
ijsti	Junction current (STI-edge component)	A	none
si	Total junction current noise spectral density	A ² /Hz	none
idsatsbot	Total bottom saturation current	A	none
idsatssti	Total STI-edge saturation current	A	none
idsatsgat	Total gate-edge saturation current	A	none
cjosbot	Total bottom capacity	F	none
cjossti	Total STI-edge capacity	F	none
cjosgat	Total gate-edge capacity	F	none
vbisbot	built-in voltage of the bottom junction	V	none
vbissti	built-in voltage of the STI-edge junction	V	none
vbisgat	built-in voltage of the gate-edge junction	V	none

DIODE_CMC (level=2002) Parameters The DIODE_CMC model has the instance and model parameters in the tables below. Complete documentation of DIODE_CMC may be found at <https://si2.org/standard-models>.

The DIODE_CMC device supports output of the internal variables in table 2-53 on the .PRINT line of a netlist. To access them from a print line, use the syntax N(<instance>:<variable>) where “<instance>” refers to the name of the specific level 2002 D device in your netlist.

Table 2-51. DIODE_CMC 2.0.0 Device Instance Parameters

Parameter	Description	Units	Default
AB	Junction area	m ²	1e-12
AREA	Alias for AB	m ²	1e-12
LG	Gate-edge part of junction perimeter	m	0
LS	STI-edge part of junction perimeter	m	1e-06
MULT	Number of devices in parallel	—	1
PERIM	Alias for LS	m	1e-06
PJ	Alias for LS	m	1e-06

Table 2-52. DIODE_CMC 2.0.0 Device Model Parameters

Parameter	Description	Units	Default
ABMAX	maximum allowed junction area	m ²	1
ABMIN	minimum allowed junction area	m ²	0
AF	AF parameter for flicker noise	—	1
CBBTBOT	Band-to-band tunneling prefactor of bottom component	A/V ³	1e-12
CBBTGAT	Band-to-band tunneling prefactor of gate-edge component	Am/V ³	1e-18
CBBTSTI	Band-to-band tunneling prefactor of STI-edge component	Am/V ³	1e-18
CJORBOT	Zero-bias capacitance per unit-of-area of bottom component	F/m ²	0.001
CJORGAT	Zero-bias capacitance per unit-of-length of gate-edge component	F/m	1e-09
CJORSTI	Zero-bias capacitance per unit-of-length of STI-edge component	F/m	1e-09
CORECOVERY	Flag for recovery equations; 0=original, 1=Hiroshima	—	0
CSRHBOT	Shockley-Read-Hall prefactor of bottom component	A/m ³	100
CSRHGAT	Shockley-Read-Hall prefactor of gate-edge component	A/m ²	0.0001
CSRHSTI	Shockley-Read-Hall prefactor of STI-edge component	A/m ²	0.0001
CTATBOT	Trap-assisted tunneling prefactor of bottom component	A/m ³	100
CTATGAT	Trap-assisted tunneling prefactor of gate-edge component	A/m ²	0.0001
CTATSTI	Trap-assisted tunneling prefactor of STI-edge component	A/m ²	0.0001
DEPNQS	Depletion delay time	—	0
DTA	Temperature offset with respect to ambient temperature	C	0

Table 2-52. DIODE_CMC 2.0.0 Device Model Parameters

Parameter	Description	Units	Default
FBBTB BOT	Normalization field at the reference temperature for band-to-band tunneling of bottom component	Vm^{-1}	1e+09
FBBTG AT	Normalization field at the reference temperature for band-to-band tunneling of gate-edge component	Vm^{-1}	1e+09
FBBTSTI	Normalization field at the reference temperature for band-to-band tunneling of STI-edge component	Vm^{-1}	1e+09
FJUNQ	Fraction below which junction capacitance components are considered negligible	—	0.03
FREV	Additional parameter for current after breakdown	—	1000
IDSATB BOT	Saturation current density at the reference temperature of bottom component	A/m^2	1e-12
IDSATG AT	Saturation current density at the reference temperature of gate-edge component	A/m	1e-18
IDSATSTI	Saturation current density at the reference temperature of STI-edge component	A/m	1e-18
IMAX	Maximum current up to which forward current behaves exponentially	A	1000
INJ1	For carrier density	—	1
INJ2	For carrier density in high-injection condition	—	10
INJT	Temp. co of carrier density in high-injection condition	—	0
KF	KF parameter for flicker noise	—	0
LGMAX	maximum allowed junction gate-edge	m	1
LGMIN	minimum allowed junction gate-edge	m	0
LSMAX	maximum allowed junction STI-edge	m	1
LSMIN	minimum allowed junction STI-edge	m	0
MEFFTATB OT	Effective mass (in units of m_0) for trap-assisted tunneling of bottom component	—	0.25
MEFFTATG AT	Effective mass (in units of m_0) for trap-assisted tunneling of gate-edge component	—	0.25
MEFFTATSTI	Effective mass (in units of m_0) for trap-assisted tunneling of STI-edge component	—	0.25
NDIBOT	Doping concentration of drift region	—	1e+16
NDIGAT	Doping concentration of drift region	—	1e+16
NDISTI	Doping concentration of drift region	—	1e+16
NFABOT	ideality factor bottom component	—	1
NFAGAT	ideality factor gate-edge component	—	1
NFASTI	ideality factor STI-edge component	—	1
NJDV	Transition slope of emission coefficient	—	0.1
NJH	High-injection emission coefficient	—	1

Table 2-52. DIODE_CMC 2.0.0 Device Model Parameters

Parameter	Description	Units	Default
NQS	Carrier delay time	—	5e-09
PBOT	Grading coefficient of bottom component	—	0.5
PBRBOT	Breakdown onset tuning parameter of bottom component	V	4
PBRGAT	Breakdown onset tuning parameter of gate-edge component	V	4
PBRSTI	Breakdown onset tuning parameter of STI-edge component	V	4
PGAT	Grading coefficient of gate-edge component	—	0.5
PHIGBOT	Zero-temperature bandgap voltage of bottom component	V	1.16
PHIGGAT	Zero-temperature bandgap voltage of gate-edge component	V	1.16
PHIGSTI	Zero-temperature bandgap voltage of STI-edge component	V	1.16
PSTI	Grading coefficient of STI-edge component	—	0.5
PT	Alias for XTI	—	3
REVISION	Model revision	—	0
RSBOT	Series resistance per unit-of-area of bottom component	—	0
RSCOM	Common series resistance, no scaling	—	0
RSGAT	Series resistance per unit-of-length of gate-edge component	—	0
RSSTI	Series resistance per unit-of-length of STI-edge component	—	0
SCALE	Scale parameter	—	1
SHRINK	Scale parameter	—	0
STFBBTBOT	Temperature scaling parameter for band-to-band tunneling of bottom component	1/K	-0.001
STFBBTGAT	Temperature scaling parameter for band-to-band tunneling of gate-edge component	1/K	-0.001
STFBBTSTI	Temperature scaling parameter for band-to-band tunneling of STI-edge component	1/K	-0.001
STRS	Temperature scaling parameter for series resistance	—	0
STVBRBOT1	Temp. co of breakdown voltage bottom component	1/K	0
STVBRBOT2	Temp. co of breakdown voltage bottom component	—	0
STVBRGAT1	Temp. co of breakdown voltage gate-edge component	1/K	0
STVBRGAT2	Temp. co of breakdown voltage gate-edge component	—	0
STVBRSTI1	Temp. co of breakdown voltage STI-edge component	1/K	0

Table 2-52. DIODE_CMC 2.0.0 Device Model Parameters

Parameter	Description	Units	Default
STVBRSTI2	Temp. co of breakdown voltage STI-edge component	—	0
SUBVERSION	Model subversion	—	0
SWJUNEXP	Flag for JUNCAP-express; 0=full model, 1=express model	—	0
TAU	Carrier lifetime	—	2e-07
TAUT	Temp. co of carrier lifetime	—	0
TEMPMAX	maximum allowed junction temp	C	155
TEMPMIN	minimum allowed junction temp	C	-55
TNOM	Alias reference temperature	C	21
TRJ	Reference temperature	C	21
TT	Transit time	s	0
TYPE	Type parameter, in output value 1 reflects n-type, -1 reflects p-type	—	1
VBIRBOT	Built-in voltage at the reference temperature of bottom component	V	1
VBIRGAT	Built-in voltage at the reference temperature of gate-edge component	V	1
VBIRSTI	Built-in voltage at the reference temperature of STI-edge component	V	1
VBRBOT	Breakdown voltage of bottom component	V	10
VBRGAT	Breakdown voltage of gate-edge component	V	10
VBRSTI	Breakdown voltage of STI-edge component	V	10
VERSION	Model version	—	2
VFMAX	maximum allowed forward junction bias	V	0
VJUNREF	Typical maximum junction voltage; usually about 2*VSUP	—	2.5
VRMAX	maximum allowed reverse junction bias	V	0
WI	Length of drift region	m	5e-06
XJUNGAT	Junction depth of gate-edge component	m	1e-07
XJUNSTI	Junction depth of STI-edge component	m	1e-07
XTI	Temp. co of saturation current	—	3

Table 2-53. Diode level 2002 Output Variables

Parameter	Description	Units	Default
vak	Voltage between anode and cathode excluding the series resistor	V	none
cj	Total source junction capacitance	F	none

Table 2-53. Diode level 2002 Output Variables

Parameter	Description	Units	Default
cjbot	Junction capacitance (bottom component)	F	none
cjgat	Junction capacitance (gate-edge component)	F	none
cjsti	Junction capacitance (STI-edge component)	F	none
ij	Total source junction current	A	none
ijbot	Junction current (bottom component)	A	none
ijgat	Junction current (gate-edge component)	A	none
ijsti	Junction current (STI-edge component)	A	none
si	Total junction current noise spectral density	A ² /Hz	none
vrs	Voltage across series resistor	V	none
sf	Total junction flicker noise spectral density	A ² /Hz	none
sr	Total series resistor thermal noise spectral density	A ² /Hz	none
rseries	Series resistor	V/A	none
qrr	Recovery charge	C	none

Level 1 Diode Equations The equations in this section use the following variables:

$$\begin{aligned}
 V_{di} &= \text{voltage across the intrinsic diode only} \\
 V_{th} &= k \cdot T/q \text{ (thermal voltage)} \\
 k &= \text{Boltzmann's constant} \\
 q &= \text{electron charge} \\
 T &= \text{analysis temperature (Kelvin)} \\
 T_0 &= \text{nominal temperature (set using **TNOM** option)} \\
 \omega &= \text{Frequency (Hz)}
 \end{aligned}$$

Other variables are listed above in the diode model parameters.

Level=1 The level 1 diode is based on the Spice3f5 level 1 model.

DC Current (Level=1) The intrinsic diode current consists of forward and reverse bias regions where

$$I_D = \begin{cases} \mathbf{IS} \cdot \left[\exp\left(\frac{V_{di}}{\mathbf{NV}_{th}}\right) - 1 \right], & V_{di} > -3.0 \cdot \mathbf{NV}_{th} \\ -\mathbf{IS} \cdot \left[1.0 + \left(\frac{3.0 \cdot \mathbf{NV}_{th}}{V_{di} \cdot e}\right)^3 \right], & V_{di} < -3.0 \cdot \mathbf{NV}_{th} \end{cases}$$

When **BV** and an optional parameter **IBV** are explicitly given in the model statement, an exponential model is used to model reverse breakdown (with a “knee” current of **IBV** at a “knee-on” voltage of **BV**). The equation for I_D implemented by Xyce is given by

$$I_D = -\mathbf{IBV}_{\text{eff}} \cdot \exp\left(-\frac{\mathbf{BV}_{\text{eff}} + V_{di}}{\mathbf{NV}_{th}}\right), \quad V_{di} \leq \mathbf{BV}_{\text{eff}},$$

where \mathbf{BV}_{eff} and $\mathbf{IBV}_{\text{eff}}$ are chosen to satisfy the following constraints:

1. Continuity of I_D between reverse bias and reverse breakdown regions (i.e., continuity of I_D at $V_{di} = -\mathbf{BV}_{\text{eff}}$):

$$\mathbf{IBV}_{\text{eff}} = \mathbf{IS} \left(1 - \left(\frac{3.0 \cdot \mathbf{NV}_{th}}{e \cdot \mathbf{BV}_{\text{eff}}} \right)^3 \right)$$

2. “Knee-on” voltage/current matching:

$$\mathbf{IBV}_{\text{eff}} \cdot \exp\left(-\frac{\mathbf{BV}_{\text{eff}} - \mathbf{BV}}{\mathbf{NV}_{th}}\right) = \mathbf{IBV}$$

Substituting the first expression into the second yields a single constraint on \mathbf{BV}_{eff} which cannot be solved for directly. By performing some basic algebraic manipulation and rearranging terms, the problem of finding \mathbf{BV}_{eff} which satisfies the above two constraints can be cast as finding the (unique) solution of the equation

$$\mathbf{BV}_{\text{eff}} = f(\mathbf{BV}_{\text{eff}}), \quad (2.22)$$

where $f(\cdot)$ is the function that is obtained by solving for the \mathbf{BV}_{eff} term which appears in the exponential in terms of \mathbf{BV}_{eff} and the other parameters. Xyce solves Eqn. 2.22 by performing the so-called *Picard Iteration* procedure [11], i.e. by producing successive estimates of \mathbf{BV}_{eff} (which we will denote as $\mathbf{BV}_{\text{eff}}^k$) according to

$$\mathbf{BV}_{\text{eff}}^{k+1} = f(\mathbf{BV}_{\text{eff}}^k)$$

starting with an initial guess of $\mathbf{BV}_{\text{eff}}^0 = \mathbf{BV}$. The current iteration procedure implemented in Xyce can be shown to guarantee at least six significant digits of accuracy between the numerical estimate of \mathbf{BV}_{eff} and the true value.

In addition to the above, Xyce also requires that \mathbf{BV}_{eff} lie in the range $\mathbf{BV} \geq \mathbf{BV}_{\text{eff}} \geq 3.0\mathbf{NV}_{th}$. In terms of \mathbf{IBV} , this is equivalent to enforcing the following two constraints:

$$\mathbf{IS} \left(1 - \left(\frac{3.0 \cdot \mathbf{NV}_{th}}{e \cdot \mathbf{BV}} \right)^3 \right) \leq \mathbf{IBV} \quad (2.23)$$

$$\mathbf{IS} \left(1 - e^{-3} \right) \exp\left(\frac{-3.0 \cdot \mathbf{NV}_{th} + \mathbf{BV}}{\mathbf{NV}_{th}}\right) \geq \mathbf{IBV} \quad (2.24)$$

Xyce first checks the value of \mathbf{IBV} to ensure that the above two constraints are satisfied. If Eqn. 2.23 is violated, Xyce sets $\mathbf{IBV}_{\text{eff}}$ to be equal to the left-hand side of Eqn. 2.23 and, correspondingly, sets \mathbf{BV}_{eff} to $-3.0 \cdot \mathbf{NV}_{th}$. If Eqn. 2.24 is violated, Xyce sets $\mathbf{IBV}_{\text{eff}}$ to be equal to the left-hand side of Eqn. 2.24 and, correspondingly, sets \mathbf{BV}_{eff} to \mathbf{BV} .

Capacitance (Level=1) The p-n diode capacitance consists of a depletion layer capacitance C_d and a diffusion capacitance C_{dif} . The first is given by

$$C_d = \begin{cases} \mathbf{CJ} \cdot \mathbf{AREA} \left(1 - \frac{V_{di}}{\mathbf{VJ}}\right)^{-M}, & V_{di} \leq \mathbf{FC} \cdot \mathbf{VJ} \\ \frac{\mathbf{CJ} \cdot \mathbf{AREA}}{\mathbf{F2}} \left(\mathbf{F3} + \mathbf{M} \frac{V_{di}}{\mathbf{VJ}}\right), & V_{di} > \mathbf{FC} \cdot \mathbf{VJ} \end{cases}$$

The diffusion capacitance (sometimes referred to as the transit time capacitance) is

$$C_{dif} = \mathbf{TT} G_d = \mathbf{TT} \frac{dI_D}{dV_{di}}$$

where G_d is the junction conductance.

Sidewall currents and capacitances When the instance parameter PJ (perimeter scaling value) is specified, the diode currents become the sum of the currents above (the “bottom” of the junction) and those of the periphery (sidewall).

In normal forward and reverse bias regions, the sidewall currents are given by:

$$I_{D,sw} = \begin{cases} \mathbf{ISatSW} \cdot \left[\exp\left(\frac{V_{di}}{\mathbf{NSV}_{th}}\right) - 1 \right], & V_{di} > -3.0 \cdot \mathbf{NSV}_{th} \\ -\mathbf{ISatSW} \cdot \left[1.0 + \left(\frac{3.0 \cdot \mathbf{NSV}_{th}}{V_{di} \cdot e}\right)^3 \right], & V_{di} < -3.0 \cdot \mathbf{NSV}_{th} \end{cases}$$

where \mathbf{ISatSW} is the temperature-adjusted value of JSW multiplied by the perimeter \mathbf{PJ} .

When the breakdown voltage \mathbf{BV} has been given and the diode voltage is below $-\mathbf{BV}$, the sidewall current is:

$$I_{D,sw} = -\mathbf{ISatSW} \cdot \exp\left(-\frac{\mathbf{BVe}ff + V_{di}}{\mathbf{NSV}_{th}}\right), \quad V_{di} \leq \mathbf{BVe}ff,$$

The sidewall capacitances are computed as:

$$C_{d,sw} = \begin{cases} \mathbf{CJSW} \cdot \mathbf{PJ} \left(1 - \frac{V_{di}}{\mathbf{PHP}}\right)^{-M}, & V_{di} \leq \mathbf{FCS} \cdot \mathbf{PHP} \\ \frac{\mathbf{CJSW} \cdot \mathbf{PJ}}{\mathbf{F2SW}} \left(\mathbf{F3SW} + \mathbf{MJ} \frac{V_{di}}{\mathbf{PHP}}\right), & V_{di} > \mathbf{FCS} \cdot \mathbf{PHP} \end{cases}$$

Temperature Effects (Level=1) The diode model contains explicit temperature dependencies in the ideal diode current, the generation/recombination current and the breakdown current. Further temperature dependencies are present in the diode model via the saturation current I_S , the depletion layer junction

capacitance CJ , the junction potential V_J .

$$\begin{aligned}
V_t(T) &= \frac{kT}{q} \\
V_{tnom}(T) &= \frac{k\mathbf{TNOM}}{q} \\
E_g(T) &= E_{g0} - \frac{\alpha T^2}{\beta + T} \\
E_{gNOM}(T) &= E_{g0} - \frac{\alpha \mathbf{TNOM}^2}{\mathbf{TNOM} + \beta} \\
arg1(T) &= -\frac{E_g(T)}{2kT} + \frac{E_{g300}}{2kT_0} \\
arg2(T) &= -\frac{E_{gNOM}(T)}{2k\mathbf{TNOM}} + \frac{E_{g300}}{2kT_0} \\
pbfact1(T) &= -2.0 \cdot V_t(T) \left(1.5 \cdot \ln\left(\frac{T}{T_0}\right) + q \cdot arg1(T) \right) \\
pbfact2(T) &= -2.0 \cdot V_{tnom}(T) \left(1.5 \cdot \ln\left(\frac{\mathbf{TNOM}}{T_0}\right) + q \cdot arg2(T) \right) \\
pbo(T) &= (\mathbf{VJ} - pbfact2(T)) \frac{T_0}{\mathbf{TNOM}} \\
V_J(T) &= pbfact1(T) + \frac{T}{T_0} pbo(T) \\
gma_{old}(T) &= \frac{\mathbf{VJ} - pbo(T)}{pbo(T)} \\
gma_{new}(T) &= \frac{V_J(T) - pbo(T)}{pbo(T)} \\
CJ(T) &= \mathbf{CJ0} \frac{1.0 + \mathbf{M} (4.0 \times 10^{-4} (T - T_0) - gma_{new}(T))}{1.0 + \mathbf{M} (4.0 \times 10^{-4} (\mathbf{TNOM} - T_0) - gma_{old}(T))} \\
I_S(T) &= \mathbf{IS} \cdot \exp\left(\left(\frac{T}{\mathbf{TNOM}} - 1.0\right) \cdot \frac{\mathbf{EG}}{\mathbf{NV}_t(T)} + \frac{\mathbf{XTI}}{\mathbf{N}} \cdot \ln\left(\frac{T}{\mathbf{TNOM}}\right)\right)
\end{aligned}$$

where, for silicon, $\alpha = 7.02 \times 10^{-4} \text{ eV/K}$, $\beta = 1108 \text{ K}$ and $E_{g0} = 1.16 \text{ eV}$.

For a more thorough description of p-n junction physics, see [9]. For a thorough description of the U.C. Berkeley SPICE models see Reference [11].

2.3.9. Independent Current Source



Symbol

Instance Form I<name> <(+) node> <(-) node> [[DC] <value>]
 + [AC [magnitude value [phase value]]] [transient specification]

Examples ISLOW 1 22 SIN(0.5 1.0ma 1KHz 1ms)
 IPULSE 1 3 PULSE(-1 1 2ns 2ns 2ns 50ns 100ns)
 IPAT 2 4 PAT(5 0 0 1n 2n 5n b0101)

Parameters and Options

transient specification

There are five predefined time-varying functions for sources:

- PULSE <parameters> Pulse waveform
 - SIN <parameters> Sinusoidal waveform
 - EXP <parameters> Exponential waveform
 - PAT <parameters> Pattern waveform
 - PWL <parameters> Piecewise linear waveform
 - SFFM <parameters> Frequency-modulated waveform
-

Comments Positive current flows from the positive node through the source to the negative node.

The power supplied or dissipated by the current source is calculated with $I \cdot \Delta V$ where the voltage drop is calculated as $(V_+ - V_-)$ and positive current flows from V_+ to V_- . Dissipated power has a positive sign, while supplied power has a negative sign.

The default value is zero for the DC, AC, and transient values. None, any, or all of the DC, AC, and transient values can be specified. The AC phase value is in degrees.

Transient Specifications This section outlines the available transient specifications. Δt and T_F are the time step size and simulation end-time, respectively. Parameters marked as – must have a value specified for them; otherwise a netlist parsing error will occur.

Pulse

PULSE(V1 V2 TD TR TF PW PER)

Table 2-54. Pulse Parameters

Parameter	Description	Units	Default
V1	Initial Value	amp	–
V2	Pulse Value	amp	0.0
TD	Delay Time	s	0.0
TR	Rise Time	s	Δt
TF	Fall Time	s	Δt
PW	Pulse Width	s	T_F
PER	Period	s	T_F

Sine

SIN(V0 VA FREQ TD THETA PHASE)

Table 2-55. Sine Parameters

Parameter	Description	Units	Default
V0	Offset	amp	–
VA	Amplitude	amp	–
FREQ	Frequency	s^{-1}	–
TD	Delay	s	Δt
THETA	Attenuation Factor	s	Δt
PHASE	Phase	degrees	0.0

The waveform is shaped according to the following equations, where $\phi = \pi * \mathbf{PHASE}/180$:

$$I = \begin{cases} V_0, & 0 < t < T_D \\ V_0 + V_A \sin[2\pi \cdot \mathbf{FREQ} \cdot (t - T_D) + \phi] \exp[-(t - T_D) \cdot \mathbf{THETA}], & T_D < t < T_F \end{cases}$$

Exponent

EXP(V1 V2 TD1 TAU1 TD2 TAU2)

Table 2-56. Exponent Parameters

Parameter	Description	Units	Default
V1	Initial Amplitude	amp	–
V2	Amplitude	amp	–
TD1	Rise Delay Time	s	0.0
TAU1	Rise Time Constant	s	Δt

Table 2-56. Exponent Parameters

Parameter	Description	Units	Default
TD2	Delay Fall Time	s	TD1 + Δt
TAU2	Fall Time Constant	s	Δt

The waveform is shaped according to the following equations:

$$I = \begin{cases} V_1, & 0 < t < TD1 \\ V_1 + (V_2 - V_1)\{1 - \exp[-(t - TD1)/TAU1]\}, & TD1 < t < TD2 \\ V_1 + (V_2 - V_1)\{1 - \exp[-(t - TD1)/TAU1]\} \\ \quad + (V_1 - V_2)\{1 - \exp[-(t - TD2)/TAU2]\}, & TD2 < t < T_2 \end{cases}$$

Pattern

PAT(VHI VLO TD TR TF TSAMPLE DATA R)

Table 2-57. Pattern Parameters

Parameter	Description	Units	Default
VHI	High Value	amp	–
VLO	Low Value	amp	–
TD	Delay Time	s	–
TR	Rise Time	s	–
TF	Fall Time	s	–
TSAMPLE	Bit period	s	–
DATA	Bit pattern	–	–
R	Repeat	–	0

The VHI, VLO, TD, TF, TF TSAMPLE and DATA parameters are all required, and hence have no default values. Negative values for TD are supported. The R parameter is optional. For its default value of 0, the requested bit pattern will occur once.

The DATA parameter is the requested bit-pattern. Only the 0' and '1' states are supported. The 'M' and 'Z' states are not supported. The DATA field should have a leading 'b' (or 'B') character (e.g., be specified as 'b0101').

For times earlier than TD, the waveform value is set by the first bit in DATA. For times after the end of the (possibly repeated) pattern, the waveform value is set by the last bit in DATA. Piecewise linear interpolation is used to generate the output value when transitioning between states.

The VHI, VLO, TD, TF, TF and TSAMPLE parameters are compatible with .STEP. The DATA and R parameters are not.

The HSPICE parameters RB, ENCODE and RD_INIT, for the pattern source, are not supported.

Piecewise Linear

PWL T0 V0 [Tn Vn]*

PWL FILE "<name>" [TD=<timeDelay>] [R=<repeatTime>]

Table 2-58. Piecewise Linear Parameters

Parameter	Description	Units	Default
T_n	Time at Corner	s	none
V_n	Current at Corner	amp	none
TD	Time Delay	s	0
R	Repeat Time	s	none

When the FILE option is given, Xyce will read the corner points from the file specified in the <name> field. This file should be a plain ASCII text file (or a .CSV file) with the time/current pairs. There should be one pair per line, and the time and current values should be separated by whitespace or commas. As an example, the file specified (e.g., ipwl.csv) could have these five lines:

```
0.00, 0.00
2.00, 3.00
3.00, 2.00
4.00, 2.00
4.01, 5.00
```

The corresponding example instance lines would be:

```
IPWL1 1 0 PWL 0S 0A 2S 3A 3S 2A 4S 2A 4.01S 5A
IPWL2 2 0 PWL FILE "ipwl.txt"
IPWL3 3 0 PWL file "ipwl.csv"
IPWL4 4 0 PWL FILE ipwl.csv
```

The double quotes around the file name are optional, as shown above.

It is a best practice to specify all of the time-current pairs in the PWL specification. However, for compatibility with HSPICE and PSpice, if the user-specified list of time/current pairs omits the pair at time=0 as the first pair in the list then Xyce will insert a pair at time=0 with the current value at the first user-specified time value. As an example, this user-specified list:

```
2S 3A 3S 2A 4S 2A 4.01S 5A
```

would be implemented in Xyce as follows:

```
0S 3A 2S 3A 3S 2A 4S 2A 4.01S 5A
```

TD has units of seconds, and specifies the length of time to delay the start of PWL waveform. The default is to have no delay, and TD is an optional parameter.

The Repeat Time (R) is an optional parameter. If R is omitted then the waveform will not repeat. If R is included then the waveform will repeat until the end of the simulation. As examples, R=0 means repeat the PWL waveform from time=0 to the last time (T_N) specified in the waveform specification. (This would use the time points 0s, 2s, 3s, 4s and 4.01s for the example waveform given above.) In general, R=<repeatTime> means repeat the waveform from time equal to <repeatTime> seconds in the waveform specification to the last time (T_N) specified in the waveform specification. So, the <repeatTime> must be greater than or equal to 0 and less than the last time point (T_N). If the R parameter is used then it must have a value.

The specification PWL FILE "<name>" R is illegal in Xyce as a shorthand for R=0. Also, the Xyce syntax for PWL sources is not compatible with the PSpice REPEAT syntax for PWL sources. See section 6.1.12 for more details.

The repeat time (R) does enable the specification of discontinuous piecewise linear waveforms. For example, this waveform is a legal Xyce syntax.

```
IPWL1 1 0 PWL 0S 0A 2S 3A 3S 2A 4S 2A 4.01S 5A R=2
```

However, in general, discontinuous source waveforms may cause convergence problems.

Frequency Modulated

```
SFFM (V0 VA FC MDI FS)
```

Table 2-59. Frequency Modulated Parameters

Parameter	Description	Units	Default
V0	Offset	amp	-
VA	Amplitude	amp	-
FC	Carrier Frequency	hertz	1/TSTOP
MDI	Modulation Index	-	0
FS	Signal Frequency	hertz	1/TSTOP

TSTOP is the final time, as entered into the transient (.TRANS) command. The waveform is shaped according to the following equation:

$$I = V_0 + V_A \cdot \sin(2\pi \cdot FC \cdot \mathbf{TIME} + MDI \cdot \sin(2\pi \cdot FS \cdot \mathbf{TIME}))$$

where **TIME** is the current simulation time.

2.3.10. Independent Voltage Source



Symbol

Instance Form V<name> <(+) node> <(-) node> [[DC] <value>]
 + [AC [magnitude value [phase value]]] [transient specification]

Examples VSLOW 1 22 SIN(0.5 1.0mV 1KHz 1ms)
 VPULSE 1 3 PULSE(-1 1 2ns 2ns 2ns 50ns 100ns)
 VPAT 2 4 PAT(5 0 0 1n 2n 5n b0101)

Parameters and Options

transient specification

There are five predefined time-varying functions for sources:

PULSE <parameters> Pulse waveform

SIN <parameters> Sinusoidal waveform

EXP <parameters> Exponential waveform

PAT <parameters> Pattern waveform

PWL <parameters> Piecewise linear waveform

SFFM <parameters> Frequency-modulated waveform

Comments Positive current flows from the positive node through the source to the negative node.

The power supplied or dissipated by the voltage source is calculated with $I \cdot \Delta V$ where the voltage drop is calculated as $(V_+ - V_-)$ and positive current flows from V_+ to V_- . Dissipated power has a positive sign, while supplied power has a negative sign.

None, any, or all of the DC, AC, and transient values can be specified. The AC phase value is in degrees.

Transient Specifications This section outlines the available transient specifications. Δt and T_F are the time step size and simulation end-time, respectively. Parameters marked as – must have a value specified for them; otherwise a netlist parsing error will occur.

Pulse

PULSE(V1 V2 TD TR TF PW PER)

Table 2-60. Pulse Parameters

Parameter	Description	Units	Default
V1	Initial Value	Volt	–
V2	Pulse Value	Volt	0.0
TD	Delay Time	s	0.0
TR	Rise Time	s	Δt
TF	Fall Time	s	Δt
PW	Pulse Width	s	T_F
PER	Period	s	T_F

Sine

SIN(V0 VA FREQ TD THETA PHASE)

Table 2-61. Sine Parameters

Parameter	Description	Units	Default
V0	Offset	Volt	–
VA	Amplitude	Volt	–
FREQ	Frequency	s^{-1}	–
TD	Delay	s	Δt
THETA	Attenuation Factor	s	Δt
PHASE	Phase	degrees	0.0

The waveform is shaped according to the following equations, where $\phi = \pi * \mathbf{PHASE}/180$:

$$V = \begin{cases} V_0, & 0 < t < T_D \\ V_0 + V_A \sin[2\pi \cdot \mathbf{FREQ} \cdot (t - T_D) + \phi] \exp[-(t - T_D) \cdot \mathbf{THETA}], & T_D < t < T_F \end{cases}$$

Exponent

EXP(V1 V2 TD1 TAU1 TD2 TAU2)

Table 2-62. Exponent Parameters

Parameter	Description	Units	Default
V1	Initial Amplitude	Volt	–
V2	Amplitude	Volt	–
TD1	Rise Delay Time	s	0.0
TAU1	Rise Time Constant	s	Δt

Table 2-62. Exponent Parameters

Parameter	Description	Units	Default
TD2	Delay Fall Time	s	TD1 + Δt
TAU2	Fall Time Constant	s	Δt

The waveform is shaped according to the following equations:

$$V = \begin{cases} V_1, & 0 < t < TD1 \\ V_1 + (V_2 - V_1)\{1 - \exp[-(t - TD1)/TAU1]\}, & TD1 < t < TD2 \\ V_1 + (V_2 - V_1)\{1 - \exp[-(t - TD1)/TAU1]\} \\ \quad + (V_1 - V_2)\{1 - \exp[-(t - TD2)/TAU2]\}, & TD2 < t < T_2 \end{cases}$$

Pattern

PAT(VHI VLO TD TR TF TSAMPLE DATA R)

Table 2-63. Pattern Parameters

Parameter	Description	Units	Default
VHI	High Value	Volt	–
VLO	Low Value	Volt	–
TD	Delay Time	s	–
TR	Rise Time	s	–
TF	Fall Time	s	–
TSAMPLE	Bit period	s	–
DATA	Bit pattern	–	–
R	Repeat	–	0

The VHI, VLO, TD, TR, TF, TSAMPLE and DATA parameters are all required, and hence have no default values. Negative values for TD are supported. The R parameter is optional. For its default value of 0, the requested bit pattern will occur once.

The DATA parameter is the requested bit-pattern. Only the 0' and '1' states are supported. The 'M' and 'Z' states are not supported. The DATA field should have a leading 'b' (or 'B') character (e.g., be specified as 'b0101').

For times earlier than TD, the waveform value is set by the first bit in DATA. For times after the end of the (possibly repeated) pattern, the waveform value is set by the last bit in DATA. Piecewise linear interpolation is used to generate the output value when transitioning between states.

The relationship between the various source parameters can be illustrated with the following example:

V1 1 0 PAT(5 0 0 1n 1n 5n b010)

That V1 source definition would produce time-voltages pairs at (0 0) (4.5ns 0) (5ns 2.5) (5.5ns 5.0) (9.5ns 5.0) (10ns 2.5) (10.5ns 0). So, the bit period is 5ns and the voltage value at the start/end of each "sample" is

equal to $0.5 \cdot (V_{HI} + V_{LO})$. The first rise is centered around $t=5\text{ns}$, and hence starts at $t=4.5\text{ns}$ and ends at $t=5.5\text{ ns}$.

The VHI, VLO, TD, TF, TF and TSAMPLE parameters are compatible with .STEP. The DATA and R parameters are not.

The HSPICE parameters RB, ENCODE and RD_INIT, for the pattern source, are not supported.

Piecewise Linear

PWL T0 V0 [Tn Vn]*

PWL FILE "<name>" [TD=<timeDelay>] [R=<repeatTime>]

Table 2-64. Piecewise Linear Parameters

Parameter	Description	Units	Default
T_n	Time at Corner	s	none
V_n	Voltage at Corner	Volt	none
TD	Time Delay	s	0
R	Repeat Time	s	none

When the FILE option is given, Xyce will read the corner points from the file specified in the <name> field. This file should be a plain ASCII text file (or a .CSV file) with time/voltage pairs. There should be one pair per line, and the time and voltage values should be separated by whitespace or commas. As an example, the file specified (e.g., vpwl.csv) could have these five lines:

```
0.00, 0.00
2.00, 3.00
3.00, 2.00
4.00, 2.00
4.01, 5.00
```

The corresponding example instance lines would be:

```
VPWL1 1 0 PWL 0S 0V 2S 3V 3S 2V 4S 2V 4.01S 5V
VPWL2 2 0 PWL FILE "vpwl.txt"
VPWL3 3 0 PWL file "vpwl.csv"
VPWL4 4 0 PWL FILE vpwl.csv
```

The double quotes around the file name are optional, as shown above.

It is a best practice to specify all of the time-voltage pairs in the PWL specification. However, for compatibility with HSPICE and PSpice, if the user-specified list of time/voltage pairs omits the pair at time=0 as the first pair in the list then Xyce will insert a pair at time=0 with the voltage value at the first user-specified time value. As an example, this user-specified list:

2S 3V 3S 2V 4S 2V 4.01S 5V

would be implemented in Xyce as follows:

0S 3V 2S 3V 3S 2V 4S 2V 4.01S 5V

TD has units of seconds, and specifies the length of time to delay the start of PWL waveform. The default is to have no delay, and TD is an optional parameter.

The Repeat Time (R) is an optional parameter. If R is omitted then the waveform will not repeat. If R is included then the waveform will repeat until the end of the simulation. As examples, R=0 means repeat the PWL waveform from time=0 to the last time (T_N) specified in the waveform specification. (This would use the time points 0s, 2s, 3s, 4s and 4.01s for the example waveform given above.) In general, R=<repeatTime> means repeat the waveform from time equal to <repeatTime> seconds in the waveform specification to the last time (T_N) specified in the waveform specification. So, the <repeatTime> must be greater than or equal to 0 and less than the last time point (T_N). If the R parameter is used then it must have a value.

The specification PWL FILE "<name>" R is illegal in Xyce as a shorthand for R=0. Also, the Xyce syntax for PWL sources is not compatible with the PSpice REPEAT syntax for PWL sources. See section 6.1.12 for more details.

The repeat time (R) does enable the specification of discontinuous piecewise linear waveforms. For example, this waveform is a legal Xyce syntax.

VPWL1 1 0 PWL 0S 0V 2S 3V 3S 2V 4S 2V 4.01V 5V R=2

However, in general, discontinuous source waveforms may cause convergence problems.

Frequency Modulated

SFFM (V0 VA FC MDI FS)

Table 2-65. Frequency Modulated Parameters

Parameter	Description	Units	Default
V0	Offset	Volt	-
VA	Amplitude	Volt	-
FC	Carrier Frequency	hertz	1/TSTOP
MDI	Modulation Index	-	0
FS	Signal Frequency	hertz	1/TSTOP

TSTOP is the final time, as entered into the transient (.TRANS) command. The waveform is shaped according to the following equation:

$$V = V_0 + V_A \cdot \sin(2\pi \cdot FC \cdot \mathbf{TIME} + MDI \cdot \sin(2\pi \cdot FS \cdot \mathbf{TIME}))$$

where **TIME** is the current simulation time.

2.3.11. Port Device

Instance Form P<name> <(+) node> <(-) node> [[DC] <value>] port=port number
+ [Z0 = value] [AC [magnitude value [phase value]]]
+ [transient specification]

Examples

```
P1 1 0 port = 1
P2 12 0 port=1 z0=100
P1 1 0 port=2 sin 0 1 1e5
P2 2 0 port=2 z0=100 AC 1
```

Parameters and Options

port

The port number. Numbered sequentially beginning with 1

Z0 System impedance. Currently, it only supports a real-valued impedance.

transient specification

There are six predefined time-varying functions for sources:

PULSE <parameters> Pulse waveform

SIN <parameters> Sinusoidal waveform

EXP <parameters> Exponential waveform

PAT <parameters> Pattern waveform

PWL <parameters> Piecewise linear waveform

SFFM <parameters> Frequency-modulated waveform

Comments

The port device identifies the ports used in .LIN analysis. Each port requires a unique port number. For example, if the netlist has N port devices, it must contain the sequential set of port numbers, from 1 to N. Each port has an associated impedance Z0. The default is 50 ohms.

The port device behaves as a voltage source in series with an impedance for all other analyses, such as DC, AC and transient.

None, any, or all of the DC, AC, and transient values can be specified. The AC phase value is in degrees. The port device accepts the same transient specifications as the voltage (V) sources.

Positive current flows from the positive node through the port device to the negative node.

The power supplied or dissipated by the port device is calculated with $I \cdot \Delta V$ where the voltage drop is calculated as $(V_+ - V_-)$ and positive current flows from V_+ to V_- . Dissipated power has a positive sign, while supplied power has a negative sign.

2.3.12. Voltage Controlled Voltage Source



Instance Form E<name> <(+) node> <(-) node> <(+) controlling node>
+ <(-) controlling node> <gain>
E<name> <(+) node> <(-) node> VALUE = { <expression> }
+ [device parameters]
E<name> <(+) node> <(-) node> TABLE { <expression> } =
+ < <input value>,<output value> > *
E<name> <(+) node> <(-) node> POLY(<value>)
+ [<+ control node> <- control node>]*
+ [<polynomial coefficient value>]*

Examples EBUFFER 1 2 10 11 5.0
ESQROOT 5 0 VALUE = {5V*SQRT(V(3,2))}
ET2 2 0 TABLE {V(ANODE,CATHODE)} = (0,0) (30,1)
EP1 5 1 POLY(2) 3 0 4 0 0 .5 .5

Parameters and Options

(+) node

(-) node

Output nodes. Positive current flows from the (+) node through the source to the (-) node.

(+) controlling node

(-) controlling node

Node pairs that define a set of controlling voltages. A given node may appear multiple times and the output and controlling nodes may be the same.

device parameters

The second form supports two instance parameters `smoothbsrc` and `rcconst`. Parameters may be provided as space separated `<parameter>=<value>` specifications as needed. The default value for `smoothbsrc` is 0 and the default for `rcconst` is 1e-9.

Comments

In the first form, a specified voltage drop between controlling nodes is multiplied by the gain to determine the voltage drop across the output nodes.

The second through fourth forms allow nonlinear controlled sources using the `VALUE`, `TABLE`, or `POLY` keywords, respectively, and are used in analog behavioral modeling. They are provided primarily for netlist compatibility with other simulators. These three forms are automatically converted within Xyce to its principal ABM device, the B nonlinear dependent source device. See the B-source section (2.3.16) and the Xyce User's Guide for more guidance on analog behavioral modeling. For details concerning the use of the `POLY` format, see section 2.2.5.

For HSPICE compatibility, VOL is an allowed synonym for VALUE for the E-source.

The power supplied or dissipated by this source device is calculated with $I \cdot \Delta V$ where the voltage drop is calculated as $(V_+ - V_-)$ and positive current flows from V_+ to V_- . Dissipated power has a positive sign, while supplied power has a negative sign.

NOTE: The expression given on the left hand side of the equals sign in E source TABLE expressions may be enclosed in braces, but is not required to be. Further, if braces are present there must be exactly one pair of braces and it must enclose the entire expression. It is not legal to use additional pairs of braces as parentheses inside these expressions. So

```
ET2 2 0 TABLE {V(ANODE,CATHODE)+5} = (0,0) (30,1)
```

```
ET3 2 0 TABLE V(ANODE,CATHODE)+5 = (0,0) (30,1)
```

are legal, but

```
ET2 2 0 TABLE {V(ANODE,CATHODE)+{5}} = (0,0) (30,1)
```

is not. This last will result in a parsing error about missing braces.

E-sources were originally developed primarily to support DC and transient analysis. As such, their support for frequency domain analysis (AC and HB) has some limitations. The main limitation to be aware of is that time-dependent sources will not work with AC or HB analysis. These are sources in which the variable TIME is used in the VALUE= expression. However, this time-dependent usage is not common. The most common use case is one in which the E-source is purely dependent (depends only on other solution variables), and this use case will work with AC and HB.

2.3.13. Current Controlled Current Source



Symbol

Instance Form F<name> <(+) node> <(-) node>
 + <controlling V device name> <gain>
 F<name> <(+) node> <(-) node> POLY(<value>)
 + <controlling V device name>*
 + < <polynomial coefficient value> >*

Examples FSENSE 1 2 VSENSE 10.0
 FAMP 13 0 POLY(1) VIN 0 500
 FNONLIN 100 101 POLY(2) VCNTRL1 VCINTRL2 0.0 13.6 0.2 0.005

Parameters and Options

(+) node

(-) node

Output nodes. Positive current flows from the (+) node through the source to the (-) node.

controlling V device

The controlling voltage source which must be an independent voltage source (V device).

Comments

In the first form, a specified current through a controlling device is multiplied by the gain to determine this device's output current. The gain may be expressed either as a number, a parameter, or an arbitrary brace-delimited ABM expression.

The second form using the POLY keyword is used in analog behavioral modeling.

Both forms are automatically converted within Xyce to its principal ABM device, the B nonlinear dependent source device. See the B-source section (2.3.16) and the Xyce User's Guide for more guidance on analog behavioral modeling. For details concerning the use of the POLY format, see section 2.2.5.

The power supplied or dissipated by this source device is calculated with $I \cdot \Delta V$ where the voltage drop is calculated as $(V_+ - V_-)$ and positive current flows from V_+ to V_- . Dissipated power has a positive sign, while supplied power has a negative sign.

F-sources were originally developed primarily to support DC and transient analysis. As such, their support for frequency domain analysis (AC and HB) has some limitations. The main limitation to be aware of is that time-dependent sources will not work with AC or HB analysis. These are sources in which the variable TIME is used in the VALUE= expression. However, this time-dependent usage is not common. The most common use case is one in which the F-source is purely dependent (depends only on other solution variables), and this use case will work with AC and HB.

2.3.14. Voltage Controlled Current Source



Instance Form G<name> <(+) node> <(-) node> <(+) controlling node>
 + <(-) controlling node> <transconductance> [M=<value>]
G<name> <(+) <node> <(-) node> VALUE = { <expression> }
G<name> <(+) <node> <(-) node> TABLE { <expression> } =
+ < <input value>, <output value> > *
G<name> <(+) <node> <(-) node> POLY(<value>)
+ [<+ controlling node> <- controlling node>]*
+ [<polynomial coefficient>]*

Examples GBUFFER 1 2 10 11 5.0
 GPSK 11 6 VALUE = {5MA*SIN(6.28*10kHz*TIME+V(3))}
 GA2 2 0 TABLE {V(5)} = (0,0) (1,5) (10,5) (11,0)
 GMULT 1 2 10 11 3.0 M=5

Parameters and Options

(+) node

(-) node

Output nodes. Positive current flows from the (+) node through the source to the (-) node.

(+) controlling node

(-) controlling node

Node pairs that define a set of controlling voltages. A given node may appear multiple times and the output and controlling nodes may be the same.

Comments

In the first form, the voltage drop between the controlling nodes is multiplied by the transconductance to obtain the current-source output of the G device.

The second through fourth forms using the VALUE, TABLE, and POLY keywords, respectively, are used in analog behavioral modeling. They are provided primarily for netlist compatibility with other simulators. These two forms are automatically converted within Xyce to its principal ABM device, the B nonlinear dependent source device. See the B-source section (2.3.16) and the Xyce User's Guide for more guidance on analog behavioral modeling. For details concerning the use of the POLY format, see section 2.2.5.

For HSPICE compatibility, CUR is an allowed synonym for VALUE for the G-source. Also, this device supports the M multiplier parameter.

The power supplied or dissipated by this source device is calculated with $I \cdot \Delta V$ where the voltage drop is calculated as $(V_+ - V_-)$ and positive current flows from V_+ to V_- . Dissipated power has a positive sign, while supplied power has a negative sign.

G-sources were originally developed primarily to support DC and transient analysis. As such, their support for frequency domain analysis (AC and HB) has some limitations. The main limitation to be aware of is that time-dependent sources will not work with AC or HB analysis. These are sources in which the variable TIME is used in the VALUE= expression. However, this time-dependent usage is not common. The most common use case is one in which the G-source is purely dependent (depends only on other solution variables), and this use case will work with AC and HB.

2.3.15. Current Controlled Voltage Source

The syntax of this device is exactly the same as for a Current-Controlled Current Source. For a Current-Controlled Voltage Source just substitute an H for the F. The H device generates a voltage, whereas the F device generates a current.



Symbol

Instance Form H<name> <(+) node> <(-) node>
 + <controlling V device name> <transresistance>
 H<name> <(+) node> <(-) node> POLY(<value>)
 + <controlling V device name>*
 + < <polynomial coefficient value> >*

Examples HSENSE 1 2 VSENSE 10.0
 HAMP 13 0 POLY(1) VIN 0 500
 HNONLIN 100 101 POLY(2) VCNTRL1 VCINTRL2 0.0 13.6 0.2 0.005

Comments In the first form, the current through a specified controlling voltage source is multiplied by the transresistance to obtain the voltage-source output. The transresistance may be expressed either as a number, a parameter, or an arbitrary brace-delimited ABM expression.

 The second form using the POLY keyword is used in analog behavioral modeling. It is provided primarily for netlist compatibility with other simulators.

 H sources in any form are automatically converted within Xyce to its principal ABM device, the B nonlinear dependent source device. See the B-source section (2.3.16) and the Xyce User's Guide for more guidance on analog behavioral modeling. For details concerning the use of the POLY format, see section 2.2.5.

 The power supplied or dissipated by this source device is calculated with $I \cdot \Delta V$ where the voltage drop is calculated as $(V_+ - V_-)$ and positive current flows from V_+ to V_- . Dissipated power has a positive sign, while supplied power has a negative sign.

 H-sources were originally developed primarily to support DC and transient analysis. As such, their support for frequency domain analysis (AC and HB) has some limitations. The main limitation to be aware of is that time-dependent sources will not work with AC or HB analysis. These are sources in which the variable TIME is used in the VALUE= expression. However, this time-dependent usage is not common. The most common use case is one in which the H-source is purely dependent (depends only on other solution variables), and this use case will work with AC and HB.

2.3.16. Nonlinear Dependent Source

Instance Form B<name> <(+) node> <(-) node> V=ABM expression [device parameters]
 B<name> <(+) node> <(-) node> I=ABM expression [device parameters]

Examples

```
B1 2 0 V={sqrt(V(1))}
B2 4 0 V={V(1)*TIME}
B3 4 2 I={I(V1) + V(4,2)/100} M=100
B4 5 0 V={Table {V(5)}=(0,0) (1.0,2.0) (2.0,3.0) (3.0,10.0)}
B5 6 0 V=tablefile("file.dat")
B6 7 0 I=tablefile("file.dat") M=2
B5 6 0 V=table("file.dat")
B6 7 0 I=table("file.dat")
B5 6 0 V={table("file.dat")}
B5 6 0 V={spline("file.dat")}
B5 6 0 V={BLI("file.dat")}
B5 6 0 V={fasttable("file.dat")}
```

Comments The nonlinear dependent source device, also known as the B-source device, is used in analog behavioral modeling (ABM). The (+) and (-) nodes are the output nodes. Positive current flows from the (+) node through the source to the (-) node.

The power supplied or dissipated by the nonlinear dependent source is calculated with $I \cdot \Delta V$ where the voltage drop is calculated as $(V_+ - V_-)$ and positive current flows from V_+ to V_- . Dissipated power has a positive sign, while supplied power has a negative sign.

The syntax involving the `tablefile` keyword internally attempts to load the data in "file.dat" into a TABLE expression. The data file must be in plain-text and contain just two pairs of data per line. For an example see the "Analog Behavioral Modeling" chapter of the Xyce User's Guide. Either `table` or `tablefile` can be used to read a table in from a file. They are synonyms.

Other related table-based features include `fasttable`, which is the same as `table` but without many breakpoints, and `bli` for Barycentric Lagrange Interpolation [10]. Various splines are also supported, including `spline`, `cubic`, `akima` [8] and `wodicka` [9]. `spline` and `akima` are synonymous. All of these methods use the same syntax as `table`, and all of them support reading tables in from files.

It is important to note that the B-source allows the user to specify expressions that could have infinite-slope transitions, such as the following. (Note: the braces surrounding all expressions are required in this definition.)

```
Bcrt1 OUTA 0 V={ IF( (V(IN) > 3.5), 5, 0 ) }
```

This can lead to "timestep too small" errors when Xyce reaches the transition point. Infinite-slope transitions in expressions dependent only on the `time` variable are a special case, because Xyce can detect that they are going to happen in the future and

set a “breakpoint” to capture them. Infinite-slope transitions depending on other solution variables cannot be predicted in advance, and cause the time integrator to scale back the timestep repeatedly in an attempt to capture the feature until the timestep is too small to continue.

One solution to the problem is to modify the expression to allow a continuous transition. However, this can become complicated with multiple inputs. The other solution is to specify device options or instance parameters to allow smooth transitions. The parameter `smoothbsrc` enables the smooth transitions. This is done by adding a RC network to the output of B sources. For example,

```
Bcrtl OUTA 0 V={ IF( (V(IN) > 3.5), 5, 0 ) } smoothbsrc=1
.options device smoothbsrc=1
```

The smoothness of the transition can be controlled by specifying the rc constant of the RC network. For example,

```
Bcrtl OUTA 0 V={ IF( (V(IN) > 3.5), 5, 0 ) } smoothbsrc=1
+ rcconst = 1e-10
```

Note that this smoothed B-source only applies to voltage sources. The voltage behavioral source supports two instance parameters `smoothbsrc` and `rcconst`. Parameters may be provided as space separated `<parameter>=<value>` specifications as needed. The default value for `smoothbsrc` is 0 and the default for `rcconst` is 1e-9.

See the “Analog Behavioral Modeling” chapter of the Xyce User’s Guide [1] for guidance on using the B-source device and ABM expressions, and the Expressions Section (2.2) for complete documentation of expressions and expression operators. One important note is that time-dependent expressions are supported for the current and voltage parameters of a B source, but frequency-dependent expressions are not.

B-sources were originally developed primarily to support DC and transient analysis. As such, their support for frequency domain analysis (AC and HB) has some limitations. The main limitation to be aware of is that time-dependent sources will not work with AC or HB analysis. These are sources in which the variable `TIME` is used in the `VALUE=` expression. The use case of a purely dependent B-source (depends only on other solution variables) will work with AC and HB.

The B-source supports the multiplier parameter (`M`) but only for current sources.

Device Parameters

Table 2-66. Expression Based Voltage or Current Source Device Instance Parameters

Parameter	Description	Units	Default
I	Current for current source	A	0
M	Multiplicity Factor for current sources	–	1
RCCONST	rc time constant	s	1e-09
SMOOTHBSRC	smooth bsrc	logical (T/F)	false
TEMP	Device temperature	°C	Ambient Temperature
V	Voltage for voltage source	V	0

2.3.17. Bipolar Junction Transistor (BJT)

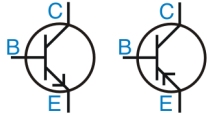

Symbol

Instance Form

Q<name> <collector node> <base node> <emitter node>
+ [substrate node] <model name> [area value]

Q<name> <collector node> <base node> <emitter node>
+ [thermal node] <VBIC 1.3 3-terminal model name>

Q<name> <collector node> <base node> <emitter node>
+ <substrate> [thermal node] <VBIC 1.3 4-terminal model name>

Q<name> <collector node> <base node> <emitter node>
+ <substrate> <thermal node> <HICUM model name>

Model Form

.MODEL <model name> NPN [model parameters]
.MODEL <model name> PNP [model parameters]

Examples

```
Q2 10 2 9 PNP1
Q12 14 2 0 1 NPN2 2.0
Q6 VC 4 11 [SUB] LAXPNP
Q7 Coll Base Emit DT VBIC13MODEL2
Q8 Coll Base Emit VBIC13MODEL3 SW_ET=0
Q9 Coll Base Emit Subst DT VBIC13MODEL4
Q10 Coll Base Emit Subst DT HICUMMODEL1
```

Parameters and Options

substrate node

Optional and defaults to ground. Since Xyce permits alphanumeric node names and because there is no easy way to make a distinction between these and the model names, the name (not a number) used for the substrate node must be enclosed in square brackets []. Otherwise, nodes would be interpreted as model names. See the fourth example above.

area value

The relative device area with a default value of 1.

Comments

The BJT is modeled as an intrinsic transistor using ohmic resistances in series with the collector ($RC/area$), with the base (value varies with current, see BJT equations) and with the emitter ($RE/area$). For model parameters with optional names, such as VAF and VA (the optional name is in parentheses), either may be used. For model types NPN and PNP, the isolation junction capacitance is connected between the

intrinsic-collector and substrate nodes. This is the same as in SPICE and works well for vertical IC transistor structures.

Only the VBIC 1.3 model is available in Xyce 6.11 and later. The VBIC 1.3 model is provided in both 3-terminal (Q level 11) and 4-terminal (Q level 12) variants, both supporting electrothermal and excess-phase effects. These variants of the Q line are shown in the fourth through sixth examples above. VBIC 1.3 instance lines have three or four required nodes, depending on model level, and an *optional* “dt” node. The first three are the normal collector, base, and emitter. In the level 12 (4-terminal) the fourth node is the substrate, just as for the level 1 BJT. If the optional “dt” node is specified for either variant, it can be used to print the local temperature rise due to self-heating, and could possibly be used to model coupled heating effects of several VBIC devices. It is, however, unnecessary to specify a “dt” node just to print the local temperature rise, because when this node is omitted from the instance line it simply becomes an internal node, and may still be printed using the syntax `N(instance:dt)`. For the “Q8” example above, one could print `N(Q8:dt)`.

As of release 6.10 of Xyce, the VBIC 1.3 3-terminal device (Q level 11) has been the subject of extensive optimization, and runs much faster than in previous releases.

The HICUM models require both a substrate and thermal node.

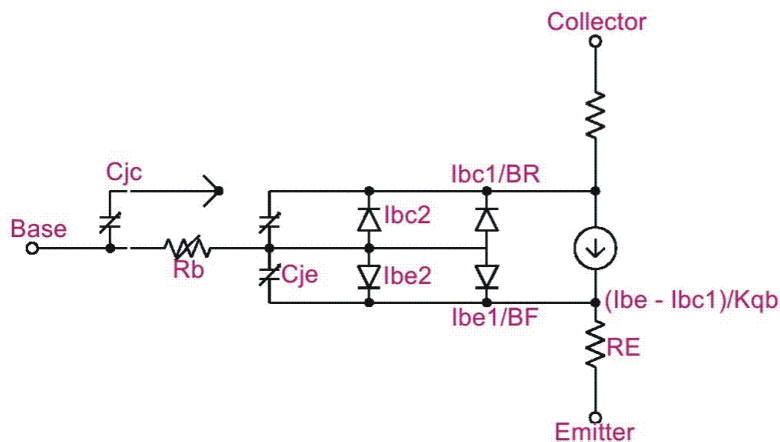

Figure 2-3. BJT model schematic. Adapted from reference [2].

BJT Level selection Xyce supports the level 1 BJT model, which is based on the documented standard SPICE 3F5 BJT model, but was coded independently at Sandia. It is mostly based on the classic Gummel-Poon BJT model [12].

Two variants of the VBIC model are provided as BJT levels 11 and 12. Levels 11 and 12 are the 3-terminal and 4-terminal variants of the VBIC 1.3.

An experimental release of the FBH HBT_X model version 2.1[13] is provided as BJT level 23.

Both the HICUM/L0 (level 230) and HICUM/L2 (level 234) models are also provided (https://www.iee.et.tu-dresden.de/iee/eb/hic_new/hic_start.html).

The MEXTRAM[14] BJT model version 504.12.1 model is provided. Two variants of this model are available: the level 504 model without self-heating and without external substrate node, and the level 505 model with self heating but without external substrate node. The level 505 instance line requires a fourth node for the 'dt' node, similar to the usage in all of the VBIC models (levels 11-12), but is otherwise identical to the level 504 model.

BJT Power Calculations Power dissipated in the transistor is calculated with $|I_B * V_{BE}| + |I_C * V_{CE}|$, where I_B is the base current, I_C is the collector current, V_{BE} is the voltage drop between the base and the emitter and V_{CE} is the voltage drop between the collector and the emitter. This formula may differ from other simulators.

2.3.17.1. The Level 1 Model

BJT Equations The Level 1 BJT implementation within Xyce is based on [15]. The equations in this section describe an NPN transistor. For the PNP device, reverse the signs of all voltages and currents. The equations use the following variables:

- V_{be} = intrinsic base-intrinsic emitter voltage
- V_{bc} = intrinsic base-intrinsic collector voltage
- V_{bs} = intrinsic base-substrate voltage
- V_{bw} = intrinsic base-extrinsic collector voltage (quasi-saturation only)
- V_{bx} = extrinsic base-intrinsic collector voltage
- V_{ce} = intrinsic collector-intrinsic emitter voltage
- V_{js} = (NPN) intrinsic collector-substrate voltage
= (PNP) intrinsic substrate-collector voltage
- V_t = kT/q (thermal voltage)
- V_{th} = threshold voltage
- k = Boltzmann's constant
- q = electron charge
- T = analysis temperature (K)
- T_0 = nominal temperature (set using **TNOM** option)

Other variables are listed above in BJT Model Parameters.

DC Current The BJT model is based on the Gummel and Poon model [16] where the different terminal currents are written

$$\begin{aligned}
 I_e &= -I_{cc} - I_{be} + I_{re} + (C_{dife} + C_{de}) \frac{dV_{be}}{dt} \\
 I_c &= -I_{cc} + I_{bc} - I_{rc} - (C_{difc} + C_{dc}) \frac{dV_{bc}}{dt} \\
 I_b &= I_e - I_c
 \end{aligned}$$

Here, C_{dife} and C_{difc} are the capacitances related to the hole charges per unit area in the base, Q_{dife} and Q_{difc} , affiliated with the electrons introduced across the emitter-base and collector-base junctions,

respectively. Also, C_{be} and C_{bc} are the capacitances related to donations to the hole charge of the base, Q_{be} and Q_{bc} , affiliated with the differences in the depletion regions of the emitter-base and collector-base junctions, respectively. The intermediate currents used are defined as

$$\begin{aligned} -I_{be} &= \frac{\mathbf{IS}}{\mathbf{BF}} \left[\exp\left(\frac{V_{be}}{\mathbf{NF}V_{th}}\right) - 1 \right] \\ -I_{cc} &= \frac{Q_{bo}}{Q_b} \mathbf{IS} \left[\exp\left(\frac{V_{be}}{\mathbf{NF}V_{th}}\right) - \exp\left(\frac{V_{bc}}{\mathbf{NF}V_{th}}\right) \right] \\ -I_{bc} &= \frac{\mathbf{IS}}{\mathbf{BR}} \left[\exp\left(\frac{V_{bc}}{\mathbf{NR}V_{th}}\right) - 1 \right] \\ I_{re} &= \mathbf{ISE} \left[\exp\left(\frac{V_{be}}{\mathbf{NE}V_{th}}\right) - 1 \right] \\ I_{rc} &= \mathbf{ISC} \left[\exp\left(\frac{V_{bc}}{\mathbf{NC}V_{th}}\right) - 1 \right] \end{aligned}$$

where the last two terms are the generation/recombination currents related to the emitter and collector junctions, respectively. The charge Q_b is the majority carrier charge in the base at large injection levels and is a key difference in the Gummel-Poon model over the earlier Ebers-Moll model. The ratio Q_b/Q_{bo} (where Q_{bo} represents the zero-bias base charge, i.e. the value of Q_b when $V_{be} = V_{bc} = 0$) as computed by Xyce is given by

$$\frac{Q_b}{Q_{bo}} = \frac{q_1}{2} \left(1 + \sqrt{1 + 4q_2} \right)$$

where

$$\begin{aligned} q_1 &= \left(1 - \frac{V_{be}}{\mathbf{VAR}} - \frac{V_{bc}}{\mathbf{VAF}} \right)^{-1} \\ q_2 &= \frac{\mathbf{IS}}{\mathbf{IKF}} \left[\exp\left(\frac{V_{be}}{\mathbf{NF}V_{th}}\right) - 1 \right] + \frac{\mathbf{IS}}{\mathbf{IKR}} \left[\exp\left(\frac{V_{bc}}{\mathbf{NR}V_{th}}\right) - 1 \right] \end{aligned}$$

Capacitance Terms The capacitances listed in the above DC $I - V$ equations each consist of a depletion layer capacitance C_d and a diffusion capacitance C_{dif} . The first is given by

$$C_d = \begin{cases} \mathbf{CJ} \left(1 - \frac{V_{di}}{\mathbf{VJ}} \right)^{-M} & V_{di} \leq \mathbf{FC} \cdot \mathbf{VJ} \\ \mathbf{CJ} (1 - \mathbf{FC})^{-(1+M)} \left[1 - \mathbf{FC}(1 + M) + M \frac{V_{di}}{\mathbf{VJ}} \right] & V_{di} > \mathbf{FC} \cdot \mathbf{VJ} \end{cases}$$

where $\mathbf{CJ} = \mathbf{CJE}$ for C_{de} , and where $\mathbf{CJ} = \mathbf{CJC}$ for C_{dc} . The diffusion capacitance (sometimes referred to as the transit time capacitance) is

$$C_{dif} = \mathbf{TT}G_d = \mathbf{TT} \frac{dI}{dV_{di}}$$

where I is the diode DC current given, G_d is the corresponding junction conductance, and where $\mathbf{TT} = \mathbf{TF}$ for C_{dife} and $\mathbf{TT} = \mathbf{TR}$ for C_{difc} .

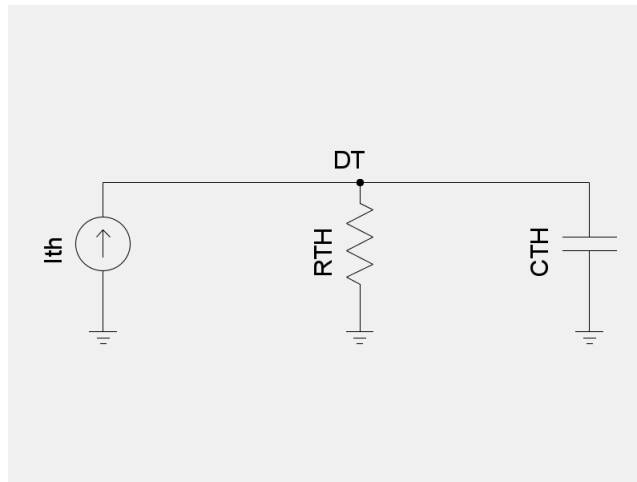

Figure 2-4. VBIC thermal network schematic.

Temperature Effects SPICE temperature effects are default, but all levels of the BJT have a more advanced temperature compensation available. By specifying `TEMPMODEL=QUADRATIC` in the netlist, parameters can be interpolated quadratically between measured values extracted from data. In the BJT, `IS` and `ISE` are interpolated logarithmically because they can change over an order of magnitude or more for temperature ranges of interest. See the Section ?? for more details on how to include quadratic temperature effects.

For further information on BJT models, see [16]. For a thorough description of the U.C. Berkeley SPICE models see Reference [17].

2.3.17.2. VBIC Temperature Considerations

The VBIC (Q levels 11 and 12) model both support a self-heating model. The model works by computing the power dissipated by all branches of the device, applying this power as a flow through a small thermal network consisting of a power flow (“current”) source through a thermal resistance and thermal capacitance, as shown in Figure 2-4. The circuit node `DT` will therefore be the “thermal potential” (temperature) across the parallel thermal resistance and capacitance. This temperature is the temperature rise due to self heating of the device, which is added to the ambient temperature and `TRISE` parameter to obtain the device operating temperature.

In VBIC 1.3, the `dt` node is optional on the netlist line. If not given, the `dt` node is used internally for thermal effects calculations, but not accessible from the rest of the netlist. The VBIC 1.3 provides an instance parameter `SW_ET` that may be set to zero to turn off electrothermal self-heating effects. When set to zero, no thermal power is sourced into the `dt` node. This parameter defaults to 1, meaning that thermal power is computed and flows into `dt` even when `dt` is unspecified on the netlist and remains an internal node.

In VBIC 1.3, setting `RTH` to zero does *NOT* disable the self-heating model, and does not short the `dt` node to ground, even though one might expect that to be the behavior. Rather, it simply removes the `RTH` resistor from the equivalent circuit of figure 2-4 and leaves the `dt` node floating. This is an important point to recognize when using the VBIC.

If a node name is given as the fourth node of a VBIC Xyce will emit warnings about the node not having a DC path to ground and being connected to only one device. These warnings may safely be ignored, and are a harmless artifact of Xyce's connectivity checker. It is possible to silence this warning by adding a very large resistance between the dt node and ground — 1GOhm or 1TOhm are effectively the same as leaving the node floating, and will satisfy the connectivity checker's tests. This used to be the recommended means of silencing the connectivity checker for the VBIC 1.2 where dt was a required node, but it is safe *if and only if a nonzero RTH value is specified for the device*. If, however, RTH is zero, then dt would otherwise be floating and your external resistance now becomes the primary path for thermal power flow; rather than turning off self-heating effects, it will be as if you had set RTH to a very large value. We therefore recommend that you not tie the dt node to ground via a resistor, and if you are not using it to connect VBIC devices together via a thermal network, simply leave off the dt node to silence the connectivity checker warning. Turn off self-heating effects ONLY by setting the SW_ET instance parameter to zero.

Users of earlier versions of Xyce may have been using the VBIC 1.2 model that was removed in release 6.11. All netlists containing the old level=10 VBIC 1.2 model must be modified to run in Xyce 6.11 and later. The following points should be observed when converting an old VBIC 1.2 netlist and model card to VBIC 1.3.

- Generally speaking, most VBIC 1.2 model cards can be converted to VBIC 1.3 model cards by the simple substitution of level=11 for level=10, with the following provisos.
- VBIC 1.2 in Xyce 6.10 and earlier did not support excess phase effects, and so the TD parameter governing excess phase was ignored.

The Xyce team has observed that some users' VBIC 1.2 parameter extractions have a non-zero value for the TD parameter. The impact of this is twofold:

- Circuits that use such model cards with only the level number changed will likely not produce identical results when compared to simulation results of older versions of Xyce using VBIC 1.2 due to the excess phase effects. If strict comparison between VBIC 1.3 runs with Xyce 6.11 or later against older runs with VBIC 1.2 is desired, change the TD parameter to zero. This will disable the excess phase effects and make VBIC 1.3 equivalent to the VBIC 1.2 that was previously provided.
 - The Xyce team has seen some instances where the previously ignored TD parameter value is such that Xyce will fail to converge when the equivalent VBIC 1.3 model is substituted. The VBIC 1.2 behavior can be recovered by setting the model parameter TD to zero, which will disable the excess phase effect in VBIC 1.3. We can only suggest that the model card be re-extracted using VBIC 1.3 to determine the correct value for TD.
- VBIC 1.2 had a model parameter called DTEMP, which Xyce also recognized on the instance line. In VBIC 1.3 this parameter has been replaced by another called TRISE, which is only an instance parameter, and is unrecognized in model cards. VBIC 1.3 also recognizes DTEMP on the instance line as an alias for TRISE. If you had been specifying DTEMP in your VBIC 1.2 model cards, you will need to move it to the instance line instead in order for the parameter to be properly recognized by both VBIC 1.2 and VBIC 1.3.
 - Turning off self-heating effects in VBIC 1.2 was done by grounding the mandatory dt node. This is not the recommended way of disabling self-heating in VBIC 1.3. To disable self-heating, set the SW_ET parameter to zero on the instance line (as is done in the "Q8" example above).

- If not using the dt node as a way of thermally coupling devices to each other, leave it off of VBIC 1.3 instance lines, allowing it to be an internal variable irrespective of whether self-heating is enabled or not. This will silence any connectivity warnings from Xyce. Since the dt node may be printed using the N() syntax even when internal, it is unnecessary to put a dt node on the instance line just to print the local temperature rise due to self-heating. The only reasons to include it on the instance line would be for backward compatibility to VBIC 1.2 netlists, or to implement a thermal coupling network between devices.
- Finally, VBIC 1.3 introduced a number of constraints on model parameters that the previous version did not. Xyce will emit warnings if any parameter on a VBIC 1.3 model card is out of the range specified by the VBIC 1.3 authors. These warnings should not be ignored lightly, as they indicate that the model is being used in a manner not intended by its authors. They are generally a sign that the model may not be well-behaved, and may indicate an improperly extracted model card.

2.3.17.3. Level 1 BJT Tables

Table 2-67. Bipolar Junction Transistor Device Instance Parameters

Parameter	Description	Units	Default
AREA	Relative device area	–	1
DTEMP	Device delta temperature	°C	0
IC1	Vector of initial values: Vbe,Vce. Vbe=IC1	V	0
IC2	Vector of initial values: Vbe,Vce. Vce=IC2	V	0
M	multiplicity factor	–	1
OFF	Initial condition of no voltage drops accross device	logical (T/F)	false
TEMP	Device temperature	°C	Ambient Temperature

Table 2-68. Bipolar Junction Transistor Device Model Parameters

Parameter	Description	Units	Default
AF	Flicker noise exponent	—	1
BF	Ideal maximum foward beta	–	100
BFM	Ideal maximum foward beta	–	100
BR	Ideal maximum reverse beta	–	1
BRM	Ideal maximum reverse beta	–	1
BV	Reverse early voltage	V	0
C2	Coefficient for base-emitter leak current.	—	0
C4	Coefficient for base-collector leak current.	—	0
CCS	Substrate zero-bias p-n capacitance	F	0
CDIS	Fraction of CJC connected internally to RB	–	1

Table 2-68. Bipolar Junction Transistor Device Model Parameters

Parameter	Description	Units	Default
CJC	Base-collector zero-bias p-n capacitance	F	0
CJE	Base-emitter zero-bias p-n capacitance	F	0
CJS	Substrate zero-bias p-n capacitance	F	0
CSUB	Substrate zero-bias p-n capacitance	F	0
EG	Bandgap voltage (barrier highth)	eV	1.11
ESUB	Substrate p-n grading factor	–	0
FC	Foward-bias depletion capacitor coefficient	–	0.5
IK	Corner for foward-beta high-current roll-off	A	0
IKF	Corner for foward-beta high-current roll-off	A	0
IKR	Corner for reverse-beta high-current roll-off	A	0
IOB	Current at which RB falls off by half	A	0
IRB	Current at which RB falls off by half	A	0
IS	Transport saturation current	A	1e-16
ISC	Base-collector leakage saturation current	A	0
ISE	Base-emitter leakage saturation current	A	0
ITF	Transit time dependancy on IC	—	0
JBF	Corner for foward-beta high-current roll-off	A	0
JBR	Corner for reverse-beta high-current roll-off	A	0
JLC	Base-collector leakage saturation current	A	0
JLE	Base-emitter leakage saturation current	A	0
JRB	Current at which RB falls off by half	A	0
JTF	Transit time dependancy on IC	—	0
KF	Flicker noise coefficient	–	0
MC	Base-collector p-n grading factor	–	0.33
ME	Base-emitter p-n grading factor	–	0.33
MJC	Base-collector p-n grading factor	–	0.33
MJE	Base-emitter p-n grading factor	–	0.33
MJS	Substrate p-n grading factor	–	0
MS	Substrate p-n grading factor	–	0
NC	Base-collector leakage emission coefficient	–	2
NE	Base-emitter leakage emission coefficient	–	1.5
NF	Foward current emission coefficient	–	1
NK	High current rolloff coefficient	–	0.5
NKF	High current rolloff coefficient	–	0.5
NLE	Base-emitter leakage emission coefficient	–	1.5
NR	Reverse current emission coefficient	–	1

Table 2-68. Bipolar Junction Transistor Device Model Parameters

Parameter	Description	Units	Default
PC	Base-collector built-in potential	V	0.75
PE	Base-emitter built-in potential	V	0.75
PS	Substrate built-in potential	V	0.75
PSUB	Substrate built-in potential	V	0.75
PT	Temperature exponent for IS. (synonymous with XTI)	—	3
PTF	Excess Phase at $1/(2\pi*TF)$ Hz	degree	0
RB	Zero-bias (maximum) base resistance	Ω	0
RBM	Maximum base resistance	Ω	0
RC	Collector ohmic resistance	Ω	0
RE	Emitter ohmic resistance	Ω	0
TB	Foward and reverse beta temperature coefficient	—	0
TCB	Foward and reverse beta temperature coefficient	—	0
TEMPMODEL	Specifies the type of parameter interpolation over temperature	—	'NONE'
TF	Ideal foward transit time	s	0
TNOM	Parameter measurement temperature	$^{\circ}\text{C}$	Ambient Temperature
TR	Ideal reverse transit time	s	0
VA	Foward early voltage	V	0
VAF	Foward early voltage	V	0
VAR	Reverse early voltage	V	0
VB	Reverse early voltage	V	0
VBF	Foward early voltage	V	0
VJC	Base-collector built-in potential	V	0.75
VJE	Base-emitter built-in potential	V	0.75
VJS	Substrate built-in potential	V	0.75
VRB	Reverse early voltage	V	0
VTF	Transit time dependancy on Vbc	V	0
XCJC	Fraction of CJC connected internally to RB	—	1
XTB	Foward and reverse beta temperature coefficient	—	0
XTF	Transit time bias dependence coefficient	—	0
XTI	Temperature exponent for IS. (synonymous with PT)	—	3

2.3.17.4. Level 11 and 12 BJT Tables (VBIC 1.3)

The VBIC 1.3 (level 11 transistor for 3-terminal, level 12 for 4-terminal) supports a number of instance parameters that are not available in the VBIC 1.2. The level 11 and level 12 differ only by the number of

required nodes. The level 11 is the 3-terminal device, having only collector, base, and emitter as required nodes. The level 12 is the 4-terminal device, requiring collector, base, emitter and substrate nodes. Both models support an optional 'dt' node as their last node on the instance line.

Model cards extracted for the VBIC 1.2 will mostly work with the VBIC 1.3, with one notable exception: in VBIC 1.2 the DTEMP parameter was a model parameter, and Xyce allowed it also to be specified on the instance line, overriding whatever was specified in the model. This parameter was replaced in VBIC 1.3 with the TRISE parameter, which is *only* an instance parameter. DTEMP and DTA are both supported as aliases for the TRISE instance parameter.

Table 2-69. VBIC 1.3 3T Device Instance Parameters

Parameter	Description	Units	Default
DTA	Alias for trise	°C	0
DTEMP	Alias for trise	°C	0
M	multiplicity factor	—	1
OFF	Set to 1 to initialize device to OFF instead of normally	—	0
SW_ET	switch for self-heating: 0=no and 1=yes	—	1
SW_NOISE	switch for including noise: 0=no and 1=yes	—	1
TRISE	local temperature delta to ambient (before self-heating)	°C	0

Table 2-70. VBIC 1.3 3T Device Model Parameters

Parameter	Description	Units	Default
ABK	SiGe base current kink exponent	—	1
AFN	b-e flicker noise current exponent	—	1
AJC	b-c capacitance smoothing factor	—	-0.5
AJE	b-e capacitance smoothing factor	—	-0.5
AJS	c-s capacitance smoothing factor	—	-0.5
ART	smoothing parameter for reach-through	—	0.1
AVC1	b-c weak avalanche parameter 1	V ⁻¹	0
AVC2	b-c weak avalanche parameter 2	—	0
AVCX1	bx-cx weak avalanche parameter 1	V ⁻¹	0
AVCX2	bx-cx weak avalanche parameter 2	—	0
BBK	SiGe base current kink current factor	A	0
BFN	b-e flicker noise 1/f exponent	—	1
CBCO	extrinsic b-c overlap capacitance	F	0
CBE0	extrinsic b-e overlap capacitance	F	0
CCSO	extrinsic c-s overlap capacitance	F	0
CJC	zero-bias b-c depletion capacitance	F	0

Table 2-70. VBIC 1.3 3T Device Model Parameters

Parameter	Description	Units	Default
CJCP	zero-bias extrinsic c-s depletion capacitance	F	0
CJE	zero-bias b-e depletion capacitance	F	0
CJEP	zero-bias extrinsic b-c depletion capacitance	F	0
CTH	thermal capacitance	—	0
DEAR	delta activation energy for isrr	V	0
EA	activation energy for is	V	1.12
EAIC	activation energy for ibci and ibeip	V	1.12
EAIE	activation energy for ibei	V	1.12
EAIS	activation energy for ibcip	V	1.12
EANC	activation energy for ibcn and ibenp	V	1.12
EANE	activation energy for iben	V	1.12
EANS	activation energy for ibcnp	V	1.12
EAP	activation energy for isp	V	1.12
FC	forward bias depletion capacitance limit	—	0.9
GAMM	epi doping parameter	—	0
GMIN	minimum conductance	Ω^{-1}	1e-12
HRCF	high current collector resistance factor	—	0
IBBE	b-e breakdown current	A	1e-06
IBCI	ideal b-c saturation current	A	1e-16
IBCIP	ideal parasitic b-c saturation current	A	0
IBCN	non-ideal b-c saturation current	A	0
IBCNP	non-ideal parasitic b-c saturation current	A	0
IBEI	ideal b-e saturation current	A	1e-18
IBEIP	ideal parasitic b-e saturation current	A	0
IBEN	non-ideal b-e saturation current	A	0
IBENP	non-ideal parasitic b-e saturation current	A	0
IBK0	SiGe base current kink current reference	A	0
IKF	forward knee current (zero=infinite)	A	0
IKP	parasitic knee current (zero=infinite)	A	0
IKR	reverse knee current (zero=infinite)	A	0
IS	transport saturation current	A	1e-16
ISP	parasitic transport saturation current	A	0
ISRR	ratio of is(reverse) to is(forward)	—	1
ITF	tf coefficient of Ic dependence	A	0
KFN	b-e flicker noise constant	—	0
MAXEXP	argument at which to linearize general exponentials	—	1e+22

Table 2-70. VBIC 1.3 3T Device Model Parameters

Parameter	Description	Units	Default
MC	b-c grading coefficient	—	0.33
MCX	bx-cx grading coefficient for avalanche	—	0.33
ME	b-e grading coefficient	—	0.33
MS	c-s grading coefficient	—	0.33
NBBE	b-e breakdown emission coefficient	—	1
NCI	ideal b-c emission coefficient	—	1
NCIP	ideal parasitic b-c emission coefficient	—	1
NCN	non-ideal b-c emission coefficient	—	2
NCNP	non-ideal parasitic b-c emission coefficient	—	2
NEI	ideal b-e emission coefficient	—	1
NEN	non-ideal b-e emission coefficient	—	2
NF	fwd emission coefficient (ideality factor)	—	1
NFP	parasitic emission coeff (ideality factor)	—	1
NKF	high current beta roll-off parameter	—	0.5
NPN	nnp transistor type	—	0
NR	rev emission coefficient (ideality factor)	—	1
OFF	Set to 1 to initialize device to OFF instead of normally	—	0
PC	b-c built-in potential	V	0.75
PE	b-e built-in potential	V	0.75
PNJMAXI	current at which to linearize diode currents	A	1
PNP	pnnp transistor type	—	0
PS	c-s built-in potential	V	0.75
QBM	base charge model selection switch: 0=GP and 1=SGP	—	0
QCO	epi charge parameter	C	0
QNIBEIR	ideal b-e quasi-neutral base recombination parameter	—	0
QTF	variation of tf with base-width modulation	—	0
RBI	intrinsic base resistance	Ω	0
RBP	parasitic transistor base resistance	Ω	0
RBX	extrinsic base resistance	Ω	0
RCI	intrinsic collector resistance	Ω	0
RCX	extrinsic collector resistance	Ω	0
RE	extrinsic emitter resistance	Ω	0
RS	extrinsic substrate resistance	Ω	0
RTH	thermal resistance	—	0
SCALE	scale factor for instance geometries	—	1
SHRINK	shrink percentage for instance geometries	—	0

Table 2-70. VBIC 1.3 3T Device Model Parameters

Parameter	Description	Units	Default
TAVC	temperature exponent of avc2	°C ⁻¹	0
TAVCX	temperature exponent of avcx2	°C ⁻¹	0
TCRTH	temperature exponent of rth	°C ⁻¹	0
TCVEF	temperature exponent of vef	°C ⁻¹	0
TCVER	temperature exponent of ver	°C ⁻¹	0
TD	forward excess-phase delay time	s	0
TF	forward transit time	s	0
TMAX	maximum ambient temperature	°C	500
TMAXCLIP	clip maximum temperature	°C	500
TMIN	minimum ambient temperature	°C	-100
TMINCLIP	clip minimum temperature	°C	-100
TNBBE	temperature coefficient of nbbe	°C ⁻¹	0
TNF	temperature exponent of nf and nr	°C ⁻¹	0
TNOM	nominal (reference) temperature	°C	27
TR	reverse transit time	s	0
TVBBE1	linear temperature coefficient of vbbe	°C ⁻¹	0
TVBBE2	quadratic temperature coefficient of vbbe	—	0
TYPE	transistor type: -1=npn and +1=pnp (overridden by npn or pnp)	—	-1
VBBE	b-e breakdown voltage	V	0
VEF	forward Early voltage (zero=infinite)	V	0
VER	reverse Early voltage (zero=infinite)	V	0
VO	epi drift saturation voltage	V	0
VPTE	SiGe base current kink voltage	V	0
VRT	reach-through voltage for Cbc limiting	V	0
VTF	tf coefficient of Vbci dependence	V	0
WBE	partitioning of Ibe/Ibex and Qbe/Qbex	—	1
WSP	partitioning of Iccp between Vbep and Vbci	—	1
XII	temperature exponent of ibei, ibci, ibeip, ibcip	—	3
XIKF	temperature exponent of ikf	—	0
XIN	temperature exponent of iben, ibcn, ibenp, ibcnp	—	3
XIS	temperature exponent of is	—	3
XISR	temperature exponent for isrr	—	0
XRIB	temperature exponent of rbx and rbi	—	0
XRBI	temperature exponent of rbi (overrides xrb)	—	0
XRBP	temperature exponent of rbp (overrides xrc)	—	0

Table 2-70. VBIC 1.3 3T Device Model Parameters

Parameter	Description	Units	Default
XR BX	temperature exponent of r _{bx} (overrides x _{rb})	—	0
XRC	temperature exponent of r _{ci} and r _{cx} and r _{bp}	—	0
XRCI	temperature exponent of r _{ci} (overrides x _{rc})	—	0
XRCX	temperature exponent of r _{cx} (overrides x _{rc})	—	0
XRE	temperature exponent of r _e	—	0
XRS	temperature exponent of r _s	—	0
XTF	tf bias dependence coefficient	—	0
XVO	temperature exponent of v _o	—	0

Table 2-71. VBIC 1.3 4T Device Instance Parameters

Parameter	Description	Units	Default
DTA	Alias for trise	°C	0
DTEMP	Alias for trise	°C	0
M	multiplicity factor	—	1
OFF	Set to 1 to initialize device to OFF instead of normally	—	0
SW_ET	switch for self-heating: 0=no and 1=yes	—	1
SW_NOISE	switch for including noise: 0=no and 1=yes	—	1
TRISE	local temperature delta to ambient (before self-heating)	°C	0

Table 2-72. VBIC 1.3 4T Device Model Parameters

Parameter	Description	Units	Default
ABK	SiGe base current kink exponent	—	1
AFN	b-e flicker noise current exponent	—	1
AJC	b-c capacitance smoothing factor	—	-0.5
AJE	b-e capacitance smoothing factor	—	-0.5
AJS	c-s capacitance smoothing factor	—	-0.5
ART	smoothing parameter for reach-through	—	0.1
AVC1	b-c weak avalanche parameter 1	V ⁻¹	0
AVC2	b-c weak avalanche parameter 2	—	0
AVCX1	bx-cx weak avalanche parameter 1	V ⁻¹	0
AVCX2	bx-cx weak avalanche parameter 2	—	0
BBK	SiGe base current kink current factor	A	0
BFN	b-e flicker noise 1/f exponent	—	1
CBCO	extrinsic b-c overlap capacitance	F	0
CBEO	extrinsic b-e overlap capacitance	F	0
CCSO	extrinsic c-s overlap capacitance	F	0
CJC	zero-bias b-c depletion capacitance	F	0
CJCP	zero-bias extrinsic c-s depletion capacitance	F	0
CJE	zero-bias b-e depletion capacitance	F	0
CJEP	zero-bias extrinsic b-c depletion capacitance	F	0
CTH	thermal capacitance	—	0
DEAR	delta activation energy for isrr	V	0
EA	activation energy for is	V	1.12
EAIC	activation energy for ibci and ibeip	V	1.12
EAIE	activation energy for ibei	V	1.12

Table 2-72. VBIC 1.3 4T Device Model Parameters

Parameter	Description	Units	Default
EAIS	activation energy for ibcip	V	1.12
EANC	activation energy for ibcn and ibenp	V	1.12
EANE	activation energy for iben	V	1.12
EANS	activation energy for ibcnp	V	1.12
EAP	activation energy for isp	V	1.12
FC	forward bias depletion capacitance limit	—	0.9
GAMM	epi doping parameter	—	0
GMIN	minimum conductance	Ω^{-1}	1e-12
HRCF	high current collector resistance factor	—	0
IBBE	b-e breakdown current	A	1e-06
IBCI	ideal b-c saturation current	A	1e-16
IBCIP	ideal parasitic b-c saturation current	A	0
IBCN	non-ideal b-c saturation current	A	0
IBCNP	non-ideal parasitic b-c saturation current	A	0
IBEI	ideal b-e saturation current	A	1e-18
IBEIP	ideal parasitic b-e saturation current	A	0
IBEN	non-ideal b-e saturation current	A	0
IBENP	non-ideal parasitic b-e saturation current	A	0
IBK0	SiGe base current kink current reference	A	0
IKF	forward knee current (zero=infinite)	A	0
IKP	parasitic knee current (zero=infinite)	A	0
IKR	reverse knee current (zero=infinite)	A	0
IS	transport saturation current	A	1e-16
ISP	parasitic transport saturation current	A	0
ISRR	ratio of is(reverse) to is(forward)	—	1
ITF	tf coefficient of Ic dependence	A	0
KFN	b-e flicker noise constant	—	0
MAXEXP	argument at which to linearize general exponentials	—	1e+22
MC	b-c grading coefficient	—	0.33
MCX	bx-cx grading coefficient for avalanche	—	0.33
ME	b-e grading coefficient	—	0.33
MS	c-s grading coefficient	—	0.33
NBBE	b-e breakdown emission coefficient	—	1
NCI	ideal b-c emission coefficient	—	1
NCIP	ideal parasitic b-c emission coefficient	—	1
NCN	non-ideal b-c emission coefficient	—	2

Table 2-72. VBIC 1.3 4T Device Model Parameters

Parameter	Description	Units	Default
NCNP	non-ideal parasitic b-c emission coefficient	—	2
NEI	ideal b-e emission coefficient	—	1
NEN	non-ideal b-e emission coefficient	—	2
NF	fwd emission coefficient (ideality factor)	—	1
NFP	parasitic emission coeff (ideality factor)	—	1
NKF	high current beta roll-off parameter	—	0.5
NPN	nnp transistor type	—	0
NR	rev emission coefficient (ideality factor)	—	1
OFF	Set to 1 to initialize device to OFF instead of normally	—	0
PC	b-c built-in potential	V	0.75
PE	b-e built-in potential	V	0.75
PNJMAXI	current at which to linearize diode currents	A	1
PNP	pnnp transistor type	—	0
PS	c-s built-in potential	V	0.75
QBM	base charge model selection switch: 0=GP and 1=SGP	—	0
QCO	epi charge parameter	C	0
QNIBEIR	ideal b-e quasi-neutral base recombination parameter	—	0
QTF	variation of tf with base-width modulation	—	0
RBI	intrinsic base resistance	Ω	0
RBP	parasitic transistor base resistance	Ω	0
RBX	extrinsic base resistance	Ω	0
RCI	intrinsic collector resistance	Ω	0
RCX	extrinsic collector resistance	Ω	0
RE	extrinsic emitter resistance	Ω	0
RS	extrinsic substrate resistance	Ω	0
RTH	thermal resistance	—	0
SCALE	scale factor for instance geometries	—	1
SHRINK	shrink percentage for instance geometries	—	0
TAVC	temperature exponent of avc2	$^{\circ}\text{C}^{-1}$	0
TAVCX	temperature exponent of avcx2	$^{\circ}\text{C}^{-1}$	0
TCRTH	temperature exponent of rth	$^{\circ}\text{C}^{-1}$	0
TCVEF	temperature exponent of vef	$^{\circ}\text{C}^{-1}$	0
TCVER	temperature exponent of ver	$^{\circ}\text{C}^{-1}$	0
TD	forward excess-phase delay time	s	0
TF	forward transit time	s	0
TMAX	maximum ambient temperature	$^{\circ}\text{C}$	500

Table 2-72. VBIC 1.3 4T Device Model Parameters

Parameter	Description	Units	Default
TMAXCLIP	clip maximum temperature	°C	500
TMIN	minimum ambient temperature	°C	-100
TMINCLIP	clip minimum temperature	°C	-100
TNBBE	temperature coefficient of nbbe	°C ⁻¹	0
TNF	temperature exponent of nf and nr	°C ⁻¹	0
TNOM	nominal (reference) temperature	°C	27
TR	reverse transit time	s	0
TVBBE1	linear temperature coefficient of vbbe	°C ⁻¹	0
TVBBE2	quadratic temperature coefficient of vbbe	—	0
TYPE	transistor type: -1=npn and +1=pnp (overridden by npn or pnp)	—	-1
VBBE	b-e breakdown voltage	V	0
VEF	forward Early voltage (zero=infinite)	V	0
VER	reverse Early voltage (zero=infinite)	V	0
VO	epi drift saturation voltage	V	0
VPTE	SiGe base current kink voltage	V	0
VRT	reach-through voltage for Cbc limiting	V	0
VTF	tf coefficient of Vbci dependence	V	0
WBE	partitioning of Ibe/Ibex and Qbe/Qbex	—	1
WSP	partitioning of Iccp between Vbep and Vbci	—	1
XII	temperature exponent of ibei, ibci, ibeip, ibcip	—	3
XIKF	temperature exponent of ikf	—	0
XIN	temperature exponent of iben, ibcn, ibenp, ibcnp	—	3
XIS	temperature exponent of is	—	3
XISR	temperature exponent for isrr	—	0
XRBI	temperature exponent of rbi (overrides xrb)	—	0
XRBP	temperature exponent of rbp (overrides xrc)	—	0
XRBI	temperature exponent of rbi (overrides xrb)	—	0
XRC	temperature exponent of rci and rcx and rbp	—	0
XRCI	temperature exponent of rci (overrides xrc)	—	0
XRCX	temperature exponent of rcx (overrides xrc)	—	0
XRE	temperature exponent of re	—	0
XRS	temperature exponent of rs	—	0
XTF	tf bias dependence coefficient	—	0
XVO	temperature exponent of vo	—	0

2.3.17.5. Level 23 BJT Tables (FBH HBT_X)

Table 2-73. FBH HBT_X v2.1 Device Instance Parameters

Parameter	Description	Units	Default
L	Length of emitter fingers	m	3e-05
N	Number of emitter fingers	–	1
TEMP	Device operating temperature	°C	25
W	Width of emitter fingers	m	3e-06

Table 2-74. FBH HBT_X v2.1 Device Model Parameters

Parameter	Description	Units	Default
AHC		–	0
BF		–	100
BR		–	1
BVCEO		–	0
BVEBO		–	0
CJC		–	1e-15
CJE		–	1e-15
CMIN		–	1e-16
CPB		–	0
CPC		–	0
CQ		–	0
CTH		–	7e-07
DEBUG		–	0
DEBUGPLUS		–	0
IKF		–	0
IKR		–	0
J0		–	0.001
JK		–	0.0004
JSC		–	0
JSE		–	0
JSEE		–	0
JSF		–	2e-23
JSR		–	2e-17
KBETA		–	0
KC		–	0
KJC		–	1

Table 2-74. FBH HBT_X v2.1 Device Model Parameters

Parameter	Description	Units	Default
L	Length of emitter fingers	m	3e-05
LB		–	0
LC		–	0
LE		–	0
MC		–	0
MJC		–	0.5
MJE		–	0.5
MODE		–	1
N	Number of emitter fingers	–	1
NC		–	0
NE		–	0
NEE		–	0
NF		–	1
NOISE		–	1
NR		–	1
RB		–	1
RB2		–	1
RBBXX		–	1e+06
RBXX		–	1e+06
RC		–	1
RCI0		–	0.001
RCXX		–	1e+06
RE		–	1
RJK		–	0.001
RTH		–	0.1
TEMP	Device operating temperature	°C	25
TF		–	1e-12
TFT		–	0
THCS		–	0
TNOM		–	20
TR		–	1e-15
TRX		–	1e-15
VAF		–	0
VAR		–	0
VCES		–	0.001
VG		–	1.3

Table 2-74. FBH HBT_X v2.1 Device Model Parameters

Parameter	Description	Units	Default
VGB		–	0
VGBB		–	0
VGC		–	0
VGR		–	0
VJC		–	1.3
VJE		–	1.3
W	Width of emitter fingers	m	3e-06
XCJC		–	0.5
XJ0		–	1

2.3.17.6. Level 230 BJT Tables (HICUM/L0)

The HICUM/L0 device supports output of the internal variables in table 2-77 on the .PRINT line of a netlist. To access them from a print line, use the syntax N(<instance>:<variable>) where “<instance>” refers to the name of the specific HICUM/L0 Q device in your netlist.

Table 2-75. HICUM L0 v1.32 Device Instance Parameters

Parameter	Description	Units	Default
DT	Temperature change for particular transistor	–	0

Table 2-76. HICUM L0 v1.32 Device Model Parameters

Parameter	Description	Units	Default
AF	flicker noise exponent factor	–	2
AHC	Smoothing factor for current dependence	–	0.1
AHQ	Smoothing factor for the d.c. injection width	–	0
AJE	Ratio of maximum to zero-bias value	–	2.5
AJEDC	BE capacitance ratio Ratio maximum to zero-bias value for d.c. transfer current	–	2.5
ALCES	Relative TC of vces	–	0
ALEAV	TC of avalanche exponential factor	–	0
ALIQFH	Frist-order TC of iqfh	–	0
ALIT	Factor for additional delay time of transfer current	–	0.333
ALKAV	TC of avalanche prefactor	–	0
ALQF	Factor for additional delay time of minority charge	–	0.167
ALT0	Frist-order TC of tf0	–	0
ALVS	Relative TC of satur.drift velocity	–	0
AVER	bias dependence for reverse Early voltage	–	0
CBCPAR	Collector-base isolation (overlap) capacitance	–	0
CBEPAR	Emitter-base oxide capacitance	–	0
CJCI0	Total zero-bias BC depletion capacitance	–	1e-20
CJCX0	Zero-bias external BC depletion capacitance	–	1e-20
CJE0	Zero-bias BE depletion capacitance	–	1e-20
CJS0	Zero-bias SC depletion capacitance	–	1e-20
CTH	Thermal capacitance	–	0
DT0H		–	0
DVGBE	Bandgap difference between base and BE-junction	–	0
EAVL	Exponent factor	–	0
F1VG	Coefficient K1 in T-dependent bandgap equation	–	- 0.000102377

Table 2-76. HICUM L0 v1.32 Device Model Parameters

Parameter	Description	Units	Default
F2VG	Coefficient K2 in T-dependent bandgap equation	–	0.00043215
FBC	Split factor = C_{jci0}/C_{jc0}	–	1
FGEO	Geometry factor	–	0.656
FIQF	flag for turning on base related critical current	–	0
FLNQS	Flag for turning on and off of vertical NQS effect	–	0
FLSH	Flag for self-heating calculation	–	0
GTE	Exponent factor for emitter transit time	–	1
IBCS	BC saturation current	–	0
IBES	BE saturation current	–	1e-18
IQF	forward d.c. high-injection roll-off current	–	1e+06
IQFH	high-injection correction current	–	1e+06
IQR	inverse d.c. high-injection roll-off current	–	1e+06
IRES	BE recombination saturation current	–	0
IS	(Modified) saturation current	–	1e-16
ISCS	SC saturation current	–	0
IT_MOD	Flag for using third order solution for transfer current	–	0
ITSS	Substrate transistor transfer saturation current	–	0
KAVL	Prefactor	–	0
KF	flicker noise coefficient	–	0
KIQFH	Second-order TC of iqfh	–	0
KT0	Second-order TC of tf0	–	0
MBC	BC non-ideality factor	–	1
MBE	BE non-ideality factor	–	1
MCF	Non-ideality coefficient of forward collector current	–	1
MCR	Non-ideality coefficient of reverse collector current	–	1
MRE	BE recombination non-ideality factor	–	2
MSC	SC non-ideality factor	–	1
MSF	Substrate transistor transfer current non-ideality factor	–	1
RBI0	Internal base resistance at zero-bias	–	0
RBX	External base series resistance	–	0
RCI0	Low-field collector resistance under emitter	–	150
RCX	Emitter series resistance	–	0
RE	External collector series resistance	–	0
RTH	Thermal resistance	–	0
T0	low current transit time at $V_{bici}=0$	–	0
TBVL	SCR width modulation contribution	–	0

Table 2-76. HICUM L0 v1.32 Device Model Parameters

Parameter	Description	Units	Default
TEF0	Storage time in neutral emitter	–	0
TEF_TEMP	Flag for turning temperature dependence of tef0 on and off	–	1
TFH	high-injection correction factor	–	0
THCS	Saturation time at high current densities	–	0
TNOM	Temperature for which parameters are valid	–	27
TR	Storage time at inverse operation	–	0
TYPE	For transistor type NPN(+1) or PNP (-1)	–	1
VCES	Saturation voltage	–	0.1
VDCI	BC built-in voltage	–	0.7
VDCX	External BC built-in voltage	–	0.7
VDE	BE built-in voltage	–	0.9
VDEDC	BE charge built-in voltage for d.c. transfer current	–	0.9
VDS	SC built-in voltage	–	0.3
VEF	forward Early voltage (normalization volt.)	–	1e+06
VER	reverse Early voltage (normalization volt.)	–	1e+06
VGB	Bandgap-voltage	–	1.2
VGC	Effective collector bandgap-voltage	–	1.17
VGE	Effective emitter bandgap-voltage	–	1.17
VGS	Effective substrate bandgap-voltage	–	1.17
VLIM	Voltage dividing ohmic and satur.region	–	0.5
VPT	Punch-through voltage	–	100
VPTCI	Punch-through voltage of BC junction	–	100
VPTCX	Punch-through voltage	–	100
VPTS	SC punch-through voltage	–	100
VR0C	forward Early voltage (normalization volt.)	–	1e+06
VR0E	forward Early voltage (normalization volt.)	–	2.5
ZCI	BC exponent factor	–	0.333
ZCX	External BC exponent factor	–	0.333
ZE	BE exponent factor	–	0.5
ZEDC	charge BE exponent factor for d.c. transfer current	–	0.5
ZETABET	Exponent coefficient in BE junction current temperature dependence	–	3.5
ZETACI	TC of epi-collector diffusivity	–	0
ZETACT	Exponent coefficient in transfer current temperature dependence	–	3
ZETAIQF	TC of iqf	–	0

Table 2-76. HICUM L0 v1.32 Device Model Parameters

Parameter	Description	Units	Default
ZETARBI	TC of internal base resistance	–	0
ZETARBX	TC of external base resistance	–	0
ZETARCX	TC of external collector resistance	–	0
ZETARE	TC of emitter resistances	–	0
ZETARTH	Exponent factor for temperature dependent thermal resistance	–	0
ZETAVER	TC of Reverse Early voltage	–	-1
ZETAVGBE	TC of AVER	–	1
ZS	External SC exponent factor	–	0.3

Table 2-77. BJT level 230 Output Variables

Parameter	Description	Units	Default
qjci	B-C internal junction charge	C	none
qjei	B-E internal junction charge	C	none
it	Transfer Current	A	none
ijbc	Base-collector diode current	A	none
iavl	Avalanche current	A	none
ijsc	Substrate-collector diode current	A	none
Ibici	Base-collector diode current minus the avalanche current	A	none
ijbe	Base-emitter diode current	A	none
IAVL	Avalanche current	A	none
VBE	External BE voltage	V	none
VBC	External BC voltage	V	none
VCE	External CE voltage	V	none
VSC	External SC voltage	V	none
Gmi	Internal transconductance	Ω^{-1}	none
RPIi	Internal input resistance	Ohm	none
RMUi	Internal feedback resistance	Ohm	none
ROi	Internal Output resistance	Ohm	none
CPIi	Total BE capacitance	F	none
CMUi	Total internal BC capacitance	F	none
CBCX	Total external BC capacitance	F	none
CCS	CS junction capacitance	F	none
RBi	Internal base resistance	Ohm	none

Table 2-77. BJT level 230 Output Variables

Parameter	Description	Units	Default
RB	Total base resistance	Ohm	none
RCX	External (saturated) collector series resistance	Ohm	none
RE	Emitter series resistance	Ohm	none
BETAAC	Small signal current gain	–	none
TF	Total forward transit time	s	none
FT	Transit frequency	Hz	none

2.3.17.7. Level 234 BJT Table (HICUM/L2)

NOTE: The HICUM/L2 model has no instance parameters. The HICUM/L2 device supports output of the internal variables in table 2-79 on the .PRINT line of a netlist. To access them from a print line, use the syntax N(<instance>:<variable>) where “<instance>” refers to the name of the specific HICUM/L2 Q device in your netlist.

Table 2-78. HICUM v2.4.0 Device Model Parameters

Parameter	Description	Units	Default
ABET	Exponent factor for tunneling current	–	40
ACBAR	Smoothing parameter for barrier voltage	–	0.01
AF	Flicker noise exponent factor	–	2
AFRE	Emitter resistance flicker noise exponent factor	–	2
AHC	Smoothing factor for current dependence of base and collector transit time	–	0.1
AHJEI	Parameter describing the slope of $h_{jEi}(V_{BE})$	–	0
AICK	Smoothing term for ICK	–	0.001
AJEI	Ratio of maximum to zero-bias value of internal B-E capacitance	–	2.5
AJEP	Ratio of maximum to zero-bias value of peripheral B-E capacitance	–	2.5
ALB	Relative TC of forward current gain for V2.1 model	–	0
ALCES	Relative TC of VCES	–	0
ALFAV	Relative TC for FAVL	–	0
ALIT	Factor for additional delay time of transfer current	–	0.333
ALKAV	Relative TC for KAVL	–	0
ALQAV	Relative TC for QAVL	–	0
ALQF	Factor for additional delay time of minority charge	–	0.167
ALRTH	First order relative TC of parameter Rth	–	0
ALT0	First order relative TC of parameter T0	–	0
ALVS	Relative TC of saturation drift velocity	–	0
C10	GICCR constant	–	2e-30
CBCPAR	Total parasitic B-C capacitance	–	0
CBEPAR	Total parasitic B-E capacitance	–	0
CFBE	Flag for determining where to tag the flicker noise source	–	-1
CJCI0	Internal B-C zero-bias depletion capacitance	–	1e-20
CJCX0	External B-C zero-bias depletion capacitance	–	1e-20
CJEI0	Internal B-E zero-bias depletion capacitance	–	1e-20
CJEP0	Peripheral B-E zero-bias depletion capacitance	–	1e-20

Table 2-78. HICUM v2.4.0 Device Model Parameters

Parameter	Description	Units	Default
CJS0	C-S zero-bias depletion capacitance	–	0
CSCP0	Perimeter S-C zero-bias depletion capacitance	–	0
CSU	Substrate shunt capacitance	–	0
CTH	Thermal capacitance	–	0
DELCK	Fitting factor for critical current	–	2
DT	Temperature change w.r.t. chip temperature for particular transistor	–	0
DT0H	Time constant for base and B-C space charge layer width modulation	–	0
DVGBE	Bandgap difference between B and B-E junction used for $h_j E_{i0}$ and $h_f 0$	–	0
F1VG	Coefficient K1 in T-dependent band-gap equation	–	- 0.000102377
F2VG	Coefficient K2 in T-dependent band-gap equation	–	0.00043215
FAVL	Avalanche current factor	–	0
FBCPAR	Partitioning factor of parasitic B-C cap	–	0
FBEPAR	Partitioning factor of parasitic B-E cap	–	1
FCRBI	Ratio of HF shunt to total internal capacitance (lateral NQS effect)	–	0
FDQR0	Correction factor for modulation by B-E and B-C space charge layer	–	0
FGEO	Factor for geometry dependence of emitter current crowding	–	0.6557
FLCOMP	Flag for compatibility with v2.1 model (0=v2.1)	–	0
FLCONO	Flag for turning on and off of correlated noise implementation	–	0
FLNQS	Flag for turning on and off of vertical NQS effect	–	0
FLSH	Flag for turning on and off self-heating effect	–	0
FQI	Ration of internal to total minority charge	–	1
FTHC	Partitioning factor for base and collector portion	–	0
GTFE	Exponent factor for current dependence of neutral emitter storage time	–	1
HF0	Weight factor for the low current minority charge	–	1
HFC	Collector minority charge weighting factor in HBTs	–	1
HFE	Emitter minority charge weighting factor in HBTs	–	1
HJCI	B-C depletion charge weighting factor in HBTs	–	1
HJEI	B-E depletion charge weighting factor in HBTs	–	1
IBCIS	Internal B-C saturation current	–	1e-16

Table 2-78. HICUM v2.4.0 Device Model Parameters

Parameter	Description	Units	Default
IBCXS	External B-C saturation current	–	0
IBEIS	Internal B-E saturation current	–	1e-18
IBEPS	Peripheral B-E saturation current	–	0
IBETS	B-E tunneling saturation current	–	0
ICBAR	Normalization parameter	–	0
ICH	High-current correction for 2D and 3D effects	–	0
IREIS	Internal B-E recombination saturation current	–	0
IREPS	Peripheral B-E recombination saturation current	–	0
ISCS	C-S diode saturation current	–	0
ITSS	Substrate transistor transfer saturation current	–	0
KAVL	Flag/factor for turning strong avalanche on	–	0
KF	Flicker noise coefficient	–	0
KFRE	Emitter resistance flicker noise coefficient	–	0
KT0	Second order relative TC of parameter T0	–	0
LATB	Scaling factor for collector minority charge in direction of emitter width	–	0
LATL	Scaling factor for collector minority charge in direction of emitter length	–	0
MBCI	Internal B-C current ideality factor	–	1
MBCX	External B-C current ideality factor	–	1
MBEI	Internal B-E current ideality factor	–	1
MBEP	Peripheral B-E current ideality factor	–	1
MCF	Non-ideality factor for III-V HBTs	–	1
MREI	Internal B-E recombination current ideality factor	–	2
MREP	Peripheral B-E recombination current ideality factor	–	2
MSC	Ideality factor of C-S diode current	–	1
MSF	Forward ideality factor of substrate transfer current	–	1
QAVL	Exponent factor for avalanche current	–	0
QP0	Zero-bias hole charge	–	2e-14
RBI0	Zero bias internal base resistance	–	0
RBX	External base series resistance	–	0
RCI0	Internal collector resistance at low electric field	–	150
RCX	External collector series resistance	–	0
RE	Emitter series resistance	–	0
RHJEI	Smoothing parameter for $h_j E_i(V_{BE})$ at high voltage	–	1
RSU	Substrate series resistance	–	0

Table 2-78. HICUM v2.4.0 Device Model Parameters

Parameter	Description	Units	Default
RTH	Thermal resistance	–	0
T0	Low current forward transit time at VBC=0V	–	0
TBHREC	Base current recombination time constant at B-C barrier for high forward injection	–	0
TBVL	Time constant for modeling carrier jam at low VCE	–	0
TEF0	Neutral emitter storage time	–	0
THCS	Saturation time constant at high current densities	–	0
TNOM	Temperature at which parameters are specified	–	27
TR	Storage time for inverse operation	–	0
TSF	Transit time for forward operation of substrate transistor	–	0
TUNODE	Specifies the base node connection for the tunneling current	–	1
TYPE	For transistor type NPN(+1) or PNP (-1)	–	1
VCBAR	Barrier voltage	–	0
VCES	Internal C-E saturation voltage	–	0.1
VDCI	Internal B-C built-in potential	–	0.7
VDCX	External B-C built-in potential	–	0.7
VDEI	Internal B-E built-in potential	–	0.9
VDEP	Peripheral B-E built-in potential	–	0.9
VDS	C-S built-in potential	–	0.6
VDSP	Perimeter S-C built-in potential	–	0.6
VGB	Bandgap voltage extrapolated to 0 K	–	1.17
VGC	Effective collector bandgap voltage	–	1.17
VGE	Effective emitter bandgap voltage	–	1.17
VGS	Effective substrate bandgap voltage	–	1.17
VLIM	Voltage separating ohmic and saturation velocity regime	–	0.5
VPT	Collector punch-through voltage	–	100
VPTCI	Internal B-C punch-through voltage	–	100
VPTCX	External B-C punch-through voltage	–	100
VPTS	C-S punch-through voltage	–	100
VPTSP	Perimeter S-C punch-through voltage	–	100
ZCI	Internal B-C grading coefficient	–	0.4
ZCX	External B-C grading coefficient	–	0.4
ZEI	Internal B-E grading coefficient	–	0.5
ZEP	Peripheral B-E grading coefficient	–	0.5

Table 2-78. HICUM v2.4.0 Device Model Parameters

Parameter	Description	Units	Default
ZETABET	Exponent coefficient in B-E junction current temperature dependence	–	3.5
ZETACI	Temperature exponent for RCI0	–	0
ZETACT	Exponent coefficient in transfer current temperature dependence	–	3
ZETACX	Temperature exponent of mobility in substrate transistor transit time	–	1
ZETAHJEI	Temperature coefficient for ahjEi	–	1
ZETARBI	Temperature exponent of internal base resistance	–	0
ZETARBX	Temperature exponent of external base resistance	–	0
ZETARCX	Temperature exponent of external collector resistance	–	0
ZETARE	Temperature exponent of emitter resistance	–	0
ZETARTH	Temperature coefficient for Rth	–	0
ZETA VGBE	Temperature coefficient for hjEi0	–	1
ZS	C-S grading coefficient	–	0.5
ZSP	Perimeter S-C grading coefficient	–	0.5

Table 2-79. BJT level 234 Output Variables

Parameter	Description	Units	Default
rcx_t	External (saturated) collector series resistance	Ohm	none
re_t	Emitter series resistance	Ohm	none
rbi	Internal base resistance as calculated in the model	Ohm	none
rb	Total base resistance as calculated in the model	Ohm	none
IAVL	Avalanche current	A	none
VBE	External BE voltage	V	none
VBC	External BC voltage	V	none
VCE	External CE voltage	V	none
VSC	External SC voltage	V	none
Gmi	Internal transconductance	A/V	none
GMS	Transconductance of the parasitic substrate PNP	A/V	none
RPIi	Internal base-emitter (input) resistance	Ohm	none
RPIx	External base-emitter (input) resistance	Ohm	none
RMUi	Internal feedback resistance	Ohm	none
RMUx	External feedback resistance	Ohm	none
ROi	Output resistance	Ohm	none
CPIi	Total internal BE capacitance	F	none

Table 2-79. BJT level 234 Output Variables

Parameter	Description	Units	Default
CPIx	Total external BE capacitance	F	none
CMUi	Total internal BC capacitance	F	none
CMUx	Total external BC capacitance	F	none
CCS	CS junction capacitance	F	none
BETAAC	Small signal current gain	–	none
CRBI	Shunt capacitance across RBI as calculated in the model	F	none
TF	Forward transit time	s	none
FT	Transit frequency	Hz	none
TK	Actual device temperature	K	none
DTSH	Temperature increase due to self-heating	K	none

2.3.17.8. Level 504 and 505 BJT Tables (MEXTRAM)

The MEXTRAM device supports output of the internal variables in tables 2-82 and 2-82 on the .PRINT line of a netlist. To access them from a print line, use the syntax N(<instance>:<variable>) where “<instance>” refers to the name of the specific MEXTRAM Q device in your netlist.

Table 2-80. MEXTRAM 504.12.1 Device Instance Parameters

Parameter	Description	Units	Default
M	Alias for MULT	—	1
MULT	Multiplication factor	—	1

Table 2-81. MEXTRAM 504.12.1 Device Model Parameters

Parameter	Description	Units	Default
AB	Temperature coefficient of the resistivity of the base	—	1
AC	Temperature coefficient of the resistivity of the collector contact	—	2
ACBL	Temperature coefficient of the resistivity of the collector buried layer	—	2
AE	Temperature coefficient of the resistivity of the emitter	—	0
AEPI	Temperature coefficient of the resistivity of the epilayer	—	2.5
AEX	Temperature coefficient of the resistivity of the extrinsic base	—	0.62
AF	Exponent of the Flicker-noise	—	2
AQBO	Temperature coefficient of the zero-bias base charge	—	0.3
AS	Substrate temperature coefficient	—	1.58
ASUB	Temperature coefficient for mobility of minorities in the substrate	—	2
AVGEB	Temperature coefficient band-gap voltage for Zener effect emitter-base junction	—	0.000473
AXI	Smoothness parameter for the onset of quasi-saturation	—	0.3
BF	Ideal forward current gain	—	215
BRI	Ideal reverse current gain	—	7
CBCO	Collector-base overlap capacitance	—	0
CBE0	Emitter-base overlap capacitance	—	0
CJC	Zero-bias collector-base depletion capacitance	—	7.8e-14
CJE	Zero-bias emitter-base depletion capacitance	—	7.3e-14
CJS	Zero-bias collector-substrate depletion capacitance	—	3.15e-13

Table 2-81. MEXTRAM 504.12.1 Device Model Parameters

Parameter	Description	Units	Default
DAIS	Fine tuning of temperature dependence of C-E saturation current	—	0
DEG	Bandgap difference over the base	—	0
DTA	Difference between the local and global ambient temperatures	—	0
DVGBF	Band-gap voltage difference of the forward current gain	—	0.05
DVGBR	Band-gap voltage difference of the reverse current gain	—	0.045
DVGTE	Band-gap voltage difference of emitter stored charge	—	0.05
EXAVL	Flag for extended modeling of avalanche currents	—	0
EXMOD	Flag for extended modeling of the reverse current gain	—	1
EXPHI	Flag for the distributed high-frequency effects in transient	—	1
EXSUB	Flag for extended modelling of substrate currents	—	0
FTAUN	Fraction of noise transit time to total transit time	—	0
GMIN	Minimum conductance	—	1e-13
IBF	Saturation current of the non-ideal forward base current	—	2.7e-15
IBR	Saturation current of the non-ideal reverse base current	—	1e-15
ICSS	Collector-substrate ideal saturation current	—	-1
IHC	Critical current for velocity saturation in the epilayer	—	0.004
IK	Collector-emitter high injection knee current	—	0.1
IKS	Base-substrate high injection knee current	—	0.00025
IS	Collector-emitter saturation current	—	2.2e-17
ISS	Base-substrate saturation current	—	4.8e-17
IZEB	Pre-factor of emitter-base Zener tunneling current	—	0
KAVL	Switch for white noise contribution due to avalanche	—	0
KC	Switch for RF correlation noise model selection	—	0
KE	Fraction of QE in excess phase shift	—	0
KF	Flicker-noise coefficient of the ideal base current	—	2e-11
KFN	Flicker-noise coefficient of the non-ideal base current	—	2e-11
LEVEL	Model level	—	504
M	Alias for MULT	—	1
MC	Coefficient for current modulation of CB depletion capacitance	—	0.5
MLF	Non-ideality factor of the non-ideal forward base current	—	2

Table 2-81. MEXTRAM 504.12.1 Device Model Parameters

Parameter	Description	Units	Default
MTAU	Non-ideality factor of the emitter stored charge	—	1
MULT	Multiplication factor	—	1
NZEB	Coefficient of emitter-base Zener tunneling current	—	22
PC	Collector-base grading coefficient	—	0.5
PE	Emitter-base grading coefficient	—	0.4
PS	Collector-substrate grading coefficient	—	0.34
RBC	Constant part of the base resistance	—	23
RBV	Zero-bias value of the variable part of the base resistance	—	18
RCBLI	Resistance Collector Buried Layer Intrinsic	—	0
RCBLX	Resistance Collector Buried Layer eXtrinsic	—	0
RCC	Constant part of the collector resistance	—	12
RCV	Resistance of the un-modulated epilayer	—	150
RE	Emitter resistance	—	5
SCRCV	Space charge resistance of the epilayer	—	1250
SFH	Current spreading factor of avalanche model when EXAVL=1	—	0.3
TAUB	Transit time of stored base charge	—	4.2e-12
TAUE	Minimum transit time of stored emitter charge	—	2e-12
TAUR	Transit time of reverse extrinsic stored base charge	—	5.2e-10
TEPI	Transit time of stored epilayer charge	—	4.1e-11
TREF	Reference temperature	—	25
TVGEB	Temperature coefficient band-gap voltage for Zener effect emitter-base junction	—	636
TYPE	Flag for NPN (1) or PNP (-1) transistor type	—	1
VAVL	Voltage determining curvature of avalanche current	—	3
VDC	Collector-base diffusion voltage	—	0.68
VDE	Emitter-base diffusion voltage	—	0.95
VDS	Collector-substrate diffusion voltage	—	0.62
VEF	Forward Early voltage	—	44
VER	Reverse Early voltage	—	2.5
VGB	Band-gap voltage of the base	—	1.17
VGC	Band-gap voltage of the collector	—	1.18
VGJ	Band-gap voltage recombination emitter-base junction	—	1.15
VGS	Band-gap voltage of the substrate	—	1.2
VGZEB	Band-gap voltage at Tref of Zener effect emitter-base junction	—	1.15

Table 2-81. MEXTRAM 504.12.1 Device Model Parameters

Parameter	Description	Units	Default
VLR	Cross-over voltage of the non-ideal reverse base current	—	0.2
WAVL	Epilayer thickness used in weak-avalanche model	—	1.1e-06
XCJC	Fraction of CB depletion capacitance under the emitter	—	0.032
XCJE	Sidewall fraction of the emitter-base depletion capacitance	—	0.4
XEXT	Part of currents and charges that belong to extrinsic region	—	0.63
XIBI	Part of ideal base current that belongs to the sidewall	—	0
XP	Constant part of Cjc	—	0.35
XQB	Emitter-fraction of base diffusion charge	—	0.333333
XREC	Pre-factor of the recombination part of Ib1	—	0

Table 2-82. BJT level 504 Output Variables

Parameter	Description	Units	Default
OP_ic	External DC collector current	A	none
OP_ib	External DC base current	A	none
OP_betadc	External DC current gain Ic/Ib		none
OP_ie	External DC emitter current	A	none
OP_vbe	External base-emitter bias	V	none
OP_vce	External collector-emitter bias	V	none
OP_vbc	External base-collector bias	V	none
OP_is	External DC substrate current	A	none
OP_vse	External substrate-emitter bias	V	none
OP_vbs	External base-substrate bias	V	none
OP_vsc	External substrate-collector bias	V	none
OP_vb2e1	Internal base-emitter bias	V	none
OP_vb2c2	Internal base-collector bias	V	none
OP_vb2c1	Internal base-collector bias including epilayer	V	none
OP_vb1c1	External base-collector bias without contact resistances	V	none
OP_vc4c1	Bias over intrinsic buried layer	V	none
OP_vc3c4	Bias over extrinsic buried layer	V	none
OP_ve1e	Bias over emitter resistance	V	none
OP_in	Main current	A	none

Table 2-82. BJT level 504 Output Variables

Parameter	Description	Units	Default
OP_ic1c2	Epilayer current	A	none
OP_ib1b2	Pinched-base current	A	none
OP_ib1	Ideal forward base current	A	none
OP_sib1	Ideal side-wall base current	A	none
OP_izteb	Zener tunneling current in the emitter base junction	A	none
OP_ib2	Non-ideal forward base current	A	none
OP_ib3	Non-ideal reverse base current	A	none
OP_iavl	Avalanche current	A	none
OP_iex	Extrinsic reverse base current	A	none
OP_xiex	Extrinsic reverse base current	A	none
OP_isub	Substrate current	A	none
OP_xisub	Substrate current	A	none
OP_isf	Substrate failure current	A	none
OP_ire	Current through emitter resistance	A	none
OP_irbc	Current through constant base resistance	A	none
OP_ircblx	Current through extrinsic buried layer resistance	A	none
OP_ircbli	Current through intrinsic buried layer resistance	A	none
OP_ircc	Current through collector contact resistance	A	none
OP_qe	Emitter charge or emitter neutral charge	C	none
OP_qte	Base-emitter depletion charge	C	none
OP_sqte	Sidewall base-emitter depletion charge	C	none
OP_qbe	Base-emitter diffusion charge	C	none
OP_qbc	Base-collector diffusion charge	C	none
OP_qtc	Base-collector depletion charge	C	none
OP_qepi	Epilayer diffusion charge	C	none
OP_qb1b2	AC current crowding charge	C	none
OP_qtex	Extrinsic base-collector depletion charge	C	none
OP_xqtex	Extrinsic base-collector depletion charge	C	none
OP_qex	Extrinsic base-collector diffusion charge	C	none
OP_xqex	Extrinsic base-collector diffusion charge	C	none
OP_qts	Collector-substrate depletion charge	C	none
OP_gx	Forward transconductance	Ω^{-1}	none
OP_gy	Reverse transconductance	Ω^{-1}	none
OP_gz	Reverse transconductance	Ω^{-1}	none
OP_sgpi	Conductance sidewall b-e junction	Ω^{-1}	none
OP_gpix	Conductance floor b-e junction	Ω^{-1}	none

Table 2-82. BJT level 504 Output Variables

Parameter	Description	Units	Default
OP_gpiy	Early effect on recombination base current	Ω^{-1}	none
OP_gpiz	Early effect on recombination base current	Ω^{-1}	none
OP_gmux	Early effect on avalanche current limiting	Ω^{-1}	none
OP_gmuy	Conductance of avalanche current	Ω^{-1}	none
OP_gmuz	Conductance of avalanche current	Ω^{-1}	none
OP_gmuex	Conductance of extrinsic b-c junction	Ω^{-1}	none
OP_xgmuey	Conductance of extrinsic b-c junction	Ω^{-1}	none
OP_grcvy	Conductance of epilayer current	Ω^{-1}	none
OP_grcvz	Conductance of epilayer current	Ω^{-1}	none
OP_rbv	Base resistance	Ohm	none
OP_grbvz	Early effect on base resistance	Ω^{-1}	none
OP_grbvy	Early effect on base resistance	Ω^{-1}	none
OP_grbvz	Early effect on base resistance	Ω^{-1}	none
OP_re	Emitter resistance	Ohm	none
OP_rbc	Constant base resistance	Ohm	none
OP_rcc	Collector contact resistance	Ohm	none
OP_rcblx	Extrinsic buried layer resistance	Ohm	none
OP_rcbli	Intrinsic buried layer resistance	Ohm	none
OP_gs	Conductance parasitic PNP transistor	Ω^{-1}	none
OP_xgs	Conductance parasitic PNP transistor	Ω^{-1}	none
OP_gsf	Conductance substrate failure current	Ω^{-1}	none
OP_scbe	Capacitance sidewall b-e junction	F	none
OP_cbex	Capacitance floor b-e junction	F	none
OP_cbey	Early effect on b-e diffusion charge	F	none
OP_cbez	Early effect on b-e diffusion charge	F	none
OP_cbcx	Early effect on b-c diffusion charge	F	none
OP_cbcy	Capacitance floor b-c junction	F	none
OP_cbcz	Capacitance floor b-c junction	F	none
OP_cbcex	Capacitance extrinsic b-c junction	F	none
OP_xcbcex	Capacitance extrinsic b-c junction	F	none
OP_cb1b2	Capacitance AC current crowding	F	none
OP_cb1b2x	Cross-capacitance AC current crowding	F	none
OP_cb1b2y	Cross-capacitance AC current crowding	F	none
OP_cb1b2z	Cross-capacitance AC current crowding	F	none
OP_cts	Capacitance s-c junction	F	none
OP_gm	transconductance	Ω^{-1}	none

Table 2-82. BJT level 504 Output Variables

Parameter	Description	Units	Default
OP_beta	Current amplification		none
OP_gout	Output conductance	Ω^{-1}	none
OP_gmu	Feedback transconductance	Ω^{-1}	none
OP_rb	Base resistance	Ohm	none
OP_rc	Collector resistance	Ohm	none
OP_cbe	Base-emitter capacitance	C	none
OP_cbc	Base-collector capacitance	C	none
OP_ft	Good approximation for cut-off frequency		none
OP_iqs	Current at onset of quasi-saturation	A	none
OP_xiwepi	Thickness of injection layer	m	none
OP_vb2c2star	Physical value of internal base-collector bias	V	none
OP_tk	Actual temperature	K	none

Table 2-83. MEXTRAM 504.12.1 with self heating Device Instance Parameters

Parameter	Description	Units	Default
M	Alias for MULT	—	1
MULT	Multiplication factor	—	1

Table 2-84. MEXTRAM 504.12.1 with self heating Device Model Parameters

Parameter	Description	Units	Default
AB	Temperature coefficient of the resistivity of the base	—	1
AC	Temperature coefficient of the resistivity of the collector contact	—	2
ACBL	Temperature coefficient of the resistivity of the collector buried layer	—	2
AE	Temperature coefficient of the resistivity of the emitter	—	0
AEPI	Temperature coefficient of the resistivity of the epilayer	—	2.5
AEX	Temperature coefficient of the resistivity of the extrinsic base	—	0.62
AF	Exponent of the Flicker-noise	—	2
AQBO	Temperature coefficient of the zero-bias base charge	—	0.3
AS	Substrate temperature coefficient	—	1.58
ASUB	Temperature coefficient for mobility of minorities in the substrate	—	2
ATH	Temperature coefficient of the thermal resistance	—	0
AVGEB	Temperature coefficient band-gap voltage for Zener effect emitter-base junction	—	0.000473
AXI	Smoothness parameter for the onset of quasi-saturation	—	0.3
BF	Ideal forward current gain	—	215
BRI	Ideal reverse current gain	—	7
CBCO	Collector-base overlap capacitance	—	0
CBEO	Emitter-base overlap capacitance	—	0
CJC	Zero-bias collector-base depletion capacitance	—	7.8e-14
CJE	Zero-bias emitter-base depletion capacitance	—	7.3e-14
CJS	Zero-bias collector-substrate depletion capacitance	—	3.15e-13
CTH	Thermal capacitance	—	3e-09
DAIS	Fine tuning of temperature dependence of C-E saturation current	—	0
DEG	Bandgap difference over the base	—	0

Table 2-84. MEXTRAM 504.12.1 with self heating Device Model Parameters

Parameter	Description	Units	Default
DTA	Difference between the local and global ambient temperatures	—	0
DVGBF	Band-gap voltage difference of the forward current gain	—	0.05
DVGBR	Band-gap voltage difference of the reverse current gain	—	0.045
DVGTE	Band-gap voltage difference of emitter stored charge	—	0.05
EXAVL	Flag for extended modeling of avalanche currents	—	0
EXMOD	Flag for extended modeling of the reverse current gain	—	1
EXPHI	Flag for the distributed high-frequency effects in transient	—	1
EXSUB	Flag for extended modelling of substrate currents	—	0
FTAUN	Fraction of noise transit time to total transit time	—	0
GMIN	Minimum conductance	—	1e-13
IBF	Saturation current of the non-ideal forward base current	—	2.7e-15
IBR	Saturation current of the non-ideal reverse base current	—	1e-15
ICSS	Collector-substrate ideal saturation current	—	-1
IHC	Critical current for velocity saturation in the epilayer	—	0.004
IK	Collector-emitter high injection knee current	—	0.1
IKS	Base-substrate high injection knee current	—	0.00025
IS	Collector-emitter saturation current	—	2.2e-17
ISS	Base-substrate saturation current	—	4.8e-17
IZEB	Pre-factor of emitter-base Zener tunneling current	—	0
KAVL	Switch for white noise contribution due to avalanche	—	0
KC	Switch for RF correlation noise model selection	—	0
KE	Fraction of QE in excess phase shift	—	0
KF	Flicker-noise coefficient of the ideal base current	—	2e-11
KFN	Flicker-noise coefficient of the non-ideal base current	—	2e-11
LEVEL	Model level	—	504
M	Alias for MULT	—	1
MC	Coefficient for current modulation of CB depletion capacitance	—	0.5
MLF	Non-ideality factor of the non-ideal forward base current	—	2
MTAU	Non-ideality factor of the emitter stored charge	—	1
MULT	Multiplication factor	—	1
NZEB	Coefficient of emitter-base Zener tunneling current	—	22

Table 2-84. MEXTRAM 504.12.1 with self heating Device Model Parameters

Parameter	Description	Units	Default
PC	Collector-base grading coefficient	—	0.5
PE	Emitter-base grading coefficient	—	0.4
PS	Collector-substrate grading coefficient	—	0.34
RBC	Constant part of the base resistance	—	23
RBV	Zero-bias value of the variable part of the base resistance	—	18
RCBLI	Resistance Collector Buried Layer Intrinsic	—	0
RCBLX	Resistance Collector Buried Layer eXtrinsic	—	0
RCC	Constant part of the collector resistance	—	12
RCV	Resistance of the un-modulated epilayer	—	150
RE	Emitter resistance	—	5
RTH	Thermal resistance	—	300
SCRCV	Space charge resistance of the epilayer	—	1250
SFH	Current spreading factor of avalanche model when EXAVL=1	—	0.3
TAUB	Transit time of stored base charge	—	4.2e-12
TAUE	Minimum transit time of stored emitter charge	—	2e-12
TAUR	Transit time of reverse extrinsic stored base charge	—	5.2e-10
TEPI	Transit time of stored epilayer charge	—	4.1e-11
TREF	Reference temperature	—	25
TVGEB	Temperature coefficient band-gap voltage for Zener effect emitter-base junction	—	636
TYPE	Flag for NPN (1) or PNP (-1) transistor type	—	1
VAVL	Voltage determining curvature of avalanche current	—	3
VDC	Collector-base diffusion voltage	—	0.68
VDE	Emitter-base diffusion voltage	—	0.95
VDS	Collector-substrate diffusion voltage	—	0.62
VEF	Forward Early voltage	—	44
VER	Reverse Early voltage	—	2.5
VGB	Band-gap voltage of the base	—	1.17
VGC	Band-gap voltage of the collector	—	1.18
VGJ	Band-gap voltage recombination emitter-base junction	—	1.15
VGS	Band-gap voltage of the substrate	—	1.2
VGZEB	Band-gap voltage at Tref of Zener effect emitter-base junction	—	1.15
VLR	Cross-over voltage of the non-ideal reverse base current	—	0.2

Table 2-84. MEXTRAM 504.12.1 with self heating Device Model Parameters

Parameter	Description	Units	Default
WAVL	Epilayer thickness used in weak-avalanche model	—	1.1e-06
XCJC	Fraction of CB depletion capacitance under the emitter	—	0.032
XCJE	Sidewall fraction of the emitter-base depletion capacitance	—	0.4
XEXT	Part of currents and charges that belong to extrinsic region	—	0.63
XIBI	Part of ideal base current that belongs to the sidewall	—	0
XP	Constant part of Cjc	—	0.35
XQB	Emitter-fraction of base diffusion charge	—	0.333333
XREC	Pre-factor of the recombination part of Ib1	—	0

Table 2-85. BJT level 505 Output Variables

Parameter	Description	Units	Default
OP_ic	External DC collector current	A	none
OP_ib	External DC base current	A	none
OP_betadc	External DC current gain Ic/Ib		none
OP_ie	External DC emitter current	A	none
OP_vbe	External base-emitter bias	V	none
OP_vce	External collector-emitter bias	V	none
OP_vbc	External base-collector bias	V	none
OP_is	External DC substrate current	A	none
OP_vse	External substrate-emitter bias	V	none
OP_vbs	External base-substrate bias	V	none
OP_vsc	External substrate-collector bias	V	none
OP_vb2e1	Internal base-emitter bias	V	none
OP_vb2c2	Internal base-collector bias	V	none
OP_vb2c1	Internal base-collector bias including epilayer	V	none
OP_vb1c1	External base-collector bias without contact resistances	V	none
OP_vc4c1	Bias over intrinsic buried layer	V	none
OP_vc3c4	Bias over extrinsic buried layer	V	none
OP_ve1e	Bias over emitter resistance	V	none
OP_in	Main current	A	none
OP_ic1c2	Epilayer current	A	none
OP_ib1b2	Pinched-base current	A	none

Table 2-85. BJT level 505 Output Variables

Parameter	Description	Units	Default
OP_ib1	Ideal forward base current	A	none
OP_sib1	Ideal side-wall base current	A	none
OP_izteb	Zener tunneling current in the emitter base junction	A	none
OP_ib2	Non-ideal forward base current	A	none
OP_ib3	Non-ideal reverse base current	A	none
OP_iavl	Avalanche current	A	none
OP_iex	Extrinsic reverse base current	A	none
OP_xiex	Extrinsic reverse base current	A	none
OP_isub	Substrate current	A	none
OP_xisub	Substrate current	A	none
OP_isf	Substrate failure current	A	none
OP_ire	Current through emitter resistance	A	none
OP_irbc	Current through constant base resistance	A	none
OP_ircblx	Current through extrinsic buried layer resistance	A	none
OP_ircbli	Current through intrinsic buried layer resistance	A	none
OP_ircc	Current through collector contact resistance	A	none
OP_qe	Emitter charge or emitter neutral charge	C	none
OP_qte	Base-emitter depletion charge	C	none
OP_sqte	Sidewall base-emitter depletion charge	C	none
OP_qbe	Base-emitter diffusion charge	C	none
OP_qbc	Base-collector diffusion charge	C	none
OP_qtc	Base-collector depletion charge	C	none
OP_qepi	Epilayer diffusion charge	C	none
OP_qb1b2	AC current crowding charge	C	none
OP_qtex	Extrinsic base-collector depletion charge	C	none
OP_xqtex	Extrinsic base-collector depletion charge	C	none
OP_qex	Extrinsic base-collector diffusion charge	C	none
OP_xqex	Extrinsic base-collector diffusion charge	C	none
OP_qts	Collector-substrate depletion charge	C	none
OP_gx	Forward transconductance	Ω^{-1}	none
OP_gy	Reverse transconductance	Ω^{-1}	none
OP_gz	Reverse transconductance	Ω^{-1}	none
OP_sgpi	Conductance sidewall b-e junction	Ω^{-1}	none
OP_gpix	Conductance floor b-e junction	Ω^{-1}	none
OP_gpiy	Early effect on recombination base current	Ω^{-1}	none
OP_gpiz	Early effect on recombination base current	Ω^{-1}	none

Table 2-85. BJT level 505 Output Variables

Parameter	Description	Units	Default
OP_gmux	Early effect on avalanche current limiting	Ω^{-1}	none
OP_gmuy	Conductance of avalanche current	Ω^{-1}	none
OP_gmuz	Conductance of avalanche current	Ω^{-1}	none
OP_gmuex	Conductance of extrinsic b-c junction	Ω^{-1}	none
OP_xgmuex	Conductance of extrinsic b-c junction	Ω^{-1}	none
OP_grcvy	Conductance of epilayer current	Ω^{-1}	none
OP_grcvz	Conductance of epilayer current	Ω^{-1}	none
OP_rbv	Base resistance	Ohm	none
OP_grbvz	Early effect on base resistance	Ω^{-1}	none
OP_grbvz	Early effect on base resistance	Ω^{-1}	none
OP_re	Emitter resistance	Ohm	none
OP_rbc	Constant base resistance	Ohm	none
OP_rcc	Collector contact resistance	Ohm	none
OP_rcblx	Extrinsic buried layer resistance	Ohm	none
OP_rcbli	Intrinsic buried layer resistance	Ohm	none
OP_gs	Conductance parasitic PNP transistor	Ω^{-1}	none
OP_xgs	Conductance parasitic PNP transistor	Ω^{-1}	none
OP_gsf	Conductance substrate failure current	Ω^{-1}	none
OP_scbe	Capacitance sidewall b-e junction	F	none
OP_cbex	Capacitance floor b-e junction	F	none
OP_cbey	Early effect on b-e diffusion charge	F	none
OP_cbez	Early effect on b-e diffusion charge	F	none
OP_cbcx	Early effect on b-c diffusion charge	F	none
OP_cbcy	Capacitance floor b-c junction	F	none
OP_cbcz	Capacitance floor b-c junction	F	none
OP_cbcex	Capacitance extrinsic b-c junction	F	none
OP_xcbcex	Capacitance extrinsic b-c junction	F	none
OP_cb1b2	Capacitance AC current crowding	F	none
OP_cb1b2x	Cross-capacitance AC current crowding	F	none
OP_cb1b2y	Cross-capacitance AC current crowding	F	none
OP_cb1b2z	Cross-capacitance AC current crowding	F	none
OP_cts	Capacitance s-c junction	F	none
OP_gm	transconductance	Ω^{-1}	none
OP_beta	Current amplification		none
OP_gout	Output conductance	Ω^{-1}	none

Table 2-85. BJT level 505 Output Variables

Parameter	Description	Units	Default
OP_gmu	Feedback transconductance	Ω^{-1}	none
OP_rb	Base resistance	Ohm	none
OP_rc	Collector resistance	Ohm	none
OP_cbe	Base-emitter capacitance	C	none
OP_cbc	Base-collector capacitance	C	none
OP_ft	Good approximation for cut-off frequency		none
OP_iqs	Current at onset of quasi-saturation	A	none
OP_xiwepi	Thickness of injection layer	m	none
OP_vb2c2star	Physical value of internal base-collector bias	V	none
OP_pdiss	Dissipation	W	none
OP_tk	Actual temperature	K	none

2.3.18. Junction Field-Effect Transistor (JFET)

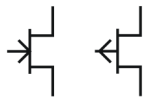
Symbol	
Instance Form	J<name> <drain node> <gate node> <source node> <model name> + [area value] [device parameters]
Examples	JIN 100 1 0 JFAST J13 22 14 23 JNOM 2.0 J1 1 2 0 2N5114
Model Form	.MODEL <model name> NJF [model parameters] .MODEL <model name> PJF [model parameters]
Parameters and Options	<p>drain node Node connected to drain.</p> <p>gate node Node connected to gate.</p> <p>source node Node connected to source.</p> <p>source node Name of model defined in .MODEL line.</p> <p>area value The JFET is modeled as an intrinsic FET using an ohmic resistance (RD/area) in series with the drain and another ohmic resistance (RS/area) in series with the source. area is an area factor with a default of 1.</p> <p>device parameters Parameters listed in Table 2-86 may be provided as space separated <parameter>=<value> specifications as needed. Any number of parameters may be specified.</p>
Comments	The JFET was first proposed and analyzed by Shockley. The SPICE-compatible JFET model is an approximation to the Shockley analysis that employs an adjustable parameter B. Both the Shockley formulation and the SPICE approximation are available in Xyce.

Device Parameters

Table 2-86. JFET Device Instance Parameters

Parameter	Description	Units	Default
AREA	Device area	m ²	1
DTEMP	Device delta temperature	°C	0
TEMP	Device temperature	–	Ambient Temperature

Model Parameters

Table 2-87. JFET Device Model Parameters

Parameter	Description	Units	Default
AF	Flicker noise exponent	–	1
B	Doping tail parameter (level 1)	V ⁻¹	1
BETA	Transconductance parameter	A/V ²	0.0001
CGD	Zero-bias gate-drain junction capacitance	F	0
CGS	Zero-bias gate-source junction capacitance	F	0
DELTA	Saturation voltage parameter (level 2)	V	0
FC	Coefficient for forward-bias depletion capacitance	F	0.5
IS	Gate junction saturation current	A	1e-14
KF	Flicker noise coefficient	–	0.05
LAMBDA	Channel length modulation	V ⁻¹	0
PB	Gate junction potential	V	1
RD	Drain ohmic resistance	Ω	0
RS	Source ohmic resistance	Ω	0
TEMPMODEL	Specifies the type of parameter interpolation over temperature	–	'NONE'
THETA	Mobility modulation parameter (level 2)	V ⁻¹	0
TNOM	Nominal device temperature	°C	Ambient Temperature
VTO	Threshold voltage	V	-2

Device Parameters

Table 2-88. JFET Device Instance Parameters

Parameter	Description	Units	Default
AREA	Device area	m ²	1
DTEMP	Device delta temperature	°C	0
TEMP	Device temperature	–	Ambient Temperature

Model Parameters

Table 2-89. JFET Device Model Parameters

Parameter	Description	Units	Default
AF	Flicker noise exponent	–	1
B	Doping tail parameter (level 1)	V ⁻¹	1
BETA	Transconductance parameter	A/V ²	0.0001
CGD	Zero-bias gate-drain junction capacitance	F	0
CGS	Zero-bias gate-source junction capacitance	F	0
DELTA	Saturation voltage parameter (level 2)	V	0
FC	Coefficient for forward-bias depletion capacitance	F	0.5
IS	Gate junction saturation current	A	1e-14
KF	Flicker noise coefficient	–	0.05
LAMBDA	Channel length modulation	V ⁻¹	0
PB	Gate junction potential	V	1
RD	Drain ohmic resistance	Ω	0
RS	Source ohmic resistance	Ω	0
TEMPMODEL	Specifies the type of parameter interpolation over temperature	–	'NONE'
THETA	Mobility modulation parameter (level 2)	V ⁻¹	0
TNOM	Nominal device temperature	°C	Ambient Temperature
VTO	Threshold voltage	V	-2

JFET Level selection Xyce supports two JFET models. LEVEL=1, the default, is the SPICE 3f5 treatment. This model employs a doping profile parameter B. When B=1, the original SPICE square law is exactly implemented, and when B=0.6 the model is close to that of Shockley.

When LEVEL=2 is selected, the Shockley model is used with some additional physics effects: channel length modulation and the effect of gate electric field on mobility. An additional parameter, DELTA, is added to the LEVEL 2 model that allows the user to adjust the saturation voltage.

JFET Power Calculations Power dissipated in the transistor is calculated with $I_D * V_{DS} + I_G * V_{GS}$ where I_D is the drain current, I_G is the gate current, V_{DS} is the voltage drop between the drain and the source and V_{GS} is the voltage drop between the gate and the source. This formula may differ from other simulators, such as HSPICE and PSpice.

2.3.19. Metal-Semiconductor FET (MESFET)

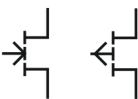
Symbol	
Instance Form	Z<name> < drain node> <gate node> <source node> <model name> + [area value] [device parameters]
Model Form	.MODEL <model name> NMF [model parameters] .MODEL <model name> PMF [model parameters]
Examples	Z1 2 3 0 MESMOD AREA=1.4 Z1 7 2 3 ZM1
Parameters and Options	<p>drain node Node connected to drain.</p> <p>gate node Node connected to gate.</p> <p>source node Node connected to source.</p> <p>source node Name of model defined in .MODEL line.</p> <p>area value The MESFET is modeled as an intrinsic FET using an ohmic resistance (RD/area) in series with the drain and another ohmic resistance (RS/area) in series with the source. area value is a scaling factor with a default of 1.</p> <p>device parameters Parameters listed in Table 2-90 may be provided as space separated <parameter>=<value> specifications as needed. Any number of parameters may be specified.</p>
Comments	Although MESFETs can be made of Si, such devices are not as common as GaAs MESFETs. And since the mobility of electrons is much higher than holes in GaAs, nearly all commercial devices are n-type MESFETs.

Device Parameters

Table 2-90. MESFET Device Instance Parameters

Parameter	Description	Units	Default
AREA	device area	m ²	1
DTEMP	Device delta temperature	°C	0
TEMP	Device temperature	–	Ambient Temperature

Model Parameters

Table 2-91. MESFET Device Model Parameters

Parameter	Description	Units	Default
AF	Flicker noise exponent	–	1
ALPHA	Saturation voltage parameter	V ⁻¹	2
B	Doping tail parameter	V ⁻¹	0.3
BETA	Transconductance parameter	A/V ²	0.0025
CGD	Zero-bias gate-drain junction capacitance	F	0
CGS	Zero-bias gate-source junction capacitance	F	0
FC	Coefficient for forward-bias depletion capacitance	F	0.5
IS	Gate junction saturation current	A	1e-14
KF	Flicker noise coefficient	–	0.05
LAMBDA	Channel length modulation	V ⁻¹	0
PB	Gate junction potential	V	1
RD	Drain ohmic resistance	Ω	0
RS	Source ohmic resistance	Ω	0
TEMPMODEL	Specifies the type of parameter interpolation over temperature	–	'NONE'
TNOM	Nominal device temperature	°C	Ambient Temperature
VTO	Threshold voltage	V	0

MESFET Power Calculations Power dissipated in the transistor is calculated with $I_D * V_{DS} + I_G * V_{GS}$ where I_D is the drain current, I_G is the gate current, V_{DS} is the voltage drop between the drain and the source and V_{GS} is the voltage drop between the gate and the source. This formula may differ from other simulators, such as HSPICE and PSpice.

2.3.20. MOS Field Effect Transistor (MOSFET)

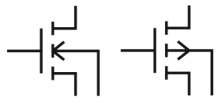
Symbol	
<hr/>	
Instance Form	<pre>M<name> <drain node> <gate node> <source node> + <bulk/substrate node> <model name> + [L=<value>] [W=<value>] + [AD=<value>] [AS=<value>] + [PD=<value>] [PS=<value>] + [NRD=<value>] [NRS=<value>] + [M=<value>] [IC=<value, ...>]</pre>
<hr/>	
Special Form (BSIMSOI)	<pre>M<name> <drain node> <gate node> <source node> + <substrate node (E)> + [<External body contact (P)>] + [<internal body contact (B)>] + [<temperature node (T)>] + <model name> + [L=<value>] [W=<value>] + [AD=<value>] [AS=<value>] + [PD=<value>] [PS=<value>] + [NRD=<value>] [NRS=<value>] [NRB=<value>] + [BJTOFF=<value>] + [IC=<val>, <val>, <val>, <val>, <val>] + [RTH0=<val>] [CTH0=<val>] + [NBC=<val>] [NSEG=<val>] [PDBCP=<val>] [PSBCP=<val>] + [AGBCP=<val>] [AEBCP=<val>] [VBSUSR=<val>] [TNODEOUT] + [FRBODY=<val>] [M=<value>]</pre>
<hr/>	
Special Form (MVS)	<pre>M<name> <drain node> <gate node> <source node> <model name></pre>
Special Form (PSP103 with self-heating)	<pre>M<name> <drain node> <gate node> <source node> <bulk node> <dt node> <model name></pre>
Model Form	<pre>.MODEL <model name> NMOS [model parameters] .MODEL <model name> PMOS [model parameters]</pre>
<hr/>	
Examples	<pre>M5 4 12 3 0 PNOM L=20u W=10u M3 5 13 10 0 PSTRONG M6 7 13 10 0 PSTRONG M=2 M8 10 12 100 100 NWEAK L=30u W=20u + AD=288p AS=288p PD=60u PS=60u NRD=14 NRS=24</pre>

Parameters and Options

L

M The MOSFET channel length and width that are decreased to get the actual channel length and width. They may be given in the device .MODEL or .OPTIONS statements. The value in the device statement overrides the value in the model statement, which overrides the value in the .OPTIONS statement. If L or W values are not given, their default value is 100 μm .

AD

AS The drain and source diffusion areas. Defaults for AD and AS can be set in the .OPTIONS statement. If AD or AS defaults are not set, their default value is 0.

PD

PS The drain and source diffusion perimeters. Their default value is 0.

NRD

NRS Multipliers (in units of \square) that can be multiplied by RSH to yield the parasitic (ohmic) resistances of the drain (RD) and source (RS), respectively. NRD, NRS default to 0.

Consider a square sheet of resistive material. Analysis shows that the resistance between two parallel edges of such a sheet depends upon its composition and thickness, but is independent of its size as long as it is square. In other words, the resistance will be the same whether the square's edge is 2 mm, 2 cm, or 2 m. For this reason, the *sheet resistance* of such a layer, abbreviated RSH, has units of Ohms per square, written Ω/\square .

M If specified, the value is used as a number of parallel MOSFETs to be simulated. For example, if M=2 is specified, Xyce simulates two identical mosfets connected to the same nodes in parallel.

IC The BSIM3 (model level 9), BSIM4 (model level 14 or 54) and BSIMSOI (model level 10) allow one to specify the initial voltage difference across nodes of the device during the DC operating point calculation. For the BSIM3 and BSIM4 the syntax is IC= V_{ds}, V_{gs}, V_{bs} where V_{ds} is the voltage difference between the drain and source, V_{gs} is the voltage difference between the gate and source and V_{bs} is the voltage difference between the body and source. The BSIMSOI device's initial condition syntax is IC= $V_{ds}, V_{gs}, V_{bs}, V_{es}, V_{ps}$ where the two extra terms are the voltage difference between the substrate and source, and the external body and source nodes respectively. Note that for any of these lists of voltage differences, fewer than the full number of options may be specified. For example, IC=5.0 specifies an initial condition on V_{ds} but does not specify any initial conditions on the other nodes. Therefore, one cannot specify V_{gs} without specifying V_{ds} , etc.

It is illegal to specify initial conditions on any nodes that are tied together. Xyce attempts to catch such errors, but complex circuits may stymie this error trap.

BSIM-SOI Options

There are a large number of extra instance parameters and optional nodes available for the BSIM-SOI (level 10 (BSIM-SOI 3.2), level 70 (BSIM-SOI 4.6.1), and level 70450 (BSIM-SOI 4.5.0)) MOSFET. Please consult the BSIM-SOI technical manual, available at <http://bsim.berkeley.edu/models/bsimsoi/>, for full details.

substrate node

The fourth node of the BSIM-SOI device is always the substrate node, which is referred to as the E node.

external body contact node

If given, the fifth node is the external body contact node, P. It is connected to the internal body node through a body tie resistor. If P is not given, the internal body node is not accessible from the netlist and floats.

For the BSIM-SOI 3.2 (level=10) only: If there are only five nodes specified and TNODEOUT is also specified, the fifth node is the temperature node instead.

internal body contact node

If given, the sixth node is the internal body contact node, B. It is connected to the external body node through a body tie resistor. If B is not given and P is given, the internal body node is not accessible from the netlist, but is still tied to the external body contact through the tie resistance.

For the BSIM-SOI 3.2 (level=10) only: If there are only six nodes specified and TNODEOUT is also specified, the sixth node is the temperature node instead.

temperature node

For the BSIM-SOI 3.2 (level=10) only: If the parameter TNODEOUT is specified, the final node (fifth, sixth, or seventh) is interpreted as a temperature node. The temperature node is intended for thermal coupling simulation.

For the BSIM-SOI 4.x (level=70 or 70450) only: The temperature node is only accessible for thermal coupling if it is the seventh node. It is available for printing as an internal node in all other configurations.

BJTOFF

Turns off the parasitic BJT currents.

IC The IC parameter allows specification of the five junction initial conditions, V_{ds} , V_{gs} , V_{bs} , V_{es} and V_{ps} . V_{ps} is ignored in a four-terminal device.

RTH0

Thermal resistance per unit width. Taken from model card if not given.

CTH0

Thermal capacitance per unit width. Taken from model card if not given.

NBC Number of body contact isolation edges.

NSEG

Number of segments for channel width partitioning.

PDBCP

Parasitic perimeter length for body contact at drain side.

PSBCP

Parasitic perimeter length for body contact at source side.

AGBCP

Parasitic gate-to-body overlap area for body contact.

AEBCP

Parasitic body-to-substrate overlap area for body contact.

VBSUSR

Optional initial value of VBS specified by user for use in transient analysis.
(unused in Xyce).

FRBODY

Layout-dependent body resistance coefficient.

Comments

The simulator provides multiple MOSFET device models, which differ in the formulation of the I-V characteristic. The LEVEL parameter selects among different models as shown below.

For HSPICE compatibility, the BSIM4 model can be specified with either level 14 or level 54.

If a model supports parameter aliases (e.g. “U0” and “UO” or “VT0” and “VTO” in the levels 1-6 MOSFETS), it would be a mistake to specify both parameters and give them different values. There is no warning or error message if you do that. Don't do that.

MOSFET Operating Temperature Model parameters may be assigned unique measurement temperatures using the TNOM model parameter. See the MOSFET model parameters for more information.

MOSFET Power Calculations Power dissipated in the transistor is calculated with $I_D * V_{DS} + I_G * V_{GS}$ where I_D is the drain current, I_G is the gate current, V_{DS} is the voltage drop between the drain and the source and V_{GS} is the voltage drop between the gate and the source. This formula may differ from other simulators, such as HSPICE and PSpice.

Internal Device Variables Accessible with N() Syntax For the BSIM3, BSIM4, and BSIM-CMG version 110 models, several internal variables have been made accessible with the N() syntax on a .PRINT line. They are g_m (transconductance), V_{th} , V_{ds} , V_{gs} , V_{bs} , and V_{dsat} . An example .PRINT line command for a MOSFET device named m1 would be:

```
.print dc N(m1:gm) N(m1:Vth) N(m1:Vdsat) N(m1:Vds) N(m1:Vgs) N(m1:Vbs)
```

The BSIM-CMG also supports output of I_{ds} (drain-source current) in this manner.

If the user runs `Xyce -namesfile <filename> <netlist>` then Xyce will output into the first filename a list of all solution variables generated by that netlist. This can be useful for determining the “fully-qualified” device name, needed for the `N()` syntax, if the device is in a subcircuit.

Instance Parameters Tables 2-92, 2-94, 2-96, 2-98, 2-100 and 2-102 give the available instance parameters for the levels 1,2,3,6,9 and 10 MOSFETs, respectively.

In addition to the parameters shown in the tables, where a list of numbered initial condition parameters are shown, the MOSFETs support a vector parameter for the initial conditions. IC1 and IC2 may therefore be specified compactly as `IC=<ic1>,<ic2>`.

Model Parameters Tables 2-93, 2-95, 2-97, 2-99, 2-101, and 2-103 give the available model parameters for the levels 1,2,3,6,9 and 10 MOSFETs, respectively.

For a thorough description of MOSFET models see [17, 18, 19, 20, 21, 22, 23, 24, 25, 26].

All MOSFET models The parameters shared by all MOSFET model levels are principally parasitic element values (e.g., series resistance, overlap capacitance, etc.).

Model levels 1 and 3 The DC behaviors of the level 1 and 3 MOSFET models are defined by the parameters **VTO**, **KP**, **LAMBDA**, **PHI**, and **GAMMA**. The simulator calculates these if the process parameters (e.g., **TOX**, and **NSUB**) are specified, but these are always overridden by any user-defined values. The **VTO** value is positive (negative) for modeling the enhancement mode and negative (positive) for the depletion mode of N-channel (P-channel) devices.

For MOSFETs, the capacitance model enforces charge conservation, influencing just the Level 1 and 3 models.

Effective device parameter lengths and widths are calculated as follows:

$$P_i = P_0 + P_L/L_e + P_W/W_e$$

where

$$\begin{aligned} L_e &= \text{effective length} = \mathbf{L} - (2 \cdot \mathbf{LD}) \\ W_e &= \text{effective width} = \mathbf{W} - (2 \cdot \mathbf{WD}) \end{aligned}$$

See **.MODEL** (model definition) for more information.

Model level 9 (BSIM3 version 3.2.2) The University of California, Berkeley BSIM3 model is a physical-based model with a large number of dependencies on essential dimensional and processing parameters. It incorporates the key effects that are critical in modeling deep-submicrometer MOSFETs. These include threshold voltage reduction, nonuniform doping, mobility reduction due to the vertical field, bulk charge effect, carrier velocity saturation, drain-induced barrier lowering (DIBL), channel length modulation (CLM), hot-carrier-induced output resistance reduction, subthreshold conduction, source/drain parasitic resistance, substrate current induced body effect (SCBE) and drain voltage reduction in LDD structure.

The BSIM3 Version 3.2.2 model is a deep submicron MOSFET model with several major enhancements over earlier versions. These include a single I-V formula used to define the current and output conductance for operating regions, improved narrow width device modeling, a superior capacitance model with improved short and narrow geometry models, a new relaxation-time model to better transient modeling and enhanced model fitting of assorted W/L ratios using a single parameter set. This version preserves the large number of integrated dependencies on dimensional and processing parameters of the Version 2 model. For further information, see Reference [18].

Additional notes

1. If any of the following BSIM3 3.2.2 model parameters are not specified, they are computed via the following:

If **VTHO** is not specified, then:

$$\mathbf{VTHO} = \mathbf{VFB} + \phi_s \mathbf{K1} \sqrt{\phi_s}$$

where:

$$\mathbf{VFB} = -1.0$$

If **VTHO** is given, then:

$$\begin{aligned} \mathbf{VFB} &= \mathbf{VTHO} - \phi_s + \mathbf{K1} \sqrt{p h i_s} \\ \mathbf{VBX} &= \phi_s - \frac{q \cdot \mathbf{NCH} \cdot \mathbf{XT}^2}{2 \varepsilon_{si}} \\ \mathbf{CF} &= \left(\frac{2 \varepsilon_{ox}}{\pi} \right) \ln \left(1 + \frac{1}{4 \times 10^7 \cdot \mathbf{TOX}} \right) \end{aligned}$$

where:

$$E_g(T) = \text{the energy bandgap at temperature } T = 1.16 - \frac{T^2}{7.02 \times 10^4 (T + 1108)}$$

2. If **K1** and **K2** are not given then they are computed via the following:

$$\begin{aligned} \mathbf{K1} &= \mathbf{GAMMA2} - 2 \cdot \mathbf{K2} \sqrt{\phi_s - \mathbf{VBM}} \\ \mathbf{K2} &= \frac{(\mathbf{GAMMA1} - \mathbf{GAMMA2})(\sqrt{\phi_s - \mathbf{VBX}} - \sqrt{\phi_s})}{2\sqrt{\phi_s}(\sqrt{\phi_s - \mathbf{VBM}} - \sqrt{\phi_s}) + \mathbf{VBM}} \end{aligned}$$

where:

$$\begin{aligned}\phi_s &= 2V_t \ln\left(\frac{\mathbf{NCH}}{n_i}\right) \\ V_t &= kT/q \\ n_i &= 1.45 \times 10^{10} \left(\frac{T}{300.15}\right)^{1.5} \exp\left(21.5565981 - \frac{E_g(T)}{2V_t}\right)\end{aligned}$$

3. If **NCH** is not specified and **GAMMA1** is, then:

$$\mathbf{NCH} = \frac{\mathbf{GAMMA1}^2 \times \mathbf{COX}^2}{2q\epsilon_{si}}$$

If **GAMMA1** and **NCH** are not specified, then **NCH** defaults to $1.7 \times 10^{23} \text{ m}^{-3}$ and **GAMMA1** is computed using **NCH**:

$$\mathbf{GAMMA1} = \frac{\sqrt{2q\epsilon_{si} \cdot \mathbf{NCH}}}{\mathbf{COX}}$$

If **GAMMA2** is not specified, then:

$$\mathbf{GAMMA2} = \frac{\sqrt{2q\epsilon_{si} \cdot \mathbf{NSUB}}}{\mathbf{COX}}$$

4. If **CGSO** is not specified and **DLC** > 0, then:

$$\mathbf{CGSO} = \begin{cases} 0, & ((\mathbf{DLC} \cdot \mathbf{COX}) - \mathbf{CGSL}) < 0 \\ 0.6 \cdot \mathbf{XJ} \cdot \mathbf{COX}, & ((\mathbf{DLC} \cdot \mathbf{COX}) - \mathbf{CGSL}) \geq 0 \end{cases}$$

5. If **CGDO** is not specified and **DLC** > 0, then:

$$\mathbf{CGDO} = \begin{cases} 0, & ((\mathbf{DLC} \cdot \mathbf{COX}) - \mathbf{CGSL}) < 0 \\ 0.6 \cdot \mathbf{XJ} \cdot \mathbf{COX}, & ((\mathbf{DLC} \cdot \mathbf{COX}) - \mathbf{CGSL}) \geq 0 \end{cases}$$

Model level 10 (BSIM-SOI version 3.2) The BSIM-SOI is an international standard model for SOI (silicon on insulator) circuit design and is formulated on top of the BSIM3v3 framework. A detailed description can be found in the BSIM-SOI 3.1 User's Manual [27] and the BSIM-SOI 3.2 release notes [28].

This version (v3.2) of the BSIM-SOI includes three depletion models; the partially depleted BSIM-SOI PD (soiMod=0), the fully depleted BSIM-SOI FD (soiMod=2), and the unified SOI model (soiMod=1).

BSIMPD is the Partial-Depletion (PD) mode of the BSIM-SOI. A typical PD SOI MOSFET is formed on a thin SOI film which is layered on top of a buried oxide. BSIMPD has the following features and enhancements:

- Real floating body simulation of both I-V and C-V. The body potential is determined by the balance of all body current components.
- An improved parasitic bipolar current model. This includes enhancements in the various diode leakage components, second order effects (high-level injection and Early effect), diffusion charge equation, and temperature dependence of the diode junction capacitance.

- An improved impact-ionization current model. The contribution from BJT current is also modeled by the parameter F_{bjt} .
- A gate-to-body tunneling current model, which is important to thin-oxide SOI technologies.
- Enhancements in the threshold voltage and bulk charge formulation of the high positive body bias regime.
- Instance parameters (P_{dbc} , P_{sbc} , A_{gbc} , A_{ebc} , N_{bc}) are provided to model the parasitics of devices with various body-contact and isolation structures.
- An external body node (the 6th node) and other improvements are introduced to facilitate the modeling of distributed body resistance.
- Self heating. An external temperature node (the 7th node) is supported to facilitate the simulation of thermal coupling among neighboring devices.
- A unique SOI low frequency noise model, including a new excess noise resulting from the floating body effect.
- Width dependence of the body effect is modeled by parameters (K_1, K_1w_1, K_1w_2).
- Improved history dependence of the body charges with two new parameters (F_{body} , $DLCB$).
- An instance parameter V_{bsur} is provided for users to set the transient initial condition of the body potential.
- The new charge-thickness capacitance model introduced in BSIM3v3.2, $capMod=3$, is included.

Quadratic Temperature Compensation SPICE temperature effects are the default, but MOSFET levels 18, 19 and 20 have a more advanced temperature compensation available. By specifying $TEMPMODEL=QUADRATIC$ in the netlist, parameters can be interpolated quadratically between measured values extracted from data. See Section ?? for more details.

MOSFET Equations The following equations define an N-channel MOSFET. The P-channel devices use a reverse the sign for all voltages and currents. The equations use the following variables:

- V_{bs} = intrinsic substrate-intrinsic source voltage
- V_{bd} = intrinsic substrate-intrinsic drain voltage
- V_{ds} = intrinsic drain-substrate source voltage
- V_{dsat} = saturation voltage
- V_{gs} = intrinsic gate-intrinsic source voltage
- V_{gd} = intrinsic gate-intrinsic drain voltage
- V_t = kT/q (thermal voltage)
- V_{th} = threshold voltage
- C_{ox} = the gate oxide capacitance per unit area
- f = noise frequency
- k = Boltzmann's constant
- q = electron charge
- L_{eff} = effective channel length
- W_{eff} = effective channel width
- T = analysis temperature (K)
- T_0 = nominal temperature (set using TNOM option)

Other variables are listed in the BJT Equations section 2.3.17.1.

All Levels

$$I_g = \text{gate current} = 0$$

$$I_b = \text{bulk current} = I_{bs} + I_{bd}$$

where

$$I_{bs} = \text{bulk-source leakage current} = I_{ss} \left(e^{V_{bs}/(NV_t)} - 1 \right)$$

$$I_{ds} = \text{bulk-drain leakage current} = I_{ds} \left(e^{V_{bd}/(NV_t)} - 1 \right)$$

where

if

$$\mathbf{JS} = 0, \text{ or } \mathbf{AS} = 0 \text{ or } \mathbf{AD} = 0$$

then

$$I_{ss} = \mathbf{IS}$$

$$I_{ds} = \mathbf{IS}$$

else

$$I_{ss} = \mathbf{AS} \times \mathbf{JS} + \mathbf{PS} \times \mathbf{JSSW}$$

$$I_{ds} = \mathbf{AD} \times \mathbf{JS} + \mathbf{PD} \times \mathbf{JSSW}$$

$$I_d = \text{drain current} = I_{drain} - I_{bd}$$

$$I_s = \text{source current} = -I_{drain} - I_{bs}$$

Level 1: I_{drain}

Normal Mode: $V_{ds} > 0$

Case 1

For cutoff region: $V_{gs} - V_{to} < 0$

$$I_{drain} = 0$$

Case 2

For linear region: $V_{ds} < V_{gs} - V_{to}$

$$I_{drain} = (W/L)(KN/2)(1 + LAMBDA \times V_{ds})V_{ds}(2(V_{gs} - V_{to}) - V_{ds})$$

Case 3

For saturation region: $0 \leq V_{gs} - V_{to} \leq V_{ds}$

$$I_{drain} = (W/L)(KN/2)(1 + LAMBDA \cdot V_{ds})(V_{gs} - V_{to})^2$$

where

$$V_{to} = VTO + GAMMA \cdot \left((PHI - V_{bs})^{1/2} \right)^{1/2}$$

Inverted Mode: $V_{ds} < 0$

Here, simply switch the source and drain in the normal mode equations given above.

Level 3: Idrain

See Reference [21] below for detailed information.

Capacitance

Level 1 ,2, and 3

C_{bs} = bulk-source capacitance = area cap. + sidewall cap. + transit time cap.

C_{bd} = bulk-drain capacitance = area cap. + sidewall cap. + transit time cap.

where

if

$$\mathbf{CBS} = 0 \text{ and } \mathbf{CBD} = 0$$

then

$$C_{bs} = \mathbf{AS} \cdot \mathbf{CJ} \cdot C_{bsj} + \mathbf{PS} \cdot \mathbf{CJSW} \cdot C_{bss} + \mathbf{TT} \cdot G_{bs}$$

$$C_{bd} = \mathbf{AD} \cdot \mathbf{CJ} \cdot C_{bdj} + \mathbf{PD} \cdot \mathbf{CJSW} \cdot C_{bds} + \mathbf{TT} \cdot G_{ds}$$

else

$$C_{bs} = \mathbf{CBS} \cdot C_{bsj} + \mathbf{PS} \cdot \mathbf{CJSW} \cdot C_{bss} + \mathbf{TT} \cdot G_{bs}$$

$$C_{bd} = \mathbf{CBD} \cdot C_{bdj} + \mathbf{PD} \cdot \mathbf{CJSW} \cdot C_{bds} + \mathbf{TT} \cdot G_{ds}$$

where

$$G_{bs} = \text{DC bulk-source conductance} = dI_{bs}/dV_{bs}$$

$$G_{bd} = \text{DC bulk-drain conductance} = dI_{bd}/dV_{bd}$$

if

$$V_{bs} \leq \mathbf{FC} \cdot \mathbf{PB}$$

then

$$C_{bsj} = (1 - V_{bs}/\mathbf{PB})^{-\mathbf{MJ}}$$

$$C_{bss} = (1 - V_{bs}/\mathbf{PBSW})^{-\mathbf{MJSW}}$$

if

$$V_{bs} > \mathbf{FC} \cdot \mathbf{PB}$$

then

$$C_{bsj} = (1 - \mathbf{FC})^{-(1+\mathbf{MJ})} (1 - \mathbf{FC}(1 + \mathbf{MJ}) + \mathbf{MJ} \cdot V_{bs}/\mathbf{PB})$$

$$C_{bss} = (1 - \mathbf{FC})^{-(1+\mathbf{MJSW})} (1 - \mathbf{FC}(1 + \mathbf{MJSW}) + \mathbf{MJSW} \cdot V_{bs}/\mathbf{PBSW})$$

if

$$V_{bd} \leq \mathbf{FC} \cdot \mathbf{PB}$$

then

$$C_{bdj} = (1 - V_{bd}/\mathbf{PB})^{-\mathbf{MJ}}$$

$$C_{bds} = (1 - V_{bd}/\mathbf{PBSW})^{-\mathbf{MJSW}}$$

if

$$V_{bd} > \mathbf{FC} \cdot \mathbf{PB}$$

then

$$C_{bdj} = (1 - \mathbf{FC})^{-(1+\mathbf{MJ})} (1 - \mathbf{FC}(1 + \mathbf{MJ}) + \mathbf{MJ} \cdot V_{bd}/\mathbf{PB})$$

$$C_{bds} = (1 - \mathbf{FC})^{-(1+\mathbf{MJSW})} (1 - \mathbf{FC}(1 + \mathbf{MJSW}))$$

$$C_{gs} = \text{gate-source overlap capacitance} = \mathbf{CGSO} \cdot \mathbf{W}$$

$$C_{gd} = \text{gate-drain overlap capacitance} = \mathbf{CGDO} \cdot \mathbf{W}$$

$$C_{gb} = \text{gate-bulk overlap capacitance} = \mathbf{CGBO} \cdot \mathbf{L}$$

Temperature Effects

All Levels

$$\mathbf{IS}(T) = \mathbf{IS} \cdot \exp(E_g(T_0) \cdot T/T_0 - E_g(T)) / V_t$$

$$\mathbf{JS}(T) = \mathbf{JS} \cdot \exp(E_g(T_0) \cdot T/T_0 - E_g(T)) / V_t$$

$$\mathbf{JSSW}(T) = \mathbf{JSSW} \cdot \exp(E_g(T_0) \cdot T/T_0 - E_g(T)) / V_t$$

$$\mathbf{PB}(T) = \mathbf{PB} \cdot T/T_0 - 3V_t \ln(T/T_0) - E_g(T_0) \cdot T/T_0 + E_g T$$

$$\mathbf{PBSW}(T) = \mathbf{PBSW} \cdot T/T_0 - 3V_t \ln(T/T_0) - E_g(T_0) \cdot T/T_0 + E_g T$$

$$\mathbf{PHI}(T) = \mathbf{PHI} \cdot T/T_0 - 3V_t \ln(T/T_0) - E_g(T_0) \cdot T/T_0 + E_g T$$

where

$$E_g(T) = \text{silicon bandgap energy} = 1.16 - 0.000702T^2/(T + 1108)$$

$$\mathbf{CBD}(T) = \mathbf{CBD} \cdot (1 + \mathbf{MJ} \cdot (0.0004(T - T_0) + (1 - \mathbf{PB}(T)/\mathbf{PB})))$$

$$\mathbf{CBS}(T) = \mathbf{CBS} \cdot (1 + \mathbf{MJ} \cdot (0.0004(T - T_0) + (1 - \mathbf{PB}(T)/\mathbf{PB})))$$

$$\mathbf{CJ}(T) = \mathbf{CJ} \cdot (1 + \mathbf{MJ} \cdot (0.0004(T - T_0) + (1 - \mathbf{PB}(T)/\mathbf{PB})))$$

$$\mathbf{CJSW}(T) = \mathbf{CJSW} \cdot (1 + \mathbf{MJSW} \cdot (0.0004(T - T_0) + (1 - \mathbf{PB}(T)/\mathbf{PB})))$$

$$\mathbf{KP}(T) = \mathbf{KP} \cdot (T/T_0)^{-3/2}$$

$$\mathbf{UO}(T) = \mathbf{UO} \cdot (T/T_0)^{-3/2}$$

$$\mathbf{MUS}(T) = \mathbf{MUS} \cdot (T/T_0)^{-3/2}$$

$$\mathbf{MUZ}(T) = \mathbf{MUZ} \cdot (T/T_0)^{-3/2}$$

$$\mathbf{X3MS}(T) = \mathbf{X3MS} \cdot (T/T_0)^{-3/2}$$

2.3.20.1. Level 1 MOSFET Tables (SPICE Level 1)

Table 2-92. MOSFET level 1 Device Instance Parameters

Parameter	Description	Units	Default
AD	Drain diffusion area	m ²	0
AS	Source diffusion area	m ²	0
DTEMP	Device delta temperature	°C	0
IC1	Initial condition on Drain-Source voltage	V	0
IC2	Initial condition on Gate-Source voltage	V	0
IC3	Initial condition on Bulk-Source voltage	V	0
L	Channel length	m	0
M	Multiplier for M devices connected in parallel	–	1
NRD	Multiplier for RSH to yield parasitic resistance of drain	<input type="checkbox"/>	1
NRS	Multiplier for RSH to yield parasitic resistance of source	<input type="checkbox"/>	1
OFF	Initial condition of no voltage drops across device	logical (T/F)	false
PD	Drain diffusion perimeter	m	0
PS	Source diffusion perimeter	m	0
TEMP	Device temperature	°C	Ambient Temperature
W	Channel width	m	0

Table 2-93. MOSFET level 1 Device Model Parameters

Parameter	Description	Units	Default
AF	Flicker noise exponent	–	1
CBD	Zero-bias bulk-drain p-n capacitance	F	0
CBS	Zero-bias bulk-source p-n capacitance	F	0
CGBO	Gate-bulk overlap capacitance/channel length	F/m	0
CGDO	Gate-drain overlap capacitance/channel width	F/m	0
CGSO	Gate-source overlap capacitance/channel width	F/m	0
CJ	Bulk p-n zero-bias bottom capacitance/area	F/m ²	0
CJSW	Bulk p-n zero-bias sidewall capacitance/area	F/m ²	0
FC	Bulk p-n forward-bias capacitance coefficient	–	0.5
GAMMA	Bulk threshold parameter	V ^{1/2}	0
IS	Bulk p-n saturation current	A	1e-14
JS	Bulk p-n saturation current density	A/m ²	0

Table 2-93. MOSFET level 1 Device Model Parameters

Parameter	Description	Units	Default
KF	Flicker noise coefficient	–	0
KP	Transconductance coefficient	A/V ²	2e-05
L	Default channel length	m	0.0001
LAMBDA	Channel-length modulation	V ⁻¹	0
LD	Lateral diffusion length	m	0
MJ	Bulk p-n bottom grading coefficient	–	0.5
MJSW	Bulk p-n sidewall grading coefficient	–	0.5
NSS	Surface state density	cm ⁻²	0
NSUB	Substrate doping density	cm ⁻³	0
PB	Bulk p-n bottom potential	V	0.8
PHI	Surface potential	V	0.6
RD	Drain ohmic resistance	Ω	0
RS	Source ohmic resistance	Ω	0
RSH	Drain,source diffusion sheet resistance	Ω	0
TEMPMODEL	Specifies the type of parameter interpolation over temperature	–	'NONE'
TNOM	Nominal device temperature	°C	27
TOX	Gate oxide thickness	m	1e-07
TPG	Gate material type (-1 = same as substrate) 0 = aluminum, 1 = opposite of substrate)	–	0
U0	Surface mobility (alias for UO)	1/(Vcm ² s)	600
UO	Surface mobility	1/(Vcm ² s)	600
VT0	Zero-bias threshold voltage (alias for VTO)	V	0
VTO	Zero-bias threshold voltage	V	0
W	Default channel width	m	0.0001

2.3.20.2. Level 2 MOSFET Tables (SPICE Level 2)

Table 2-94. MOSFET level 2 Device Instance Parameters

Parameter	Description	Units	Default
AD	Drain diffusion area	m ²	0
AS	Source diffusion area	m ²	0
DTEMP	Device delta temperature	°C	0
IC1	Initial condition on Drain-Source voltage	V	0
IC2	Initial condition on Gate-Source voltage	V	0
IC3	Initial condition on Bulk-Source voltage	V	0
L	Channel length	m	0
M	Multiplier for M devices connected in parallel	–	1
NRD	Multiplier for RSH to yield parasitic resistance of drain	<input type="checkbox"/>	1
NRS	Multiplier for RSH to yield parasitic resistance of source	<input type="checkbox"/>	1
OFF	Initial condition of no voltage drops across device	logical (T/F)	false
PD	Drain diffusion perimeter	m	0
PS	Source diffusion perimeter	m	0
TEMP	Device temperature	°C	Ambient Temperature
W	Channel width	m	0

Table 2-95. MOSFET level 2 Device Model Parameters

Parameter	Description	Units	Default
AF	Flicker noise exponent	–	1
CBD	Zero-bias bulk-drain p-n capacitance	F	0
CBS	Zero-bias bulk-source p-n capacitance	F	0
CGBO	Gate-bulk overlap capacitance/channel length	F/m	0
CGDO	Gate-drain overlap capacitance/channel width	F/m	0
CGSO	Gate-source overlap capacitance/channel width	F/m	0
CJ	Bulk p-n zero-bias bottom capacitance/area	F/m ²	0
CJSW	Bulk p-n zero-bias sidewall capacitance/area	F/m ²	0
DELTA	Width effect on threshold	–	0
FC	Bulk p-n forward-bias capacitance coefficient	–	0.5
GAMMA	Bulk threshold parameter	V ^{1/2}	0
IS	Bulk p-n saturation current	A	1e-14

Table 2-95. MOSFET level 2 Device Model Parameters

Parameter	Description	Units	Default
JS	Bulk p-n saturation current density	A/m ²	0
KF	Flicker noise coefficient	–	0
KP	Transconductance coefficient	A/V ²	2e-05
L	Default channel length	m	0.0001
LAMBDA	Channel-length modulation	V ⁻¹	0
LD	Lateral diffusion length	m	0
MJ	Bulk p-n bottom grading coefficient	–	0.5
MJSW	Bulk p-n sidewall grading coefficient	–	0.5
NEFF	Total channel charge coeff.	–	1
NFS	Fast surface state density	–	0
NSS	Surface state density	cm ⁻²	0
NSUB	Substrate doping density	cm ⁻³	0
PB	Bulk p-n bottom potential	V	0.8
PHI	Surface potential	V	0.6
RD	Drain ohmic resistance	Ω	0
RS	Source ohmic resistance	Ω	0
RSH	Drain,source diffusion sheet resistance	Ω	0
TEMPMODEL	Specifies the type of parameter interpolation over temperature	–	'NONE'
TNOM	Nominal device temperature	°C	27
TOX	Gate oxide thickness	m	1e-07
TPG	Gate material type (-1 = same as substrate, 0 = aluminum, 1 = opposite of substrate)	–	0
U0	Surface mobility (alias for UO)	1/(Vcm ² s)	600
UCRIT	Crit. field for mob. degradation	–	10000
UEXP	Crit. field exp for mob. deg.	–	0
UO	Surface mobility	1/(Vcm ² s)	600
VMAX	Maximum carrier drift velocity	–	0
VT0	Zero-bias threshold voltage (alias for VTO)	V	0
VTO	Zero-bias threshold voltage	V	0
W	Default channel width	m	0.0001
XJ	Junction depth	–	0

2.3.20.3. Level 3 MOSFET Tables (SPICE Level 3)

Table 2-96. MOSFET level 3 Device Instance Parameters

Parameter	Description	Units	Default
AD	Drain diffusion area	m ²	0
AS	Source diffusion area	m ²	0
DTEMP	Device delta temperature	°C	0
IC1	Initial condition on Drain-Source voltage	V	0
IC2	Initial condition on Gate-Source voltage	V	0
IC3	Initial condition on Bulk-Source voltage	V	0
L	Channel length	m	0
M	Multiplier for M devices connected in parallel	–	1
NRD	Multiplier for RSH to yield parasitic resistance of drain	<input type="checkbox"/>	1
NRS	Multiplier for RSH to yield parasitic resistance of source	<input type="checkbox"/>	1
OFF	Initial condition of no voltage drops across device	logical (T/F)	false
PD	Drain diffusion perimeter	m	0
PS	Source diffusion perimeter	m	0
TEMP	Device temperature	°C	Ambient Temperature
W	Channel width	m	0

Table 2-97. MOSFET level 3 Device Model Parameters

Parameter	Description	Units	Default
AF	Flicker noise exponent	–	1
CBD	Zero-bias bulk-drain p-n capacitance	F	0
CBS	Zero-bias bulk-source p-n capacitance	F	0
CGBO	Gate-bulk overlap capacitance/channel length	F/m	0
CGDO	Gate-drain overlap capacitance/channel width	F/m	0
CGSO	Gate-source overlap capacitance/channel width	F/m	0
CJ	Bulk p-n zero-bias bottom capacitance/area	F/m ²	0
CJSW	Bulk p-n zero-bias sidewall capacitance/area	F/m ²	0
DELTA	Width effect on threshold	–	0
ETA	Static feedback	–	0
FC	Bulk p-n forward-bias capacitance coefficient	–	0.5
GAMMA	Bulk threshold parameter	V ^{1/2}	0

Table 2-97. MOSFET level 3 Device Model Parameters

Parameter	Description	Units	Default
IS	Bulk p-n saturation current	A	1e-14
JS	Bulk p-n saturation current density	A/m ²	0
KAPPA	Saturation field factor	-	0.2
KF	Flicker noise coefficient	-	0
KP	Transconductance coefficient	A/V ²	2e-05
L	Default channel length	m	0.0001
LD	Lateral diffusion length	m	0
MJ	Bulk p-n bottom grading coefficient	-	0.5
MJSW	Bulk p-n sidewall grading coefficient	-	0.33
NFS	Fast surface state density	cm ⁻²	0
NSS	Surface state density	cm ⁻²	0
NSUB	Substrate doping density	cm ⁻³	0
PB	Bulk p-n bottom potential	V	0.8
PHI	Surface potential	V	0.6
RD	Drain ohmic resistance	Ω	0
RS	Source ohmic resistance	Ω	0
RSH	Drain,source diffusion sheet resistance	Ω	0
TEMPMODEL	Specifies the type of parameter interpolation over temperature	-	'NONE'
THETA	Mobility modulation	V ⁻¹	0
TNOM	Nominal device temperature	°C	27
TOX	Gate oxide thickness	m	1e-07
TPG	Gate material type (-1 = same as substrate,0 = aluminum,1 = opposite of substrate)	-	1
U0	Surface mobility (alias for UO)	1/(Vcm ² s)	600
UO	Surface mobility	1/(Vcm ² s)	600
VMAX	Maximum drift velocity	m/s	0
VT0	Zero-bias threshold voltage (alias for VTO)	V	0
VTO	Zero-bias threshold voltage	V	0
W	Default channel width	m	0.0001
XJ	Metallurgical junction depth	m	0

2.3.20.4. Level 6 MOSFET Tables (SPICE Level 6)

Table 2-98. MOSFET level 6 Device Instance Parameters

Parameter	Description	Units	Default
AD	Drain diffusion area	m ²	0
AS	Source diffusion area	m ²	0
DTEMP	Device delta temperature	°C	0
IC1	Initial condition on Drain-Source voltage	V	0
IC2	Initial condition on Gate-Source voltage	V	0
IC3	Initial condition on Bulk-Source voltage	V	0
L	Channel length	m	0
M	Multiplier for M devices connected in parallel	–	1
NRD	Multiplier for RSH to yield parasitic resistance of drain	<input type="checkbox"/>	1
NRS	Multiplier for RSH to yield parasitic resistance of source	<input type="checkbox"/>	1
OFF	Initial condition of no voltage drops across device	logical (T/F)	false
PD	Drain diffusion perimeter	m	0
PS	Source diffusion perimeter	m	0
TEMP	Device temperature	°C	Ambient Temperature
W	Channel width	m	0

Table 2-99. MOSFET level 6 Device Model Parameters

Parameter	Description	Units	Default
AF	Flicker noise exponent	–	1
CBD	Zero-bias bulk-drain p-n capacitance	F	0
CBS	Zero-bias bulk-source p-n capacitance	F	0
CGBO	Gate-bulk overlap capacitance/channel length	F/m	0
CGDO	Gate-drain overlap capacitance/channel width	F/m	0
CGSO	Gate-source overlap capacitance/channel width	F/m	0
CJ	Bulk p-n zero-bias bottom capacitance/area	F/m ²	0
CJSW	Bulk p-n zero-bias sidewall capacitance/area	F/m ²	0
FC	Bulk p-n forward-bias capacitance coefficient	–	0.5
GAMMA	Bulk threshold parameter	–	0
GAMMA1	Bulk threshold parameter 1	–	0
IS	Bulk p-n saturation current	A	1e-14

Table 2-99. MOSFET level 6 Device Model Parameters

Parameter	Description	Units	Default
JS	Bulk p-n saturation current density	A/m ²	0
KC	Saturation current factor	–	5e-05
KF	Flicker noise coefficient	–	0
KV	Saturation voltage factor	–	2
LAMBDA	Channel length modulation param.	–	0
LAMBDA0	Channel length modulation param. 0	–	0
LAMBDA1	Channel length modulation param. 1	–	0
LD	Lateral diffusion length	m	0
MJ	Bulk p-n bottom grading coefficient	–	0.5
MJSW	Bulk p-n sidewall grading coefficient	–	0.5
NC	Saturation current coeff.	–	1
NSS	Surface state density	cm ⁻²	0
NSUB	Substrate doping density	cm ⁻³	0
NV	Saturation voltage coeff.	–	0.5
NVTH	Threshold voltage coeff.	–	0.5
PB	Bulk p-n bottom potential	V	0.8
PHI	Surface potential	V	0.6
PS	Sat. current modification par.	–	0
RD	Drain ohmic resistance	Ω	0
RS	Source ohmic resistance	Ω	0
RSH	Drain,source diffusion sheet resistance	Ω	0
SIGMA	Static feedback effect par.	–	0
TEMPMODEL	Specifies the type of parameter interpolation over temperature	–	'NONE'
TNOM	Nominal device temperature	°C	27
TOX	Gate oxide thickness	m	1e-07
TPG	Gate material type (-1 = same as substrate,0 = aluminum,1 = opposite of substrate)	–	1
U0	Surface mobility (alias for UO)	1/(Vcm ² s)	600
UO	Surface mobility	1/(Vcm ² s)	600
VT0	Zero-bias threshold voltage (alias for VTO)	V	0
VTO	Zero-bias threshold voltage	V	0

2.3.20.5. Level 9 MOSFET Tables (BSIM3)

For complete documentation of the BSIM3 model, see the users' manual for the BSIM3, available for download at <http://bsim.berkeley.edu/models/bsim4/bsim3/>. Xyce implements Version 3.2.2 of the BSIM3.

In addition to the parameters shown in table 2-100, the BSIM3 supports a vector parameter for the initial conditions. IC1 through IC3 may therefore be specified compactly as IC=<ic1>,<ic2>,<ic3>.

NOTE: Many BSIM3 parameters listed in tables 2-100 and 2-101 as having default values of zero are actually replaced with internally computed defaults if not given. Specifying zero in your model card will override this internal computation. It is recommended that you only set model parameters that you are actually changing from defaults and that you not generate model cards containing default values from the tables.

Table 2-100. BSIM3 Device Instance Parameters

Parameter	Description	Units	Default
<i>Control Parameters</i>			
M	Multiplier for M devices connected in parallel	–	1
NQSMOD	Flag for NQS model	–	0
<i>Geometry Parameters</i>			
AD	Drain diffusion area	m ²	0
AS	Source diffusion area	m ²	0
L	Channel length	m	0
NRD	Multiplier for RSH to yield parasitic resistance of drain	□	1
NRS	Multiplier for RSH to yield parasitic resistance of source	□	1
PD	Drain diffusion perimeter	m	0
PS	Source diffusion perimeter	m	0
W	Channel width	m	0
<i>Temperature Parameters</i>			
TEMP	Device temperature	°C	Ambient Temperature
<i>Voltage Parameters</i>			
IC1	Initial condition on Vds	V	0
IC2	Initial condition on Vgs	V	0
IC3	Initial condition on Vbs	V	0
OFF	Initial condition of no voltage drops across device	logical (T/F)	false

Table 2-101. BSIM3 Device Model Parameters

Parameter	Description	Units	Default
<i>Bin Parameters</i>			
LMAX	Maximum channel length	m	1
LMIN	Minimum channel length	m	0
WMAX	Maximum channel width	m	1
WMIN	Minimum channel width	m	0
<i>Capacitance Parameters</i>			
ACDE	Exponential coefficient for charge thickness in capmod = 3 for accumulation and depletion regions	m/V	1
CF	Firing field capacitance	F/m	0
CGBO	Gate-bulk overlap capacitance per unit channel length	F/m	0
CGDL	Light-doped drain-gate region overlap capacitance	F/m	0
CGDO	Non-LLD region drain-gate overlap capacitance per unit channel length	F/m	0
CGSL	Light-doped source-gate region overlap capacitance	F/m	0
CGSO	Non-LLD region source-gate overlap capacitance per unit channel length	F/m	0
CJ	Bulk p-n zero-bias bottom capacitance/area	F/m ²	0.0005
CJSW	Bulk p-n zero-bias sidewall capacitance/area	F/m ²	5e-10
CJSWG	Source/grain gate sidewall junction capacitance per unit width	F/m	0
CKAPPA	Coefficient for lightly doped region overlap capacitance firing field capacitance	F/m	0.6
CLC	Constant term for short-channel model	m	1e-07
CLE	Exponential term for the short-channel model	–	0.6
DLC	Length offset fitting parameter from C-V	m	0
DWC	Width offset fitting parameter from C-V	m	0
MJSWG	Source/grain gate sidewall junction capacitance grading coefficient	–	0
MOIN	Coefficient for the gate-bias dependent surface potential	–	15
NOFF	CV parameter in Vgsteff,CV for weak to strong inversion	–	1
PBSW	Source/drain side junction built-in potential	V	1
PBSWG	Source/drain gate sidewall junction built-in potential	V	0
VFBCV	Flat-band voltage parameter (for CAPMOD = 0 only)	V	-1
VOFFCV	CV parameter in Vgsteff,CV for weak to strong inversion	V	0
XPART	Charge partitioning rate flag	–	0

Table 2-101. BSIM3 Device Model Parameters

Parameter	Description	Units	Default
<i>Control Parameters</i>			
BINUNIT	Binning unit selector	–	1
CAPMOD	Flag for capacitance models	–	3
MOBMOD	Mobility model selector	–	1
NOIMOD	Flag for noise models	–	1
PARAMCHK	Parameter value check	–	0
VERSION	Version number	–	'3.2.2'
<i>DC Parameters</i>			
A0	Bulk charge effect coefficient for channel length	–	1
A1	First non-saturation effect parameter	V ⁻¹	0
A2	Second non-saturation factor	–	1
AGS	Gate-bias coefficient of abulk	V ⁻¹	0
ALPHA0	First parameter of impact-ionization current	m/V	0
ALPHA1	Isub parameter for length scaling	V ⁻¹	0
B0	Bulk charge effect coefficient for channel width	m	0
B1	Bulk charge effect offset	m	0
BETA0	Second parameter of impact-ionization current	V	30
CDSC	Drain/source to channel coupling capacitance	F/m ²	0.00024
CDSCB	Body-bias sensitivity of CDSC	F/(Vm ²)	0
CDSCD	Drain-bias sensitivity of CDSC	F/(Vm ²)	0
CIT	Interface trap capacitance	F/m ²	0
DELTA	Effective Vds parameter	V	0.01
DROUT	L-depedance Coefficient of the DIBL correction parameter in Rout	–	0.56
DSUB	DIBL coefficient exponent in subthreshold region	–	0
DVT0	First coefficient of short-channel effect effect on threshold voltage	–	2.2
DVT0W	First coefficient of narrow-width effect effect on threshold voltage for small channel length	m ⁻¹	0
DVT1	Second coefficient of short-channel effect effect on threshold voltage	–	0.53
DVT1W	Second coefficient of narrow-width effect effect on threshold voltage for small channel length	m ⁻¹	5.3e+06
DVT2	Body-bias coefficient of short-channel effect effect on threshold voltage	V ⁻¹	-0.032
DVT2W	Body-bias coefficient of narrow-width effect effect on threshold voltage for small channel length	V ⁻¹	-0.032
DWB	Coefficient of substrate body bias dependence of Weff	m/V ^{1/2}	0

Table 2-101. BSIM3 Device Model Parameters

Parameter	Description	Units	Default
DWG	Coefficient of gate dependence of W_{eff}	$m/V^{1/2}$	0
ETA0	DIBL coefficient in subthreshold region	–	0.08
ETAB	Body-bias coefficient for the subthreshold DIBL effect	V^{-1}	-0.07
IJTH	Diode limiting current	A	0.1
JSW	Sidewall saturation current per unit length	A/m	0
K1	First-order body effect coefficient	$V^{1/2}$	0
K2	second-order body effect coefficient	–	0
K3	Narrow width coefficient	–	80
K3B	Body effect coefficient of K3	V^{-1}	0
KETA	Body-bias coefficient of bulk charge effect	V^{-1}	-0.047
LINT	Length of offset fitting parameter from I-V without bias	m	0
LINTNOI	lint offset for noise calculation	m	0
NFACTOR	Subthreshold swing factor	–	1
NGATE	Poly gate doping concentration	cm^{-3}	0
NLX	Lateral non-uniform doping parameter	m	1.74e-07
PCLM	Channel length modulation parameter	–	1.3
PDIBLC1	First output resistance DIBL effect correction parameter	–	0.39
PDIBLC2	Second output resistance DIBL effect correction parameter	–	0.0086
PDIBLCB	Body effect coefficient of DIBL correction parameter	V^{-1}	0
PRWB	Body effect coefficient of RDSW	$V^{-1/2}$	0
PRWG	Gate-bias effect coefficient of RDSW	V^{-1}	0
PSCBE1	First substrate current body effect parameter	Vm^{-1}	4.24e+08
PSCBE2	second substrate current body effect parameter	Vm^{-1}	1e-05
PVAG	Gate dependence of early voltage	–	0
RDSW	Parasitic resistance per unit width	$\Omega \mu m$	0
UA	First-order mobility degradation coefficient	m/V	2.25e-09
UB	First-order mobility degradation coefficient	m^2/V^2	5.87e-19
UC	Body effect of mobility degradation coefficient	m/V^2	0
VBM	Maximum applied body-bias in threshold voltage calculation	V	-3
VFB	Flat-band voltage	V	0
VOFF	Offset voltage in the subthreshold region at large W and L	V	-0.08
VSAT	Saturation velocity at temp = TNOM	m/s	80000
VTH0	Threshold voltage at $V_{bs} = 0$ for large L	V	0

Table 2-101. BSIM3 Device Model Parameters

Parameter	Description	Units	Default
W0	Narrow-width parameter	m	2.5e-06
WINT	Width-offset fitting parameter from I-V without bias	m	0
WR	Width offset from Weff for Rds Calculation	-	1
<i>Dependency Parameters</i>			
LA0	Length dependence of A0	m	0
LA1	Length dependence of A1	m/V	0
LA2	Length dependence of A2	m	0
LACDE	Length dependence of ACDE	m ² /V	0
LAGS	Length dependence of AGS	m/V	0
LALPHA0	Length dependence of ALPHA0	m ² /V	0
LALPHA1	Length dependence of ALPHA1	m/V	0
LAT	Length dependence of AT	m ² /s	0
LB0	Length dependence of B0	m ²	0
LB1	Length dependence of B1	m ²	0
LBETA0	Length dependence of BETA0	Vm	0
LCDSC	Length dependence of CDSC	F/m	0
LCDSB	Length dependence of CDSB	F/(Vm)	0
LCDSCD	Length dependence of CDSCD	F/(Vm)	0
LCF	Length dependence of CF	F	0
LCGDL	Length dependence of CGDL	F	0
LCGSL	Length dependence of CGSL	F	0
LCIT	Length dependence of CIT	F/m	0
LCKAPPA	Length dependence of CKAPPA	F	0
LCLC	Length dependence of CLC	m ²	0
LCLE	Length dependence of CLE	m	0
LDELTA	Length dependence of DELTA	Vm	0
LDROUT	Length dependence of DROUT	m	0
LDSUB	Length dependence of DSUB	m	0
LDVT0	Length dependence of DVT0	m	0
LDVT0W	Length dependence of DVT0W	-	0
LDVT1	Length dependence of DVT1	m	0
LDVT1W	Length dependence of DVT1W	-	0
LDVT2	Length dependence of DVT2	m/V	0
LDVT2W	Length dependence of DVT2W	m/V	0
LDWB	Length dependence of DWB	m ² /V ^{1/2}	0
LDWG	Length dependence of DWG	m ² /V ^{1/2}	0

Table 2-101. BSIM3 Device Model Parameters

Parameter	Description	Units	Default
LELM	Length dependence of ELM	m	0
LETA0	Length dependence of ETA0	m	0
LETAB	Length dependence of ETAB	m/V	0
LGAMMA1	Length dependence of GAMMA1	$V^{1/2}m$	0
LGAMMA2	Length dependence of GAMMA2	$V^{1/2}m$	0
LK1	Length dependence of K1	$V^{1/2}m$	0
LK2	Length dependence of K2	m	0
LK3	Length dependence of K3	m	0
LK3B	Length dependence of K3B	m/V	0
LKETA	Length dependence of KETA	m/V	0
LKT1	Length dependence of KT1	Vm	0
LKT1L	Length dependence of KT1L	Vm^2	0
LKT2	Length dependence of KT2	m	0
LMOIN	Length dependence of MOIN	m	0
LNCH	Length dependence of NCH	m/cm^3	0
LNFACTOR	Length dependence of NFACTOR	m	0
LNGATE	Length dependence of NGATE	m/cm^3	0
LNLX	Length dependence of NLX	m^2	0
LNOFF	Length dependence of NOFF	m	0
LNSUB	Length dependence of NSUB	m/cm^3	0
LPCLM	Length dependence of PCLM	m	0
LPDIBLC1	Length dependence of PDIBLC1	m	0
LPDIBLC2	Length dependence of PDIBLC2	m	0
LPDIBLCB	Length dependence of PDIBLCB	m/V	0
LPRT	Length dependence of PRT	$\Omega \mu m m$	0
LPRWB	Length dependence of PRWB	$m/V^{1/2}$	0
LPRWG	Length dependence of PRWG	m/V	0
LPSCBE1	Length dependence of PSCBE1	V	0
LPSCBE2	Length dependence of PSCBE2	V	0
LPVAG	Length dependence of PVAG	m	0
LRDSW	Length dependence of RDSW	$\Omega \mu m m$	0
LU0	Length dependence of U0	$m/(Vcm^2s)$	0
LUA	Length dependence of UA	m^2/V	0
LUA1	Length dependence of UA1	m^2/V	0
LUB	Length dependence of UB	m^3/V^2	0
LUB1	Length dependence of UB1	m^3/V^2	0

Table 2-101. BSIM3 Device Model Parameters

Parameter	Description	Units	Default
LUC	Length dependence of UC	m^2/V^2	0
LUC1	Length dependence of UC1	$m^2/(^{\circ}CV^2)$	0
LUTE	Length dependence of UTE	m	0
LVBM	Length dependence of VBM	Vm	0
LVBX	Length dependence of VBX	Vm	0
LVFB	Length dependence of VFB	Vm	0
LVFBCV	Length dependence of VFBCV	Vm	0
LVOFF	Length dependence of VOFF	Vm	0
LVOFFCV	Length dependence of VOFFCV	Vm	0
LVSAT	Length dependence of VSAT	m^2/s	0
LVTH0	Length dependence of VTH0	Vm	0
LW0	Length dependence of W0	m^2	0
LWR	Length dependence of WR	m	0
LXJ	Length dependence of XJ	m^2	0
LXT	Length dependence of XT	m^2	0
PA0	Cross-term dependence of A0	m^2	0
PA1	Cross-term dependence of A1	m^2/V	0
PA2	Cross-term dependence of A2	m^2	0
PACDE	Cross-term dependence of ACDE	m^3/V	0
PAGS	Cross-term dependence of AGS	m^2/V	0
PALPHA0	Cross-term dependence of ALPHA0	m^3/V	0
PALPHA1	Cross-term dependence of ALPHA1	m^2/V	0
PAT	Cross-term dependence of AT	m^3/s	0
PB0	Cross-term dependence of B0	m^3	0
PB1	Cross-term dependence of B1	m^3	0
PBETA0	Cross-term dependence of BETA0	Vm^2	0
PCDSC	Cross-term dependence of CDSC	F	0
PCDSCB	Cross-term dependence of CDSCB	F/V	0
PCDSCD	Cross-term dependence of CDSCD	F/V	0
PCF	Cross-term dependence of CF	Fm	0
PCGDL	Cross-term dependence of CGDL	Fm	0
PCGSL	Cross-term dependence of CGSL	Fm	0
PCIT	Cross-term dependence of CIT	F	0
PCKAPPA	Cross-term dependence of CKAPPA	Fm	0
PCLC	Cross-term dependence of CLC	m^3	0
PCLE	Cross-term dependence of CLE	m^2	0

Table 2-101. BSIM3 Device Model Parameters

Parameter	Description	Units	Default
PDELTA	Cross-term dependence of DELTA	Vm^2	0
PDROUT	Cross-term dependence of DROUT	m^2	0
PDSUB	Cross-term dependence of DSUB	m^2	0
PDVT0	Cross-term dependence of DVT0	m^2	0
PDVT0W	Cross-term dependence of DVT0W	m	0
PDVT1	Cross-term dependence of DVT1	m^2	0
PDVT1W	Cross-term dependence of DVT1W	m	0
PDVT2	Cross-term dependence of DVT2	m^2/V	0
PDVT2W	Cross-term dependence of DVT2W	m^2/V	0
PDWB	Cross-term dependence of DWB	$m^3/V^{1/2}$	0
PDWG	Cross-term dependence of DWG	$m^3/V^{1/2}$	0
PELM	Cross-term dependence of ELM	m^2	0
PETA0	Cross-term dependence of ETA0	m^2	0
PETAB	Cross-term dependence of ETAB	m^2/V	0
PGAMMA1	Cross-term dependence of GAMMA1	$V^{1/2}m^2$	0
PGAMMA2	Cross-term dependence of GAMMA2	$V^{1/2}m^2$	0
PK1	Cross-term dependence of K1	$V^{1/2}m^2$	0
PK2	Cross-term dependence of K2	m^2	0
PK3	Cross-term dependence of K3	m^2	0
PK3B	Cross-term dependence of K3B	m^2/V	0
PKETA	Cross-term dependence of KETA	m^2/V	0
PKT1	Cross-term dependence of KT1	Vm^2	0
PKT1L	Cross-term dependence of KT1L	Vm^3	0
PKT2	Cross-term dependence of KT2	m^2	0
PMOIN	Cross-term dependence of MOIN	m^2	0
PNCH	Cross-term dependence of NCH	m^2/cm^3	0
PNFACTOR	Cross-term dependence of NFACTOR	m^2	0
PNGATE	Cross-term dependence of NGATE	m^2/cm^3	0
PNLX	Cross-term dependence of NLX	m^3	0
PNOFF	Cross-term dependence of NOFF	m^2	0
PNSUB	Cross-term dependence of NSUB	m^2/cm^3	0
PPCLM	Cross-term dependence of PCLM	m^2	0
PPDIBLC1	Cross-term dependence of PDIBLC1	m^2	0
PPDIBLC2	Cross-term dependence of PDIBLC2	m^2	0
PPDIBLCB	Cross-term dependence of PDIBLCB	m^2/V	0

Table 2-101. BSIM3 Device Model Parameters

Parameter	Description	Units	Default
PPRT	Cross-term dependence of PRT	$\frac{\Omega \mu\text{m}}{\text{m}^2}$	0
PPRWB	Cross-term dependence of PRWB	$\text{m}^2/\text{V}^{1/2}$	0
PPRWG	Cross-term dependence of PRWG	m^2/V	0
PPSCBE1	Cross-term dependence of PSCBE1	Vm	0
PPSCBE2	Cross-term dependence of PSCBE2	Vm	0
PPVAG	Cross-term dependence of PVAG	m^2	0
PRDSW	Cross-term dependence of RDSW	$\frac{\Omega \mu\text{m}}{\text{m}^2}$	0
PU0	Cross-term dependence of U0	$\text{m}^2/(\text{Vcm}^2\text{s})0$	
PUA	Cross-term dependence of UA	m^3/V	0
PUA1	Cross-term dependence of UA1	m^3/V	0
PUB	Cross-term dependence of UB	m^4/V^2	0
PUB1	Cross-term dependence of UB1	m^4/V^2	0
PUC	Cross-term dependence of UC	m^3/V^2	0
PUC1	Cross-term dependence of UC1	$\text{m}^3/(\text{°CV}^2)$	0
PUTE	Cross-term dependence of UTE	m^2	0
PVBM	Cross-term dependence of VBM	Vm^2	0
PVBX	Cross-term dependence of VBX	Vm^2	0
PVFB	Cross-term dependence of VFB	Vm^2	0
PVFBCV	Cross-term dependence of VFBCV	Vm^2	0
PVOFF	Cross-term dependence of VOFF	Vm^2	0
PVOFFCV	Cross-term dependence of VOFFCV	Vm^2	0
PVSAT	Cross-term dependence of VSAT	m^3/s	0
PVTH0	Cross-term dependence of VTH0	Vm^2	0
PW0	Cross-term dependence of W0	m^3	0
PWR	Cross-term dependence of WR	m^2	0
PXJ	Cross-term dependence of XJ	m^3	0
PXT	Cross-term dependence of XT	m^3	0
WA0	Width dependence of A0	m	0
WA1	Width dependence of A1	m/V	0
WA2	Width dependence of A2	m	0
WACDE	Width dependence of ACDE	m^2/V	0
WAGS	Width dependence of AGS	m/V	0
WALPHA0	Width dependence of ALPHA0	m^2/V	0
WALPHA1	Width dependence of ALPHA1	m/V	0

Table 2-101. BSIM3 Device Model Parameters

Parameter	Description	Units	Default
WAT	Width dependence of AT	m ² /s	0
WB0	Width dependence of B0	m ²	0
WB1	Width dependence of B1	m ²	0
WBETA0	Width dependence of BETA0	Vm	0
WCDSC	Width dependence of CDSC	F/m	0
WCDSCB	Width dependence of CDSCB	F/(Vm)	0
WCDSCD	Width dependence of CDSCD	F/(Vm)	0
WCF	Width dependence of CF	F	0
WCGDL	Width dependence of CGDL	F	0
WCGSL	Width dependence of CGSL	F	0
WCIT	Width dependence of CIT	F/m	0
WCKAPPA	Width dependence of CKAPPA	F	0
WCLC	Width dependence of CLC	m ²	0
WCLE	Width dependence of CLE	m	0
WDELTA	Width dependence of DELTA	Vm	0
WDROUT	Width dependence of DROUT	m	0
WDSUB	Width dependence of DSUB	m	0
WDVT0	Width dependence of DVT0	m	0
WDVT0W	Width dependence of DVT0W	–	0
WDVT1	Width dependence of DVT1	m	0
WDVT1W	Width dependence of DVT1W	–	0
WDVT2	Width dependence of DVT2	m/V	0
WDVT2W	Width dependence of DVT2W	m/V	0
WDWB	Width dependence of DWB	m ² /V ^{1/2}	0
WDWG	Width dependence of DWG	m ² /V ^{1/2}	0
WELM	Width dependence of ELM	m	0
WETA0	Width dependence of ETA0	m	0
WETAB	Width dependence of ETAB	m/V	0
WGAMMA1	Width dependence of GAMMA1	V ^{1/2} m	0
WGAMMA2	Width dependence of GAMMA2	V ^{1/2} m	0
WK1	Width dependence of K1	V ^{1/2} m	0
WK2	Width dependence of K2	m	0
WK3	Width dependence of K3	m	0
WK3B	Width dependence of K3B	m/V	0
WKETA	Width dependence of KETA	m/V	0
WKT1	Width dependence of KT1	Vm	0

Table 2-101. BSIM3 Device Model Parameters

Parameter	Description	Units	Default
WKT1L	Width dependence of KT1L	Vm ²	0
WKT2	Width dependence of KT2	m	0
WMOIN	Width dependence of MOIN	m	0
WNCH	Width dependence of NCH	m/cm ³	0
WNFACTOR	Width dependence of NFACTOR	m	0
WNGATE	Width dependence of NGATE	m/cm ³	0
WNLX	Width dependence of NLX	m ²	0
WNOFF	Width dependence of NOFF	m	0
WNSUB	Width dependence of NSUB	m/cm ³	0
WPCLM	Width dependence of PCLM	m	0
WPDIBLC1	Width dependence of PDIBLC1	m	0
WPDIBLC2	Width dependence of PDIBLC2	m	0
WPDIBLCB	Width dependence of PDIBLCB	m/V	0
WPRT	Width dependence of PRT	Ω μm m	0
WPRWB	Width dependence of PRWB	m/V ^{1/2}	0
WPRWG	Width dependence of PRWG	m/V	0
WPSCBE1	Width dependence of PSCBE1	V	0
WPSCBE2	Width dependence of PSCBE2	V	0
WPVAG	Width dependence of PVAG	m	0
WRDSW	Width dependence of RDSW	Ω μm m	0
WU0	Width dependence of U0	m/(Vcm ² s)	0
WUA	Width dependence of UA	m ² /V	0
WUA1	Width dependence of UA1	m ² /V	0
WUB	Width dependence of UB	m ³ /V ²	0
WUB1	Width dependence of UB1	m ³ /V ²	0
WUC	Width dependence of UC	m ² /V ²	0
WUC1	Width dependence of UC1	m ² /(°CV ²)	0
WUTE	Width dependence of UTE	m	0
WVBM	Width dependence of VBM	Vm	0
WVBX	Width dependence of VBX	Vm	0
WVFB	Width dependence of VFB	Vm	0
WVFCV	Width dependence of VFBCV	Vm	0
WVOFF	Width dependence of VOFF	Vm	0
WVOFFCV	Width dependence of VOFFCV	Vm	0
WVSAT	Width dependence of VSAT	m ² /s	0
WVTH0	Width dependence of VTH0	Vm	0

Table 2-101. BSIM3 Device Model Parameters

Parameter	Description	Units	Default
WW0	Width dependence of W0	m ²	0
WWR	Width dependence of WR	m	0
WXJ	Width dependence of XJ	m ²	0
WXT	Width dependence of XT	m ²	0
<i>Doping Parameters</i>			
MJ	Bulk p-n bottom grading coefficient	–	0.5
MJSW	Bulk p-n sidewall grading coefficient	–	0.33
NSUB	Substrate doping density	cm ⁻³	6e+16
<i>Flicker and Thermal Noise Parameters</i>			
AF	Flicker noise exponent	–	1
EF	Flicker exponent	–	1
EM	Saturation field	Vm ⁻¹	4.1e+07
KF	Flicker noise coefficient	–	0
NOIA	Noise parameter a	–	0
NOIB	Noise parameter b	–	0
NOIC	Noise parameter c	–	0
<i>Geometry Parameters</i>			
L	Channel length	m	5e-06
LL	Coefficient of length dependence for length offset	m ^{LLN}	0
LLC	Coefficient of length dependence for CV channel length offset	m ^{LLN}	0
LLN	Power of length dependence for length offset	–	0
LW	Coefficient of width dependence for length offset	m ^{LWN}	0
LWC	Coefficient of width dependence for channel length offset	m ^{LWN}	0
LWL	Coefficient of length and width cross term for length offset	m ^{LLN+LWN}	0
LWLC	Coefficient of length and width dependence for CV channel length offset	m ^{LLN+LWN}	0
LWN	Power of width dependence for length offset	–	0
TOX	Gate oxide thickness	m	1.5e-08
W	Channel width	m	5e-06
WL	Coefficient of length dependence for width offset	m ^{WLN}	0
WLC	Coefficient of length dependence for CV channel width offset	m ^{WLN}	0
WLN	Power of length dependence of width offset	–	0
WW	Coefficient of width dependence for width offset	m ^{WWN}	0

Table 2-101. BSIM3 Device Model Parameters

Parameter	Description	Units	Default
WWC	Coefficient of width dependence for CV channel width offset	m^{WWN}	0
WWL	Coefficient of length and width cross term for width offset	$m^{WLN+WWN}$	0
WWLC	Coefficient of length and width dependence for CV channel width offset	$m^{WLN+WWN}$	0
WWN	Power of width dependence of width offset	-	0
XJ	Junction depth	m	1.5e-07
<i>NQS Parameters</i>			
ELM	Elmore constant of the channel	-	5
<i>Resistance Parameters</i>			
RSH	Drain,source diffusion sheet resistance	Ω	0
<i>Process Parameters</i>			
GAMMA1	Body effect coefficient near the surface	$V^{1/2}$	0
GAMMA2	Body effect coefficient in the bulk	$V^{1/2}$	0
JS	Bulk p-n saturation current density	A/m^2	0.0001
NCH	Channel doping concentration	cm^{-3}	1.7e+17
TOXM	Gate oxide thickness used in extraction	m	0
U0	Surface mobility	$1/(Vcm^2s)$	0
VBX	Vbs at which the depletion region = XT	V	0
XT	Doping depth	m	1.55e-07
<i>Temperature Parameters</i>			
AT	Temperature coefficient for saturation velocity	m/s	33000
KT1	Temperature coefficient for threshold voltage	V	-0.11
KT1L	Channel length dependence of the temperature coefficient for the threshold voltage	Vm	0
KT2	Body-bias coefficient fo the threshold voltage temperature effect	-	0.022
NJ	Emission coefficient of junction	-	1
PRT	Temperature coefficient for RDSW	$\Omega \mu m$	0
TCJ	Temperature coefficient of Cj	K^{-1}	0
TCJSW	Temperature coefficient of Cswj	K^{-1}	0
TCJSWG	Temperature coefficient of Cjswg	K^{-1}	0
TNOM	Nominal device temperature	$^{\circ}C$	Ambient Temperature
TPB	Temperature coefficient of Pb	V/K	0
TPBSW	Temperature coefficient of Pbsw	V/K	0

Table 2-101. BSIM3 Device Model Parameters

Parameter	Description	Units	Default
TPBSWG	Temperature coefficient of Pbswg	V/K	0
UA1	Temperature coefficient for UA	m/V	4.31e-09
UB1	Temperature coefficient for UB	m ² /V ²	-7.61e-18
UC1	Temperature coefficient for UC	m/(°CV ²)	0
UTE	Mobility temerature exponent	–	-1.5
XTI	Junction current temperature exponent coefficient	–	3
<i>Voltage Parameters</i>			
PB	Bulk p-n bottom potential	V	1

2.3.20.6. Level 10 MOSFET Tables (BSIM-SOI)

For complete documentation of the BSIM-SOI model, see the users' manual for the BSIM-SOI, available for download at <http://bsim.berkeley.edu/models/bsimsoi/>. Xyce implements Version 3.2 of the BSIM-SOI, you will have to get the documentation from the FTP archive on the Berkeley site.

In addition to the parameters shown in table 2-102, the BSIM3SOI supports a vector parameter for the initial conditions. IC1 through IC5 may therefore be specified compactly as IC=<ic1>,<ic2>,<ic3>,<ic4>,<ic5>.

NOTE: Many BSIM SOI parameters listed in tables 2-102 and 2-103 as having default values of zero are actually replaced with internally computed defaults if not given. Specifying zero in your model card will override this internal computation. It is recommended that you only set model parameters that you are actually changing from defaults and that you not generate model cards containing default values from the tables.

Table 2-102. BSIM3 SOI Device Instance Parameters

Parameter	Description	Units	Default
BJTOFF	BJT on/off flag	logical (T/F)	0
DEBUG	BJT on/off flag	logical (T/F)	0
TNODEOUT	Flag indicating external temp node	logical (T/F)	0
VLDEBUG		logical (T/F)	false
<i>Control Parameters</i>			
M	Multiplier for M devices connected in parallel	–	1
SOIMOD	SIO model selector,SOIMOD=0: BSIMPD,SOIMOD=1: undefined model for PD and FE,SOIMOD=2: ideal FD	–	0
<i>DC Parameters</i>			
VBSUSR	Vbs specified by user	V	0
<i>Geometry Parameters</i>			
AD	Drain diffusion area	m ²	0
AEBCP	Substrate to body overlap area for bc parasitics	m ²	0
AGBCP	Gate to body overlap area for bc parasitics	m ²	0
AS	Source diffusion area	m ²	0
FRBODY	Layout dependent body-resistance coefficient	–	1
L	Channel length	m	5e-06
NBC	Number of body contact isolation edge	–	0
NRB	Number of squares in body	–	1

Table 2-102. BSIM3 SOI Device Instance Parameters

Parameter	Description	Units	Default
NRD	Multiplier for RSH to yield parasitic resistance of drain	□	1
NRS	Multiplier for RSH to yield parasitic resistance of source	□	1
NSEG	Number segments for width partitioning	–	1
PD	Drain diffusion perimeter	m	0
PDBCP	Perimeter length for bc parasitics at drain side	m	0
PS	Source diffusion perimeter	m	0
PSBCP	Perimeter length for bc parasitics at source side	m	0
W	Channel width	m	5e-06
<i>RF Parameters</i>			
RGATEMOD	Gate resistance model selector	–	0
<i>Temperature Parameters</i>			
CTH0	Thermal capacitance	F	0
DTEMP	Device delta temperature	°C	0
RTH0	normalized thermal resistance	Ω	0
TEMP	Device temperature	°C	Ambient Temperature
<i>Voltage Parameters</i>			
IC1	Initial condition on Vds	V	0
IC2	Initial condition on Vgs	V	0
IC3	Initial condition on Vbs	V	0
IC4	Initial condition on Ves	V	0
IC5	Initial condition on Vps	V	0
OFF	Initial condition of no voltage drops accross device	logical (T/F)	false

Table 2-103. BSIM3 SOI Device Model Parameters

Parameter	Description	Units	Default
DELTAVOX	The smoothing parameter in the Vox smoothing function	–	0
DTOXCV	Delta oxide thickness in meters in CapMod3	m	0
FNOIMOD	Flicker noise model selector	–	1
IGBMOD	Flicker noise model selector	–	0
IGCMOD	Gate-channel tunneling current model selector	–	0
KB1	Scaling factor for backgate charge	–	1

Table 2-103. BSIM3 SOI Device Model Parameters

Parameter	Description	Units	Default
NOIF	Floating body excess noise ideality factor	–	1
NTNOI	Thermal noise parameter	–	1
POXEDGE	Factor for the gate edge T_{ox}	–	1
RNOIA	Thermal noise coefficient	–	0.577
RNOIB	Thermal noise coefficient	–	0.37
RSHG	Gate sheet resistance	–	0.1
TNOIA	Thermal noise parameter	–	1.5
TNOIB	Thermal noise parameter	–	3.5
TNOIMOD	Thermal noise model selector	–	0
VBS0FD	Lower bound of built-in potential lowering for FD operation	V	0.5
VBS0PD	Upper bound of built-in potential lowering for FD operation	–	0
VOXH	The limit of V_{ox} in gate current calculation	–	0
VTHO	Threshold voltage	–	0
<i>Bin Parameters</i>			
LMAX	Maximum channel length	m	1
LMIN	Minimum channel length	m	0
WMAX	Maximum channel width	m	1
WMIN	Minimum channel width	m	0
<i>Capacitance Parameters</i>			
ACDE	Exponential coefficient for charge thickness in capmod = 3 for accumulation and depletion regions	m/V	1
ASD	Source/Drain bottom diffusion smoothing parameter	–	0.3
CF	Firing field capacitance	F/m	0
CGDL	Light-doped drain-gate region overlap capacitance	F/m	0
CGDO	Non-LLD region drain-gate overlap capacitance per unit channel length	F/m	0
CGEO	Gate substrate overlap capacitance per unit channel length	F/m	0
CGSL	Light-doped source-gate region overlap capacitance	F/m	0
CGSO	Non-LLD region source-gate overlap capacitance per unit channel length	F/m	0
CJSWG	Source/grain gate sidewall junction capacitance per unit width	F/m	1e-10
CKAPPA	Coefficient for lightly doped region overlap capacitance firing field capacitance	F/m	0.6
CLC	Constant term for short-channel model	m	1e-08

Table 2-103. BSIM3 SOI Device Model Parameters

Parameter	Description	Units	Default
CLE	Exponential term for the short-channel model	–	0
CSDESW	Source/Drain sidewall fringing capacitance per unit length	F/m	0
CSDMIN	Source/Drain bottom diffusion minimum capacitance	V	0
DELVT	Threshold voltage adjust for C-V	V	0
DLBG	Length offset fitting parameter for backgate charge	m	0
DLC	Length offset fitting parameter from C-V	m	0
DLCB	Length offset fitting parameter for body charge	m	0
DWC	Width offset fitting parameter from C-V	m	0
FBODY	Scaling factor for body charge	–	1
LDIF0	Channel length dependency coefficient of diffusion capacitance	–	1
MJSWG	Source/grain gate sidewall junction capacitance grading coefficient	–	0.5
MOIN	Coefficient for the gate-bias dependent surface potential	–	15
NDIF	Power coefficient of channel length dependency for diffusion capacitance	–	-1
NOFF	CV parameter in $V_{gsteff,CV}$ for weak to strong inversion	–	1
PBSWG	Source/drain gate sidewall junction built-in potential	V	0.7
TT	Diffusion capacitance transit time coefficient	s	1e-12
VSDFB	Source/Drain bottom diffusion capacitance flatband voltage	V	0
VSDTH	Source/Drain bottom diffusion capacitance threshold voltage	V	0
XPART	Charge partitioning rate flag	–	0
<i>Control Parameters</i>			
BINUNIT	Binning unit selector	–	1
CAPMOD	Flag for capacitance models	–	2
MOBMOD	Mobility model selector	–	1
PARAMCHK	Parameter value check	–	0
SHMOD	Flag for self-heating,0-no self-heating,1-self-heating	–	0
TEMPMODEL	Specifies the type of parameter interpolation over temperature	–	'NONE'
VERSION	Version number	–	'3.2'
<i>Current Parameters</i>			
AIGC	Parameter for I_{gc}	$(F/g)^{1/2}s/m\emptyset$	

Table 2-103. BSIM3 SOI Device Model Parameters

Parameter	Description	Units	Default
AIGSD	Parameter for Igs,d	$(F/g)^{1/2}s/m\emptyset$	
BIGC	Parameter for Igc	$(F/g)^{1/2}s/m\emptyset$	
BIGSD	Parameter for Igs,d	$(F/g)^{1/2}s/m\emptyset$	
CIGC	Parameter for Igc	V^{-1}	0
CIGSD	Parameter for Igs,d	V^{-1}	0
DLCIG	Delta L for Ig model	V^{-1}	0
NIGC	Parameter for Igc slope	–	1
PIGCD	Parameter for Igc partition	–	1
<i>DC Parameters</i>			
A0	Bulk charge effect coefficient for channel length	–	1
A1	First non-saturation effect parameter	V^{-1}	0
A2	Second non-saturation factor	–	1
AELY	Channel length dependency of early voltage for bipolar current	Vm^{-1}	0
AGIDL	GIDL constant	Ω^{-1}	0
AGS	Gate-bias coefficient of abulk	V^{-1}	0
AHLI	High level injection parameter for bipolar current	–	0
ALPHA0	First parameter of impact-ionization current	m/V	0
B0	Bulk charge effect coefficient for channel width	m	0
B1	Bulk charge effect offset	m	0
BETA0	Second parameter of impact-ionization current	V	0
BETA1	Second Vds dependent parameter of impact ionization current	–	0
BETA2	Third Vds dependent parameter of impact ionization current	V	0.1
BGIDL	GIDL exponential coefficient	Vm^{-1}	0
CDSC	Drain/source to channel coupling capacitance	F/m^2	0.00024
CDSCB	Body-bias sensitivity of CDSC	$F/(Vm^2)$	0
CDSCD	Drain-bias sensitivity of CDSC	$F/(Vm^2)$	0
CIT	Interface trap capacitance	F/m^2	0
DELTA	Effective Vds parameter	V	0.01
DROUT	L-dependance Coefficient of the DIBL correction parameter in Rout	–	0.56
DSUB	DIBL coefficient exponent in subthreshold region	–	0
DVT0	First coefficient of short-channel effect effect on threshold voltage	–	2.2

Table 2-103. BSIM3 SOI Device Model Parameters

Parameter	Description	Units	Default
DVT0W	First coefficient of narrow-width effect effect on threshold voltage for small channel length	m^{-1}	0
DVT1	Second coefficient of short-channel effect effect on threshold voltage	–	0.53
DVT1W	Second coefficient of narrow-width effect effect on threshold voltage for small channel length	m^{-1}	5.3e+06
DVT2	Body-bias coefficient of short-channel effect effect on threshold voltage	V^{-1}	-0.032
DVT2W	Body-bias coefficient of narrow-width effect effect on threshold voltage for small channel length	V^{-1}	-0.032
DWB	Coefficient of substrate body bias dependence of W_{eff}	$m/V^{1/2}$	0
DWBC	Width offset for body contact isolation edge	m	0
DWG	Coefficient of gate dependence of W_{eff}	$m/V^{1/2}$	0
ESATII	Saturation channel electric field for impact ionization current	Vm^{-1}	1e+07
ETA0	DIBL coefficient in subthreshold region	–	0.08
ETAB	Body-bias coefficient for the subthreshold DIBL effect	V^{-1}	-0.07
FBJTII	Fraction of bipolar current affecting the impact ionization	–	0
ISBJT	BJT injection saturation current	A/m^2	1e-06
ISDIF	BOdy to source/drain injection saturation current	A/m^2	0
ISREC	Recombinatin in depletion saturation current	A/m^2	1e-05
ISTUN	Reverse tunneling saturation current	A/m^2	0
K1	First-order body effect coefficient	$V^{1/2}$	0
K1W1	First body effect width dependent parameter	m	0
K1W2	Second body effect width dependent parameter	m	0
K2	second-order body effect coefficient	–	0
K3	Narrow width coefficient	–	0
K3B	Body effect coefficient of K3	V^{-1}	0
KETA	Body-bias coefficient of bulk charge effect	V^{-1}	-0.6
KETAS	Surface potential adjustment for bulk charge effect	V	0
LBJT0	Reference channel length for bipolar current	m	2e-07
LII	Channel length dependent parameter at threshold for impact ionization current	–	0
LINT	Length of offset fitting parameter from I-V without bias	m	0
LN	Electron/hole diffusion length	m	2e-06
NBJT	Power coefficient of channel length	–	1
NDIODE	Diode non-ideality factor	–	1

Table 2-103. BSIM3 SOI Device Model Parameters

Parameter	Description	Units	Default
NFACTOR	Subthreshold swing factor	–	1
NGATE	Poly gate doping concentration	cm ⁻³	0
NGIDL	GIDL V _{ds} enhancement coefficient	V	1.2
NLX	Lateral non-uniform doping parameter	m	1.74e-07
NRECF0	Recombination non-ideality factor at forward bias	–	2
NRECR0	Recombination non-ideality factor at reverse bias	–	10
NTUN	Reverse tunneling non-ideality factor	–	10
PCLM	Channel length modulation parameter	–	1.3
PDIBLC1	First output resistance DIBL effect correction parameter	–	0.39
PDIBLC2	Second output resistance DIBL effect correction parameter	–	0.0086
PDIBLCB	Body effect coefficient of DIBL correction parameter	V ⁻¹	0
PRWB	Body effect coefficient of RDSW	V ^{-1/2}	0
PRWG	Gate-bias effect coefficient of RDSW	V ⁻¹	0
PVAG	Gate dependence of early voltage	–	0
RBODY	Intrinsic body contact sheet resistance	Ω/□	0
RBSH	Intrinsic body contact sheet resistance	Ω/□	0
RDSW	Parasitic resistance per unit width	Ω μm	100
RHALO	Body halo sheet resistance	Ω/m	1e+15
SII0	First V _{gs} dependent parameter of impact ionization current	V ⁻¹	0.5
SII1	Second V _{gs} dependent parameter of impact ionization current	V ⁻¹	0.1
SII2	Third V _{gs} dependent parameter of impact ionization current	–	0
SIID	V _{ds} dependent parameter of drain saturation voltage for impact ionization current	V ⁻¹	0
TII	Temperature dependent parameter for impact ionization current	–	0
UA	First-order mobility degradation coefficient	m/V	2.25e-09
UB	First-order mobility degradation coefficient	m ² /V ²	5.87e-19
UC	Body effect of mobility degradation coefficient	m/V ²	0
VABJT	Early voltage for bipolar current	V	10
VBM	Maximum applied body-bias in threshold voltage calculation	V	-3
VDSATII0	Normal drain saturation voltage at threshold for impact ionization current	V	0.9

Table 2-103. BSIM3 SOI Device Model Parameters

Parameter	Description	Units	Default
VOFF	Offset voltage in the subthreshold region at large W and L	V	-0.08
VREC0	Voltage dependent parameter for recombination current	V	0
VSAT	Saturation velocity at temp = TNOM	m/s	80000
VTH0	Threshold voltage at Vbs = 0 for large L	V	0
VTUN0	Voltage dependent parameter for tunneling current	V	0
W0	Narrow-width parameter	m	2.5e-06
WINT	Width-offset fitting parameter from I-V without bias	m	0
WR	Width offset from Weff for Rds Calculation	-	1
<i>Dependency Parameters</i>			
LA0	Length dependence of A0	m	0
LA1	Length dependence of A1	m/V	0
LA2	Length dependence of A2	m	0
LACDE	Length dependence of ACDE	m ² /V	0
LAELY	Length dependence of AELY	V	0
LAGIDL	Length dependence of AGIDL	m/Ω	0
LAGS	Length dependence of AGS	m/V	0
LAHLI	Length dependence of AHLI	m	0
LAIGC	Length dependence of AIGC	(F/g) ^{1/2} sm/√V	
LAIGSD	Length dependence of AIGSD	(F/g) ^{1/2} sm/√V	
LALPHA0	Length dependence of ALPHA0	m ² /V	0
LALPHAGB1	Length dependence of ALPHAGB1	m/V	0
LALPHAGB2	Length dependence of ALPHAGB2	m/V	0
LAT	Length dependence of AT	m ² /s	0
LB0	Length dependence of B0	m ²	0
LB1	Length dependence of B1	m ²	0
LBETA0	Length dependence of BETA0	Vm	0
LBETA1	Length dependence of BETA1	m	0
LBETA2	Length dependence of BETA2	Vm	0
LBETAGB1	Length dependence of BETAGB1	m/V ²	0
LBETAGB2	Length dependence of BETAGB2	m/V ²	0
LBGIDL	Length dependence of BGIDL	V	0
LBIGC	Length dependence of BIGC	(F/g) ^{1/2} sm/√V	
LBIGSD	Length dependence of BIGSD	(F/g) ^{1/2} sm/√V	
LCDSC	Length dependence of CDSC	F/m	0

Table 2-103. BSIM3 SOI Device Model Parameters

Parameter	Description	Units	Default
LCDSCB	Length dependence of CDSCB	F/(Vm)	0
LCSDCD	Length dependence of CDSCD	F/(Vm)	0
LCGDL	Length dependence of CGDL	F	0
LCGSL	Length dependence of CGSL	F	0
LCIGC	Length dependence of CIGC	m/V	0
LCIGSD	Length dependence of CIGSD	m/V	0
LCIT	Length dependence of CIT	F/m	0
LCKAPPA	Length dependence of CKAPPA	F	0
LDELTA	Length dependence of DELTA	Vm	0
LDELVT	Length dependence of DELVT	Vm	0
LDROUT	Length dependence of DROUT	m	0
LDSUB	Length dependence of DSUB	m	0
LDVT0	Length dependence of DVT0	m	0
LDVT0W	Length dependence of DVT0W	–	0
LDVT1	Length dependence of DVT1	m	0
LDVT1W	Length dependence of DVT1W	–	0
LDVT2	Length dependence of DVT2	m/V	0
LDVT2W	Length dependence of DVT2W	m/V	0
LDWB	Length dependence of DWB	m ² /V ^{1/2}	0
LDWG	Length dependence of DWG	m ² /V ^{1/2}	0
LESATII	Length dependence of ESATII	V	0
LETA0	Length dependence of ETA0	m	0
LETAB	Length dependence of ETAB	m/V	0
LFBJTII	Length dependence of FBJTII	m	0
LISBJT	Length dependence of ISBJT	A/m	0
LISDIF	Length dependence of ISDIF	A/m	0
LISREC	Length dependence of ISREC	A/m	0
LISTUN	Length dependence of ISTUN	A/m	0
LK1	Length dependence of K1	V ^{1/2} m	0
LK1W1	Length dependence of K1W1	m ²	0
LK1W2	Length dependence of K1W2	m ²	0
LK2	Length dependence of K2	m	0
LK3	Length dependence of K3	m	0
LK3B	Length dependence of K3B	m/V	0
LKB1	Length dependence of KB1	m	0
LKETA	Length dependence of KETA	m/V	0

Table 2-103. BSIM3 SOI Device Model Parameters

Parameter	Description	Units	Default
LKETAS	Length dependence of KETAS	Vm	0
LKT1	Length dependence of KT1	Vm	0
LKT1L	Length dependence of KT1L	Vm ²	0
LKT2	Length dependence of KT2	m	0
LLBJT0	Length dependence of LBJT0	m ²	0
LLII	Length dependence of LII	m	0
LMOIN	Length dependence of MOIN	m	0
LNBJT	Length dependence of NBJT	m	0
LNCH	Length dependence of NCH	m/cm ³	0
LNDIF	Length dependence of NDIF	m	0
LNDIODE	Length dependence of NDIODE	m	0
LNFACTOR	Length dependence of NFACTOR	m	0
LNGATE	Length dependence of NGATE	m/cm ³	0
LNGIDL	Length dependence of NGIDL	Vm	0
LNIGC	Length dependence of NIGC	m	0
LNLX	Length dependence of NLX	m ²	0
LNOFF	Length dependence of NOFF	m	0
LNRECF0	Length dependence of NRECF0	m	0
LNRECR0	Length dependence of NRECR0	m	0
LNSUB	Length dependence of NSUB	m/cm ³	0
LNTRECF	Length dependence of NTRECF	m	0
LNTRECR	Length dependence of NTRECR	m	0
LNTUN	Length dependence of NTUN	m	0
LPCLM	Length dependence of PCLM	m	0
LPDIBLC1	Length dependence of PDIBLC1	m	0
LPDIBLC2	Length dependence of PDIBLC2	m	0
LPDIBLCB	Length dependence of PDIBLCB	m/V	0
LPIGCD	Length dependence of PIGCD	m	0
LPOXEDGE	Length dependence of POXEDGE	m	0
LPRT	Length dependence of PRT	Ω μm m	0
LPRWB	Length dependence of PRWB	m/V ^{1/2}	0
LPRWG	Length dependence of PRWG	m/V	0
LPVAG	Length dependence of PVAG	m	0
LRDSW	Length dependence of RDSW	Ω μm m	0
LSII0	Length dependence of SII0	m/V	0
LSII1	Length dependence of SII1	m/V	0

Table 2-103. BSIM3 SOI Device Model Parameters

Parameter	Description	Units	Default
LSII2	Length dependence of SII2	m	0
LSIID	Length dependence of SIID	m/V	0
LU0	Length dependence of U0	m/(Vcm ² s)	0
LUA	Length dependence of UA	m ² /V	0
LUA1	Length dependence of UA1	m ² /V	0
LUB	Length dependence of UB	m ³ /V ²	0
LUB1	Length dependence of UB1	m ³ /V ²	0
LUC	Length dependence of UC	m ² /V ²	0
LUC1	Length dependence of UC1	m ² /(°CV ²)	0
LUTE	Length dependence of UTE	m	0
LVABJT	Length dependence of VABJT	Vm	0
LVDSATII0	Length dependence of VDSATII0	Vm	0
LVOFF	Length dependence of VOFF	Vm	0
LVREC0	Length dependence of VREC0	Vm	0
LVSAT	Length dependence of VSAT	m ² /s	0
LVSDFB	Length dependence of VSDFB	Vm	0
LVSDTH	Length dependence of VSDTH	Vm	0
LVTH0	Length dependence of VTH0	Vm	0
LVTUN0	Length dependence of VTUN0	Vm	0
LW0	Length dependence of W0	m ²	0
LWR	Length dependence of WR	m	0
LXBJT	Length dependence of XBJT	m	0
LXDIF	Length dependence of XDIF	m	0
LXJ	Length dependence of XJ	m ²	0
LXRCRG1	Length dependence of XRCRG1	m	0
LXRCRG2	Length dependence of XRCRG2	m	0
LXREC	Length dependence of XREC	m	0
LXTUN	Length dependence of XTUN	m	0
PA0	Cross-term dependence of A0	m ²	0
PA1	Cross-term dependence of A1	m ² /V	0
PA2	Cross-term dependence of A2	m ²	0
PACDE	Cross-term dependence of ACDE	m ³ /V	0
PAELY	Cross-term dependence of AELY	Vm	0
PAGIDL	Cross-term dependence of AGIDL	m ² /Ω	0
PAGS	Cross-term dependence of AGS	m ² /V	0
PAHLI	Cross-term dependence of AHLI	m ²	0

Table 2-103. BSIM3 SOI Device Model Parameters

Parameter	Description	Units	Default
PAIGC	Cross-term dependence of AIGC	$(F/g)^{1/2}sm^2/V$	0
PAIGSD	Cross-term dependence of AIGSD	$(F/g)^{1/2}sm^2/V$	0
PALPHA0	Cross-term dependence of ALPHA0	m^3/V	0
PALPHAGB1	Cross-term dependence of ALPHAGB1	m^2/V	0
PALPHAGB2	Cross-term dependence of ALPHAGB2	m^2/V	0
PAT	Cross-term dependence of AT	m^3/s	0
PB0	Cross-term dependence of B0	m^3	0
PB1	Cross-term dependence of B1	m^3	0
PBETA0	Cross-term dependence of BETA0	Vm^2	0
PBETA1	Cross-term dependence of BETA1	m^2	0
PBETA2	Cross-term dependence of BETA2	Vm^2	0
PBETAGB1	Cross-term dependence of BETAGB1	m^2/V^2	0
PBETAGB2	Cross-term dependence of BETAGB2	m^2/V^2	0
PBGIDL	Cross-term dependence of BGIDL	Vm	0
PBIGC	Cross-term dependence of BIGC	$(F/g)^{1/2}sm^2/V$	0
PBIGSD	Cross-term dependence of BIGSD	$(F/g)^{1/2}sm^2/V$	0
PCDSC	Cross-term dependence of CDSC	F	0
PCDSCB	Cross-term dependence of CDSCB	F/V	0
PCDSCD	Cross-term dependence of CDSCD	F/V	0
PCGDL	Cross-term dependence of CGDL	Fm	0
PCGSL	Cross-term dependence of CGSL	Fm	0
PCIGC	Cross-term dependence of CIGC	m^2/V	0
PCIGSD	Cross-term dependence of CIGSD	m^2/V	0
PCIT	Cross-term dependence of CIT	F	0
PCKAPPA	Cross-term dependence of CKAPPA	Fm	0
PDELTA	Cross-term dependence of DELTA	Vm^2	0
PDELVT	Cross-term dependence of DELVT	Vm^2	0
PDROUT	Cross-term dependence of DROUT	m^2	0
PDSUB	Cross-term dependence of DSUB	m^2	0
PDVT0	Cross-term dependence of DVT0	m^2	0
PDVT0W	Cross-term dependence of DVT0W	m	0
PDVT1	Cross-term dependence of DVT1	m^2	0
PDVT1W	Cross-term dependence of DVT1W	m	0
PDVT2	Cross-term dependence of DVT2	m^2/V	0
PDVT2W	Cross-term dependence of DVT2W	m^2/V	0
PDWB	Cross-term dependence of DWB	$m^3/V^{1/2}$	0

Table 2-103. BSIM3 SOI Device Model Parameters

Parameter	Description	Units	Default
PDWG	Cross-term dependence of DWG	$m^3/V^{1/2}$	0
PESATII	Cross-term dependence of ESATII	Vm	0
PETA0	Cross-term dependence of ETA0	m^2	0
PETAB	Cross-term dependence of ETAB	m^2/V	0
PFBJTII	Cross-term dependence of FBJTII	m^2	0
PISBJT	Cross-term dependence of ISBJT	A	0
PISDIF	Cross-term dependence of ISDIF	A	0
PISREC	Cross-term dependence of ISREC	A	0
PISTUN	Cross-term dependence of ISTUN	A	0
PK1	Cross-term dependence of K1	$V^{1/2}m^2$	0
PK1W1	Cross-term dependence of K1W1	m^3	0
PK1W2	Cross-term dependence of K1W2	m^3	0
PK2	Cross-term dependence of K2	m^2	0
PK3	Cross-term dependence of K3	m^2	0
PK3B	Cross-term dependence of K3B	m^2/V	0
PKB1	Cross-term dependence of KB1	m^2	0
PKETA	Cross-term dependence of KETA	m^2/V	0
PKETAS	Cross-term dependence of KETAS	Vm^2	0
PKT1	Cross-term dependence of KT1	Vm^2	0
PKT1L	Cross-term dependence of KT1L	Vm^3	0
PKT2	Cross-term dependence of KT2	m^2	0
PLBJT0	Cross-term dependence of LBJT0	m^3	0
PLII	Cross-term dependence of LII	m^2	0
PMOIN	Cross-term dependence of MOIN	m^2	0
PNBJT	Cross-term dependence of NBJT	m^2	0
PNCH	Cross-term dependence of NCH	m^2/cm^3	0
PNDIF	Cross-term dependence of NDIF	m^2	0
PNDIODE	Cross-term dependence of NDIODE	m^2	0
PNFACTOR	Cross-term dependence of NFACTOR	m^2	0
PNGATE	Cross-term dependence of NGATE	m^2/cm^3	0
PNGIDL	Cross-term dependence of NGIDL	Vm^2	0
PNIGC	Cross-term dependence of NIGC	m^2	0
PNLX	Cross-term dependence of NLX	m^3	0
PNOFF	Cross-term dependence of NOFF	m^2	0
PNRECF0	Cross-term dependence of NRECF0	m^2	0
PNRECR0	Cross-term dependence of NRECR0	m^2	0

Table 2-103. BSIM3 SOI Device Model Parameters

Parameter	Description	Units	Default
PNSUB	Cross-term dependence of NSUB	m^2/cm^3	0
PNTRECF	Cross-term dependence of NTRECF	m^2	0
PNTRECR	Cross-term dependence of NTRECR	m^2	0
PNTUN	Cross-term dependence of NTUN	m^2	0
PPCLM	Cross-term dependence of PCLM	m^2	0
PPDIBLC1	Cross-term dependence of PDIBLC1	m^2	0
PPDIBLC2	Cross-term dependence of PDIBLC2	m^2	0
PPDIBLCB	Cross-term dependence of PDIBLCB	m^2/V	0
PPIGCD	Cross-term dependence of PIGCD	m^2	0
PPOXEDGE	Cross-term dependence of POXEDGE	m^2	0
PPRT	Cross-term dependence of PRT	$\frac{\Omega \mu m}{m^2}$	0
PPRWB	Cross-term dependence of PRWB	$m^2/V^{1/2}$	0
PPRWG	Cross-term dependence of PRWG	m^2/V	0
PPVAG	Cross-term dependence of PVAG	m^2	0
PRDSW	Cross-term dependence of RDSW	$\frac{\Omega \mu m}{m^2}$	0
PSII0	Cross-term dependence of SII0	m^2/V	0
PSII1	Cross-term dependence of SII1	m^2/V	0
PSII2	Cross-term dependence of SII2	m^2	0
PSIID	Cross-term dependence of SIID	m^2/V	0
PU0	Cross-term dependence of U0	$m^2/(Vcm^2s)0$	
PUA	Cross-term dependence of UA	m^3/V	0
PUA1	Cross-term dependence of UA1	m^3/V	0
PUB	Cross-term dependence of UB	m^4/V^2	0
PUB1	Cross-term dependence of UB1	m^4/V^2	0
PUC	Cross-term dependence of UC	m^3/V^2	0
PUC1	Cross-term dependence of UC1	$m^3/(^{\circ}CV^2)$	0
PUTE	Cross-term dependence of UTE	m^2	0
PVABJT	Cross-term dependence of VABJT	Vm^2	0
PVDSATII0	Cross-term dependence of VDSATII0	Vm^2	0
PVOFF	Cross-term dependence of VOFF	Vm^2	0
PVREC0	Cross-term dependence of VREC0	Vm^2	0
PVSAT	Cross-term dependence of VSAT	m^3/s	0
PVSDFB	Cross-term dependence of VSDFB	Vm^2	0
PVSDTH	Cross-term dependence of VSDTH	Vm^2	0

Table 2-103. BSIM3 SOI Device Model Parameters

Parameter	Description	Units	Default
PVTH0	Cross-term dependence of VTH0	Vm ²	0
PVTUN0	Cross-term dependence of VTUN0	Vm ²	0
PW0	Cross-term dependence of W0	m ³	0
PWR	Cross-term dependence of WR	m ²	0
PXBJT	Cross-term dependence of XBJT	m ²	0
PXDIF	Cross-term dependence of XDIF	m ²	0
PXJ	Cross-term dependence of XJ	m ³	0
PXRCRG1	Cross-term dependence of XRCRG1	m ²	0
PXRCRG2	Cross-term dependence of XRCRG2	m ²	0
PXREC	Cross-term dependence of XREC	m ²	0
PXTUN	Cross-term dependence of XTUN	m ²	0
WA0	Width dependence of A0	m	0
WA1	Width dependence of A1	m/V	0
WA2	Width dependence of A2	m	0
WACDE	Width dependence of ACDE	m ² /V	0
WAELY	Width dependence of AELY	V	0
WAGIDL	Width dependence of AGIDL	m/Ω	0
WAGS	Width dependence of AGS	m/V	0
WAHLI	Width dependence of AHLI	m	0
WAIGC	Width dependence of AIGC	(F/g) ^{1/2} sm/μV	
WAIGSD	Width dependence of AIGSD	(F/g) ^{1/2} sm/μV	
WALPHA0	Width dependence of ALPHA0	m ² /V	0
WALPHAGB1	Width dependence of ALPHAGB1	m/V	0
WALPHAGB2	Width dependence of ALPHAGB2	m/V	0
WAT	Width dependence of AT	m ² /s	0
WB0	Width dependence of B0	m ²	0
WB1	Width dependence of B1	m ²	0
WBETA0	Width dependence of BETA0	Vm	0
WBETA1	Width dependence of BETA1	m	0
WBETA2	Width dependence of BETA2	Vm	0
WBETAGB1	Width dependence of BETAGB1	m/V ²	0
WBETAGB2	Width dependence of BETAGB2	m/V ²	0
WBGIDL	Width dependence of BGIDL	V	0
WBIGC	Width dependence of BIGC	(F/g) ^{1/2} sm/μV	
WBIGSD	Width dependence of BIGSD	(F/g) ^{1/2} sm/μV	
WCDSC	Width dependence of CDSC	F/m	0

Table 2-103. BSIM3 SOI Device Model Parameters

Parameter	Description	Units	Default
WCDSCB	Width dependence of CDSCB	F/(Vm)	0
WCSDCD	Width dependence of CDSCD	F/(Vm)	0
WCGDL	Width dependence of CGDL	F	0
WCGSL	Width dependence of CGSL	F	0
WCIGC	Width dependence of CIGC	m/V	0
WCIGSD	Width dependence of CIGSD	m/V	0
WCIT	Width dependence of CIT	F/m	0
WCKAPPA	Width dependence of CKAPPA	F	0
WDELTA	Width dependence of DELTA	Vm	0
WDELVT	Width dependence of DELVT	Vm	0
WDROUT	Width dependence of DROUT	m	0
WDSUB	Width dependence of DSUB	m	0
WDVT0	Width dependence of DVT0	m	0
WDVT0W	Width dependence of DVT0W	–	0
WDVT1	Width dependence of DVT1	m	0
WDVT1W	Width dependence of DVT1W	–	0
WDVT2	Width dependence of DVT2	m/V	0
WDVT2W	Width dependence of DVT2W	m/V	0
WDWB	Width dependence of DWB	m ² /V ^{1/2}	0
WDWG	Width dependence of DWG	m ² /V ^{1/2}	0
WESATII	Width dependence of ESATII	V	0
WETA0	Width dependence of ETA0	m	0
WETAB	Width dependence of ETAB	m/V	0
WFBJTII	Width dependence of FBJTII	m	0
WISBJT	Width dependence of ISBJT	A/m	0
WISDIF	Width dependence of ISDIF	A/m	0
WISREC	Width dependence of ISREC	A/m	0
WISTUN	Width dependence of ISTUN	A/m	0
WK1	Width dependence of K1	V ^{1/2} m	0
WK1W1	Width dependence of K1W1	m ²	0
WK1W2	Width dependence of K1W2	m ²	0
WK2	Width dependence of K2	m	0
WK3	Width dependence of K3	m	0
WK3B	Width dependence of K3B	m/V	0
WKB1	Width dependence of KB1	m	0
WKETA	Width dependence of KETA	m/V	0

Table 2-103. BSIM3 SOI Device Model Parameters

Parameter	Description	Units	Default
WKETAS	Width dependence of KETAS	Vm	0
WKT1	Width dependence of KT1	Vm	0
WKT1L	Width dependence of KT1L	Vm ²	0
WKT2	Width dependence of KT2	m	0
WLBJT0	Width dependence of LBJT0	m ²	0
WLII	Width dependence of LII	m	0
WMOIN	Width dependence of MOIN	m	0
WNBJT	Width dependence of NBJT	m	0
WNCH	Width dependence of NCH	m/cm ³	0
WNDIF	Width dependence of NDIF	m	0
WNDIODE	Width dependence of NDIODE	m	0
WNFACTOR	Width dependence of NFACTOR	m	0
WNGATE	Width dependence of NGATE	m/cm ³	0
WNGIDL	Width dependence of NGIDL	Vm	0
WNIGC	Width dependence of NIGC	m	0
WNLX	Width dependence of NLX	m ²	0
WNOFF	Width dependence of NOFF	m	0
WNRECF0	Width dependence of NRECF0	m	0
WNRECR0	Width dependence of NRECR0	m	0
WNSUB	Width dependence of NSUB	m/cm ³	0
WNTRECF	Width dependence of NTRECF	m	0
WNTRECR	Width dependence of NTRECR	m	0
WNTUN	Width dependence of NTUN	m	0
WPCLM	Width dependence of PCLM	m	0
WPDIBLC1	Width dependence of PDIBLC1	m	0
WPDIBLC2	Width dependence of PDIBLC2	m	0
WPDIBLCB	Width dependence of PDIBLCB	m/V	0
WPIGCD	Width dependence of PIGCD	m	0
WPOXEDGE	Width dependence of POXEDGE	m	0
WPRT	Width dependence of PRT	$\Omega \mu\text{m m}$	0
WPRWB	Width dependence of PRWB	m/V ^{1/2}	0
WPRWG	Width dependence of PRWG	m/V	0
WPVAG	Width dependence of PVAG	m	0
WRDSW	Width dependence of RDSW	$\Omega \mu\text{m m}$	0
WSII0	Width dependence of SII0	m/V	0
WSII1	Width dependence of SII1	m/V	0

Table 2-103. BSIM3 SOI Device Model Parameters

Parameter	Description	Units	Default
WSII2	Width dependence of SII2	m	0
WSIID	Width dependence of SIID	m/V	0
WU0	Width dependence of U0	m/(Vcm ² s)	0
WUA	Width dependence of UA	m ² /V	0
WUA1	Width dependence of UA1	m ² /V	0
WUB	Width dependence of UB	m ³ /V ²	0
WUB1	Width dependence of UB1	m ³ /V ²	0
WUC	Width dependence of UC	m ² /V ²	0
WUC1	Width dependence of UC1	m ² /(°CV ²)	0
WUTE	Width dependence of UTE	m	0
WVABJT	Width dependence of VABJT	Vm	0
WVDSATII0	Width dependence of VDSATII0	Vm	0
WVOFF	Width dependence of VOFF	Vm	0
WVREC0	Width dependence of VREC0	Vm	0
WVSAT	Width dependence of VSAT	m ² /s	0
WVSDFB	Width dependence of VSDFB	Vm	0
WVSDTH	Width dependence of VSDTH	Vm	0
WVTH0	Width dependence of VTH0	Vm	0
WVTUN0	Width dependence of VTUN0	Vm	0
WW0	Width dependence of W0	m ²	0
WWR	Width dependence of WR	m	0
WXBJT	Width dependence of XBJT	m	0
WXDIF	Width dependence of XDIF	m	0
WXJ	Width dependence of XJ	m ²	0
WXRCRG1	Width dependence of XRCRG1	m	0
WXRCRG2	Width dependence of XRCRG2	m	0
WXREC	Width dependence of XREC	m	0
WXTUN	Width dependence of XTUN	m	0
<i>Doping Parameters</i>			
NSUB	Substrate doping density	cm ⁻³	6e+16
<i>Flicker and Thermal Noise Parameters</i>			
AF	Flicker noise exponent	-	1
EF	Flicker exponent	-	1
EM	Saturation field	Vm ⁻¹	4.1e+07
KF	Flicker noise coefficient	-	0
NOIA	Noise parameter a	-	0

Table 2-103. BSIM3 SOI Device Model Parameters

Parameter	Description	Units	Default
NOIB	Noise parameter b	–	0
NOIC	Noise parameter c	–	8.75e+09
<i>Geometry Parameters</i>			
L	Channel length	m	5e-06
LL	Coefficient of length dependence for length offset	m^{LLN}	0
LLC	Coefficient of length dependence for CV channel length offset	m^{LLN}	0
LLN	Power of length dependence for length offset	–	1
LW	Coefficient of width dependence for length offset	m^{LWN}	0
LWC	Coefficient of width dependence for channel length offset	m^{LWN}	0
LWL	Coefficient of length and width cross term for length offset	$m^{LLN+LWN}$	0
LWLC	Coefficient of length and width dependence for CV channel length offset	$m^{LLN+LWN}$	0
LWN	Power of width dependence for length offset	–	1
TOX	Gate oxide thickness	m	1e-08
W	Channel width	m	5e-06
WL	Coefficient of length dependence for width offset	m^{WLN}	0
WLC	Coefficient of length dependence for CV channel width offset	m^{WLN}	0
WLN	Power of length dependence of width offset	–	1
WW	Coefficient of width dependence for width offset	m^{WWN}	0
WWC	Coefficient of width dependence for CV channel width offset	m^{WWN}	0
WWL	Coefficient of length and width cross term for width offset	$m^{WLN+WWN}$	0
WWLC	Coefficient of length and width dependence for CV channel width offset	$m^{WLN+WWN}$	0
WWN	Power of width dependence of width offset	–	1
XJ	Junction depth	m	0
<i>Resistance Parameters</i>			
RSH	Drain,source diffusion sheet resistance	Ω	0
<i>Process Parameters</i>			
GAMMA1	Body effect coefficient near the surface	$V^{1/2}$	0
GAMMA2	Body effect coefficient in the bulk	$V^{1/2}$	0
NCH	Channel doping concentration	cm^{-3}	1.7e+17
TBOX	Buried oxide thickness	m	3e-07

Table 2-103. BSIM3 SOI Device Model Parameters

Parameter	Description	Units	Default
TOXM	Gate oxide thickness used in extraction	m	0
TSI	Silicon film thickness	m	1e-07
U0	Surface mobility	1/(Vcm ² s)	0
VBX	Vbs at which the depletion region = XT	V	0
XT	Doping depth	m	1.55e-07
<i>RF Parameters</i>			
BUG1830FIX	Voltage limiter fix for bug 1830	–	0
NGCON	Number of gate contacts	–	1
RGATEMOD	Gate resistance model selector	–	0
XGL	Offset of the gate length due to variations in patterning	m	0
XGW	Distance from the gate contact to the channel edge	m	0
XRCRG1	Parameter for distributed channel resistance effect for intrinsic input resistance	–	12
XRCRG2	Parameter to account for the excess channel diffusion resistance for intrinsic input resistance	–	1
<i>Temperature Parameters</i>			
AT	Temperature coefficient for saturation velocity	m/s	33000
CTH0	Thermal capacitance per unit width	F/m	1e-05
KT1	Temperature coefficient for threshold voltage	V	-0.11
KT1L	Channel length dependence of the temperature coefficient for the threshold voltage	Vm	0
KT2	Body-bias coefficient for the threshold voltage temperature effect	–	0.022
NTRECF	Temperature coefficient for NRECF	–	0
NTRECR	Temperature coefficient for NRECR	–	0
PRT	Temperature coefficient for RDSW	$\Omega \mu\text{m}$	0
RTH0	Thermal resistance per unit width	Ω/m	0
TCJSWG	Temperature coefficient of Cjswg	K ⁻¹	0
TNOM	Nominal device temperature	°C	Ambient Temperature
TPBSWG	Temperature coefficient of Pbswg	V/K	0
UA1	Temperature coefficient for UA	m/V	4.31e-09
UB1	Temperature coefficient for UB	m ² /V ²	-7.61e-18
UC1	Temperature coefficient for UC	m/(°CV ²)	0
UTE	Mobility temperature exponent	–	-1.5
WTH0	Minimum width for thermal resistance calculation	m	0
XBJT	Power dependence of JBJT on temperature	–	1

Table 2-103. BSIM3 SOI Device Model Parameters

Parameter	Description	Units	Default
XDIF	Power dependence of JDIF on temperature	–	0
XREC	Power dependence of JREC on temperature	–	1
XTUN	Power dependence of JTUN on temperature	–	0
<i>Tunnelling Parameters</i>			
ALPHAGB1	First Vox dependent parameter for gate current in inversion	V ⁻¹	0.35
ALPHAGB2	First Vox dependent parameter for gate current in accumulation	V ⁻¹	0.43
BETAGB1	Second Vox dependent parameter for gate current in inversion	V ⁻²	0.03
BETAGB2	First Vox dependent parameter for gate current in accumulation	V ⁻²	0.05
EBG	Effective bandgap in gate current calculation	V	1.2
IGMOD	Gate current model selector	–	0
NTOX	Power term of gate current	–	1
TOXQM	Oxide thickness for Igb calculation	m	0
TOXREF	Target oxide thickness	m	2.5e-09
VECB	Vaux parameter for conduction band electron tunneling	–	0.026
VEVB	Vaux parameter for valence band electron tunneling	–	0.075
VGB1	Third Vox dependent parameter for gate current in inversion	V	300
VGB2	Third Vox dependent parameter for gate current in accumulation	V	17
<i>Built-in Potential Lowering Parameters</i>			
DK2B	Third backgate body effect parameter for short channel effect	–	0
DVBD0	First short channel effect parameter in FD module	–	0
DVBD1	Second short channel effect parameter in FD module	–	0
K1B	First backgate body effect parameter	–	1
K2B	Second backgate body effect parameter for short channel effect	–	0
MOINFD	Gate bias dependance coefficient of surface potential in FD module	–	1000
NOFFFD	Smoothing parameter in FD module	–	1
SOIMOD	SIO model selector,SOIMOD=0: BSIMPD,SOIMOD=1: undefined model for PD and FE,SOIMOD=2: ideal FD	–	0
VBSA	Offset voltage due to non-idealities	V	0

Table 2-103. BSIM3 SOI Device Model Parameters

Parameter	Description	Units	Default
VOFFFD	Smoothing parameter in FD module	V	0

2.3.20.7. Level 14/54 MOSFET Tables (BSIM4)

The level 14 MOSFET device in Xyce is based on the Berkeley BSIM4 model version 4.6.1. (For HSPICE compatibility, the Xyce BSIM4 model can also be specified as level 54.) The model's parameters are given in the following tables. Note that the parameters have not all been properly categorized with units in place. For complete documentation of the BSIM4 model, see the BSIM4 User's Manual, available for download at <http://bsim.berkeley.edu/models/bsim4/>.

Note that the BSIM4 device in Xyce now supports multiple versions selectable with the `VERSION` parameter in the model card. At this time versions 4.6.1, 4.7.0, and 4.8.2 are supported. This version parameter may be specified either in legacy text format ("4.6.1" or "4.8.2") or in the CMC standard floating point format ("4.61" or "4.82").

If a `VERSION` parameter is not given, the latest version supported is used.

If a `VERSION` parameter is given that is not one of the supported version numbers, the closest matching supported version is used instead and a warning given. If a version older than the lowest supported version is chosen, the lowest supported version (4.6.1) is used and a warning given. If a model lower than version 4.7.0 is requested, version 4.6.1 is used (and a warning given). If a version newer than 4.7.0 but older than 4.8.0 is requested, 4.7.0 is used and a warning given. If a version 4.8.0 or later is requested, 4.8.2 is used with an appropriate warning.

Specifying any model parameter that is not supported in the chosen version results in a warning and the parameter being ignored. Parameters that are only valid for specific ranges of versions are noted as such in the tables 2-104 and 2-105.

At this time, the BSIM4 is the only device in Xyce that supports multiple versions in this manner. All other devices that have multiple version in Xyce are handled by having a unique level number for each version.

NOTE: Many BSIM4 parameters listed in tables 2-104 and 2-105 as having default values of zero are actually replaced with internally computed defaults if not given. Specifying zero in your model card will override this internal computation. It is recommended that you only set model parameters that you are actually changing from defaults and that you not generate model cards containing default values from the tables.

Furthermore, the value of `FGIDL` changed from 0 to 1 with version 4.8.2 of the BSIM4. This change is NOT reflected in the table, which is generated automatically, and which shows only the default value of this parameter that applies to versions 4.6.1 and 4.7.0.

Table 2-104. BSIM4 Device Instance Parameters

Parameter	Description	Units	Default
AD	Drain area	–	0
AS	Source area	–	0
IC2		–	0
IC3		–	0
L	Length	–	5e-06
M	Number of parallel copies	–	1
MIN	Minimize either D or S	–	0

Table 2-104. BSIM4 Device Instance Parameters

Parameter	Description	Units	Default
NF	Number of fingers	–	1
NGCON	Number of gate contacts	–	0
OFF	Device is initially off	–	false
PD	Drain perimeter	–	0
PS	Source perimeter	–	0
RBDB	Body resistance	–	0
RBPB	Body resistance	–	0
RBPD	Body resistance	–	0
RBPS	Body resistance	–	0
RBSB	Body resistance	–	0
SA	distance between OD edge to poly of one side	–	0
SB	distance between OD edge to poly of the other side	–	0
SC	Distance to a single well edge	–	0
SCA	Integral of the first distribution function for scattered well dopant	–	0
SCB	Integral of the second distribution function for scattered well dopant	–	0
SCC	Integral of the third distribution function for scattered well dopant	–	0
SD	distance between neighbour fingers	–	0
W	Width	–	5e-06
XGW	Distance from gate contact center to device edge	–	0
<i>Basic Parameters</i>			
DELVT0	Zero bias threshold voltage variation	V	0
DELVTO	Zero bias threshold voltage variation	V	0
<i>Control Parameters</i>			
ACNQSMOD	AC NQS model selector	–	0
GEOMOD	Geometry dependent parasitics model selector	–	0
RBODYMOD	Distributed body R model selector	–	0
RGATEMOD	Gate resistance model selector	–	0
RGEOMOD	S/D resistance and contact model selector	–	0
TRNQSMOD	Transient NQS model selector	–	0
<i>Temperature Parameters</i>			
DTEMP	Device delta temperature	°C	0
TEMP	Device temperature	°C	Ambient Temperature

Voltage Parameters

Table 2-104. BSIM4 Device Instance Parameters

Parameter	Description	Units	Default
IC1	Vector of initial values: Vds,Vgs,Vbs	V	0
<i>Asymmetric and Bias-Dependent R_{ds} Parameters</i>			
NRD	Number of squares in drain	–	1
NRS	Number of squares in source	–	1

Table 2-105. BSIM4 Device Model Parameters

Parameter	Description	Units	Default
AF	Flicker noise exponent	–	1
AIGSD	Parameter for Igs,d	–	0.0136
AT	Temperature coefficient of vsat	–	33000
BIGSD	Parameter for Igs,d	–	0.00171
BVD	Drain diode breakdown voltage	–	10
BVS	Source diode breakdown voltage	–	10
CIGSD	Parameter for Igs,d	–	0.075
CJD	Drain bottom junction capacitance per unit area	–	0.0005
CJS	Source bottom junction capacitance per unit area	–	0.0005
CJSWD	Drain sidewall junction capacitance per unit periphery	–	5e-10
CJSWGD	Drain (gate side) sidewall junction capacitance per unit width	–	0
CJSWGS	Source (gate side) sidewall junction capacitance per unit width	–	0
CJSWS	Source sidewall junction capacitance per unit periphery	–	5e-10
DLCIG	Delta L for Ig model	–	0
DMCG	Distance of Mid-Contact to Gate edge	–	0
DMCGT	Distance of Mid-Contact to Gate edge in Test structures	–	0
DMCI	Distance of Mid-Contact to Isolation	–	0
DMDG	Distance of Mid-Diffusion to Gate edge	–	0
DWJ	Delta W for S/D junctions	–	0
EF	Flicker noise frequency exponent	–	1
EM	Flicker noise parameter	–	4.1e+07
EPSRGATE	Dielectric constant of gate relative to vacuum	–	11.7
GBMIN	Minimum body conductance	Ω^{-1}	1e-12
GIDLCLAMP [Only for versions starting with 4.82]	gidl clamp value	–	-1e-05

Table 2-105. BSIM4 Device Model Parameters

Parameter	Description	Units	Default
IDOVVDS [Only for versions starting with 4.82]	noise clamping limit parameter	–	1e-09
IJTHDFWD	Forward drain diode forward limiting current	–	0.1
IJTHDREV	Reverse drain diode forward limiting current	–	0.1
IJTHSFWD	Forward source diode forward limiting current	–	0.1
IJTHSREV	Reverse source diode forward limiting current	–	0.1
JSD	Bottom drain junction reverse saturation current density	–	0.0001
JSS	Bottom source junction reverse saturation current density	–	0.0001
JSWD	Isolation edge sidewall drain junction reverse saturation current density	–	0
JSWGD	Gate edge drain junction reverse saturation current density	–	0
JSWGS	Gate edge source junction reverse saturation current density	–	0
JSWS	Isolation edge sidewall source junction reverse saturation current density	–	0
JTSD	Drain bottom trap-assisted saturation current density	–	0
JTSS	Source bottom trap-assisted saturation current density	–	0
JTSSWD	Drain STI sidewall trap-assisted saturation current density	–	0
JTSSWGD	Drain gate-edge sidewall trap-assisted saturation current density	–	0
JTSSWGS	Source gate-edge sidewall trap-assisted saturation current density	–	0
JTSSWS	Source STI sidewall trap-assisted saturation current density	–	0
JTWEFF [Only for versions starting with 4.7]	TAT current width dependence	m	0
K2WE	K2 shift factor for well proximity effect	–	0
K3B	Body effect coefficient of k3	–	0
KF	Flicker noise coefficient	–	0
KT1	Temperature coefficient of Vth	–	-0.11
KT1L	Temperature coefficient of Vth	–	0
KT2	Body-coefficient of kt1	–	0.022
KU0	Mobility degradation/enhancement coefficient for LOD	–	0
KU0WE	Mobility degradation factor for well proximity effect	–	0

Table 2-105. BSIM4 Device Model Parameters

Parameter	Description	Units	Default
KVSAT	Saturation velocity degradation/enhancement parameter for LOD	–	0
KVTH0	Threshold degradation/enhancement parameter for LOD	–	0
KVTH0WE	Threshold shift factor for well proximity effect	–	0
LA0	Length dependence of a0	–	0
LA1	Length dependence of a1	–	0
LA2	Length dependence of a2	–	0
LACDE	Length dependence of acde	–	0
LAGIDL	Length dependence of agidl	–	0
LAGISL	Length dependence of agisl	–	0
LAGS	Length dependence of ags	–	0
LAIGBACC	Length dependence of aigbacc	–	0
LAIGBINV	Length dependence of aigbinv	–	0
LAIGC	Length dependence of aigc	–	0
LAIGD	Length dependence of aigd	–	0
LAIGS	Length dependence of aigs	–	0
LAIGSD	Length dependence of aigsd	–	0
LALPHA0	Length dependence of alpha0	–	0
LALPHA1	Length dependence of alpha1	–	0
LAT	Length dependence of at	–	0
LB0	Length dependence of b0	–	0
LB1	Length dependence of b1	–	0
LBETA0	Length dependence of beta0	–	0
LBGIDL	Length dependence of bgidl	–	0
LBGISL	Length dependence of bgisl	–	0
LBIGBACC	Length dependence of bigbacc	–	0
LBIGBINV	Length dependence of bigbinv	–	0
LBIGC	Length dependence of bigc	–	0
LBIGD	Length dependence of bigd	–	0
LBIGS	Length dependence of bigs	–	0
LBIGSD	Length dependence of bigsd	–	0
LCDSC	Length dependence of cdsc	–	0
LCDSCB	Length dependence of cdsb	–	0
LCDSCD	Length dependence of cdsd	–	0
LCF	Length dependence of cf	–	0

Table 2-105. BSIM4 Device Model Parameters

Parameter	Description	Units	Default
LCGDL	Length dependence of cgdI	–	0
LCGIDL	Length dependence of cgidI	–	0
LCGISL	Length dependence of cgisI	–	0
LCGSL	Length dependence of cgsl	–	0
LCIGBACC	Length dependence of cigbacc	–	0
LCIGBINV	Length dependence of cigbinv	–	0
LCIGC	Length dependence of cigc	–	0
LCIGD	Length dependence of cigd	–	0
LCIGS	Length dependence of cigs	–	0
LCIGSD	Length dependence of cigsd	–	0
LCIT	Length dependence of cit	–	0
LCKAPPAD	Length dependence of ckappad	–	0
LCKAPPAS	Length dependence of ckappas	–	0
LCLC	Length dependence of clc	–	0
LCLE	Length dependence of cle	–	0
LDELTA	Length dependence of delta	–	0
LDROUT	Length dependence of drout	–	0
LDSUB	Length dependence of dsub	–	0
LDVT0	Length dependence of dvt0	–	0
LDVT0W	Length dependence of dvt0w	–	0
LDVT1	Length dependence of dvt1	–	0
LDVT1W	Length dependence of dvt1w	–	0
LDVT2	Length dependence of dvt2	–	0
LDVT2W	Length dependence of dvt2w	–	0
LDVTP0	Length dependence of dvtp0	–	0
LDVTP1	Length dependence of dvtp1	–	0
LDVTP2 [Only for versions starting with 4.7]	Length dependence of dvtp2	–	0
LDVTP3 [Only for versions starting with 4.7]	Length dependence of dvtp3	–	0
LDVTP4 [Only for versions starting with 4.7]	Length dependence of dvtp4	–	0
LDVTP5 [Only for versions starting with 4.7]	Length dependence of dvtp5	–	0
LDWB	Length dependence of dwb	–	0
LDWG	Length dependence of dwg	–	0
LEGIDL	Length dependence of egidI	–	0

Table 2-105. BSIM4 Device Model Parameters

Parameter	Description	Units	Default
LEGISL	Length dependence of egisl	–	0
LEIGBINV	Length dependence for eigbinv	–	0
LETA0	Length dependence of eta0	–	0
LETAB	Length dependence of etab	–	0
LEU	Length dependence of eu	–	0
LFGIDL [Only for versions starting with 4.7]	Length dependence of fgidl	–	0
LFGISL [Only for versions starting with 4.7]	Length dependence of fgisl	–	0
LFPROUT	Length dependence of pdiblcb	–	0
LGAMMA1	Length dependence of gamma1	–	0
LGAMMA2	Length dependence of gamma2	–	0
LINTNOI	lint offset for noise calculation	–	0
LK1	Length dependence of k1	–	0
LK2	Length dependence of k2	–	0
LK2WE	Length dependence of k2we	–	0
LK3	Length dependence of k3	–	0
LK3B	Length dependence of k3b	–	0
LKETA	Length dependence of keta	–	0
LKGIDL [Only for versions starting with 4.7]	Length dependence of kgidl	–	0
LKGISL [Only for versions starting with 4.7]	Length dependence of kgisl	–	0
LKT1	Length dependence of kt1	–	0
LKT1L	Length dependence of kt1l	–	0
LKT2	Length dependence of kt2	–	0
LKU0	Length dependence of ku0	–	0
LKU0WE	Length dependence of ku0we	–	0
LKVTH0	Length dependence of kvth0	–	0
LKVTH0WE	Length dependence of kvth0we	–	0
LL	Length reduction parameter	–	0
LLAMBDA	Length dependence of lambda	–	0
LLC	Length reduction parameter for CV	–	0
LLN	Length reduction parameter	–	1
LLODKU0	Length parameter for u0 LOD effect	–	0
LLODVTH	Length parameter for vth LOD effect	–	0
LLP	Length dependence of lp	–	0

Table 2-105. BSIM4 Device Model Parameters

Parameter	Description	Units	Default
LLPE0	Length dependence of lpe0	–	0
LLPEB	Length dependence of lpeb	–	0
LMAX	Maximum length for the model	–	1
LMIN	Minimum length for the model	–	0
LMINV	Length dependence of minv	–	0
LMINVCV	Length dependence of minvcv	–	0
LMOIN	Length dependence of moin	–	0
LNDEP	Length dependence of ndep	–	0
LNFACTOR	Length dependence of nfactor	–	0
LNGATE	Length dependence of ngate	–	0
LNIGBACC	Length dependence of nigbacc	–	0
LNIGBINV	Length dependence of nigbinv	–	0
LNIGC	Length dependence of nigc	–	0
LNOFF	Length dependence of noff	–	0
LNSD	Length dependence of nsd	–	0
LNSUB	Length dependence of nsub	–	0
LNTOX	Length dependence of ntox	–	0
LODETA0	eta0 shift modification factor for stress effect	–	1
LODK2	K2 shift modification factor for stress effect	–	1
LPCLM	Length dependence of pclm	–	0
LPDIBLC1	Length dependence of pdiblc1	–	0
LPDIBLC2	Length dependence of pdiblc2	–	0
LPDIBLCB	Length dependence of pdiblcb	–	0
LPDITS	Length dependence of pdits	–	0
LPDITSD	Length dependence of pditsd	–	0
LPHIN	Length dependence of phin	–	0
LPIGCD	Length dependence for pigcd	–	0
LPOXEDGE	Length dependence for poxedge	–	0
LPRT	Length dependence of prt	–	0
LPRWB	Length dependence of prwb	–	0
LPRWG	Length dependence of prwg	–	0
LPSCBE1	Length dependence of pscbe1	–	0
LPSCBE2	Length dependence of pscbe2	–	0
LPVAG	Length dependence of pvag	–	0
LRDSW	Length dependence of rdsw	–	0
LRDW	Length dependence of rdw	–	0

Table 2-105. BSIM4 Device Model Parameters

Parameter	Description	Units	Default
LRGIDL [Only for versions starting with 4.7]	Length dependence of rgidl	–	0
LRGISL [Only for versions starting with 4.7]	Length dependence of rgisl	–	0
LRSW	Length dependence of rsw	–	0
LTETA0 [Only for versions starting with 4.7]	Length dependence of teta0	–	0
LTNFACTOR [Only for versions starting with 4.7]	Length dependence of tnfactor	–	0
LTVFBSDOFF	Length dependence of tvfbsdoff	–	0
LTVOFF	Length dependence of tvoff	–	0
LTVOFFCV [Only for versions starting with 4.7]	Length dependence of tvoffcv	–	0
LU0	Length dependence of u0	–	0
LUA	Length dependence of ua	–	0
LUA1	Length dependence of ua1	–	0
LUB	Length dependence of ub	–	0
LUB1	Length dependence of ub1	–	0
LUC	Length dependence of uc	–	0
LUC1	Length dependence of uc1	–	0
LUCS [Only for versions starting with 4.7]	Length dependence of ucs	–	0
LUCSTE [Only for versions starting with 4.7]	Length dependence of ucste	–	0
LUD	Length dependence of ud	–	0
LUD1	Length dependence of ud1	–	0
LUP	Length dependence of up	–	0
LUTE	Length dependence of ute	–	0
LVBM	Length dependence of vbm	–	0
LVBX	Length dependence of vbx	–	0
LVFB	Length dependence of vfb	–	0
LVFBCV	Length dependence of vfbcv	–	0
LVFBSDOFF	Length dependence of vfbstdoff	–	0
LVOFF	Length dependence of voff	–	0
LVOFFCV	Length dependence of voffcv	–	0
LVSAT	Length dependence of vsat	–	0
LVTH0		–	0
LVTL	Length dependence of vtl	–	0

Table 2-105. BSIM4 Device Model Parameters

Parameter	Description	Units	Default
LW	Length reduction parameter	–	0
LW0	Length dependence of w0	–	0
LWC	Length reduction parameter for CV	–	0
LWL	Length reduction parameter	–	0
LWLC	Length reduction parameter for CV	–	0
LWN	Length reduction parameter	–	1
LWR	Length dependence of wr	–	0
LXJ	Length dependence of xj	–	0
LXN	Length dependence of xn	–	0
LXRCRG1	Length dependence of xrcrg1	–	0
LXRCRG2	Length dependence of xrcrg2	–	0
LXT	Length dependence of xt	–	0
MJD	Drain bottom junction capacitance grading coefficient	–	0.5
MJS	Source bottom junction capacitance grading coefficient	–	0.5
MJSWD	Drain sidewall junction capacitance grading coefficient	–	0.33
MJSWGD	Drain (gate side) sidewall junction capacitance grading coefficient	–	0.33
MJSWGS	Source (gate side) sidewall junction capacitance grading coefficient	–	0.33
MJSWS	Source sidewall junction capacitance grading coefficient	–	0.33
NGCON	Number of gate contacts	–	1
NJD	Drain junction emission coefficient	–	1
NJS	Source junction emission coefficient	–	1
NJTS	Non-ideality factor for bottom junction	–	20
NJTSD	Non-ideality factor for bottom junction drain side	–	20
NJTSSW	Non-ideality factor for STI sidewall junction	–	20
NJTSSWD	Non-ideality factor for STI sidewall junction drain side	–	20
NJTSSWG	Non-ideality factor for gate-edge sidewall junction	–	20
NJTSSWGD	Non-ideality factor for gate-edge sidewall junction drain side	–	20
NTNOI	Thermal noise parameter	–	1
PA0	Cross-term dependence of a0	–	0
PA1	Cross-term dependence of a1	–	0
PA2	Cross-term dependence of a2	–	0
PACDE	Cross-term dependence of acde	–	0

Table 2-105. BSIM4 Device Model Parameters

Parameter	Description	Units	Default
PAGIDL	Cross-term dependence of agidl	–	0
PAGISL	Cross-term dependence of agisl	–	0
PAGS	Cross-term dependence of ags	–	0
PAIGBACC	Cross-term dependence of aigbacc	–	0
PAIGBINV	Cross-term dependence of aigbinv	–	0
PAIGC	Cross-term dependence of aigc	–	0
PAIGD	Cross-term dependence of aigd	–	0
PAIGS	Cross-term dependence of aigs	–	0
PAIGSD	Cross-term dependence of aigsd	–	0
PALPHA0	Cross-term dependence of alpha0	–	0
PALPHA1	Cross-term dependence of alpha1	–	0
PAT	Cross-term dependence of at	–	0
PB0	Cross-term dependence of b0	–	0
PB1	Cross-term dependence of b1	–	0
PBD	Drain junction built-in potential	–	1
PBETA0	Cross-term dependence of beta0	–	0
PBGIDL	Cross-term dependence of bgidl	–	0
PBGISL	Cross-term dependence of bgisl	–	0
PBIGBACC	Cross-term dependence of bigbacc	–	0
PBIGBINV	Cross-term dependence of bigbinv	–	0
PBIGC	Cross-term dependence of bigc	–	0
PBIGD	Cross-term dependence of bigd	–	0
PBIGS	Cross-term dependence of bigs	–	0
PBIGSD	Cross-term dependence of bigsd	–	0
PBS	Source junction built-in potential	–	1
PBSWD	Drain sidewall junction capacitance built in potential	–	1
PBSWGD	Drain (gate side) sidewall junction capacitance built in potential	–	0
PBSWGS	Source (gate side) sidewall junction capacitance built in potential	–	0
PBSWS	Source sidewall junction capacitance built in potential	–	1
PCDSC	Cross-term dependence of cdsc	–	0
PCDSCB	Cross-term dependence of cdsccb	–	0
PCDSCD	Cross-term dependence of cdsccd	–	0
PCF	Cross-term dependence of cf	–	0
PCGDL	Cross-term dependence of cgdl	–	0

Table 2-105. BSIM4 Device Model Parameters

Parameter	Description	Units	Default
PCGIDL	Cross-term dependence of cgidl	–	0
PCGISL	Cross-term dependence of cgisl	–	0
PCGSL	Cross-term dependence of cgsl	–	0
PCIGBACC	Cross-term dependence of cigbacc	–	0
PCIGBINV	Cross-term dependence of cigbinv	–	0
PCIGC	Cross-term dependence of cigc	–	0
PCIGD	Cross-term dependence of cigd	–	0
PCIGS	Cross-term dependence of cigs	–	0
PCIGSD	Cross-term dependence of cigsd	–	0
PCIT	Cross-term dependence of cit	–	0
PCKAPPAD	Cross-term dependence of ckappad	–	0
PCKAPPAS	Cross-term dependence of ckappas	–	0
PCLC	Cross-term dependence of clc	–	0
PCLC	Cross-term dependence of cle	–	0
PDELTA	Cross-term dependence of delta	–	0
PDROUT	Cross-term dependence of drouT	–	0
PDSUB	Cross-term dependence of dsub	–	0
PDVT0	Cross-term dependence of dvt0	–	0
PDVT0W	Cross-term dependence of dvt0w	–	0
PDVT1	Cross-term dependence of dvt1	–	0
PDVT1W	Cross-term dependence of dvt1w	–	0
PDVT2	Cross-term dependence of dvt2	–	0
PDVT2W	Cross-term dependence of dvt2w	–	0
PDVTP0	Cross-term dependence of dvtp0	–	0
PDVTP1	Cross-term dependence of dvtp1	–	0
PDVTP2 [Only for versions starting with 4.7]	Cross-term dependence of dvtp2	–	0
PDVTP3 [Only for versions starting with 4.7]	Cross-term dependence of dvtp3	–	0
PDVTP4 [Only for versions starting with 4.7]	Cross-term dependence of dvtp4	–	0
PDVTP5 [Only for versions starting with 4.7]	Cross-term dependence of dvtp5	–	0
PDWB	Cross-term dependence of dwb	–	0
PDWG	Cross-term dependence of dwg	–	0
PEGIDL	Cross-term dependence of egidl	–	0
PEGISL	Cross-term dependence of egisl	–	0

Table 2-105. BSIM4 Device Model Parameters

Parameter	Description	Units	Default
PEIGBINV	Cross-term dependence for eigbinv	–	0
PETA0	Cross-term dependence of eta0	–	0
PETAB	Cross-term dependence of etab	–	0
PEU	Cross-term dependence of eu	–	0
PFGIDL [Only for versions starting with 4.7]	Cross-term dependence of fgidl	–	0
PFGISL [Only for versions starting with 4.7]	Cross-term dependence of fgisl	–	0
PFPROUT	Cross-term dependence of pdiblcb	–	0
PGAMMA1	Cross-term dependence of gamma1	–	0
PGAMMA2	Cross-term dependence of gamma2	–	0
PHIG	Work Function of gate	–	4.05
PK1	Cross-term dependence of k1	–	0
PK2	Cross-term dependence of k2	–	0
PK2WE	Cross-term dependence of k2we	–	0
PK3	Cross-term dependence of k3	–	0
PK3B	Cross-term dependence of k3b	–	0
PKETA	Cross-term dependence of keta	–	0
PKGIDL [Only for versions starting with 4.7]	Cross-term dependence of kgidl	–	0
PKGISL [Only for versions starting with 4.7]	Cross-term dependence of kgisl	–	0
PKT1	Cross-term dependence of kt1	–	0
PKT1L	Cross-term dependence of kt1l	–	0
PKT2	Cross-term dependence of kt2	–	0
PKU0	Cross-term dependence of ku0	–	0
PKU0WE	Cross-term dependence of ku0we	–	0
PKVTH0	Cross-term dependence of kvth0	–	0
PKVTH0WE	Cross-term dependence of kvth0we	–	0
PLAMBDA	Cross-term dependence of lambda	–	0
PLP	Cross-term dependence of lp	–	0
PLPE0	Cross-term dependence of lpe0	–	0
PLPEB	Cross-term dependence of lpeb	–	0
PMINV	Cross-term dependence of minv	–	0
PMINVCV	Cross-term dependence of minvcv	–	0
PMOIN	Cross-term dependence of moin	–	0
PNDEP	Cross-term dependence of ndep	–	0

Table 2-105. BSIM4 Device Model Parameters

Parameter	Description	Units	Default
PNFACTOR	Cross-term dependence of nfactor	–	0
PNGATE	Cross-term dependence of ngate	–	0
PNIGBACC	Cross-term dependence of nighbacc	–	0
PNIGBINV	Cross-term dependence of nigbinv	–	0
PNIGC	Cross-term dependence of nigc	–	0
PNOFF	Cross-term dependence of noff	–	0
PNSD	Cross-term dependence of nsd	–	0
PNSUB	Cross-term dependence of nsub	–	0
PNTOX	Cross-term dependence of ntox	–	0
PPCLM	Cross-term dependence of pclm	–	0
PPDIBLC1	Cross-term dependence of pdiblc1	–	0
PPDIBLC2	Cross-term dependence of pdiblc2	–	0
PPDIBLCB	Cross-term dependence of pdiblcb	–	0
PPDITS	Cross-term dependence of pdits	–	0
PPDITSD	Cross-term dependence of pditsd	–	0
PPHIN	Cross-term dependence of phin	–	0
PPIGCD	Cross-term dependence for pigcd	–	0
PPOXEDGE	Cross-term dependence for poxedge	–	0
PPRT	Cross-term dependence of prt	–	0
PPRWB	Cross-term dependence of prwb	–	0
PPRWG	Cross-term dependence of prwg	–	0
PPSCBE1	Cross-term dependence of pscbe1	–	0
PPSCBE2	Cross-term dependence of pscbe2	–	0
PPVAG	Cross-term dependence of pvag	–	0
PRDSW	Cross-term dependence of rdsw	–	0
PRDW	Cross-term dependence of rdw	–	0
PRGIDL [Only for versions starting with 4.7]	Cross-term dependence of rgidl	–	0
PRGISL [Only for versions starting with 4.7]	Cross-term dependence of rgisl	–	0
PRSW	Cross-term dependence of rsw	–	0
PRT	Temperature coefficient of parasitic resistance	–	0
PTETA0 [Only for versions starting with 4.7]	Cross-term dependence of teta0	–	0
PTNFACTOR [Only for versions starting with 4.7]	Cross-term dependence of tnfactor	–	0
PTVFBSDOFF	Cross-term dependence of tvfbsdoff	–	0

Table 2-105. BSIM4 Device Model Parameters

Parameter	Description	Units	Default
PTVOFF	Cross-term dependence of tvoff	–	0
PTVOFFCV [Only for versions starting with 4.7]	Cross-term dependence of tvoffcv	–	0
PU0	Cross-term dependence of u0	–	0
PUA	Cross-term dependence of ua	–	0
PUA1	Cross-term dependence of ua1	–	0
PUB	Cross-term dependence of ub	–	0
PUB1	Cross-term dependence of ub1	–	0
PUC	Cross-term dependence of uc	–	0
PUC1	Cross-term dependence of uc1	–	0
PUCS [Only for versions starting with 4.7]	Cross-term dependence of ucs	–	0
PUCSTE [Only for versions starting with 4.7]	Cross-term dependence of ucste	–	0
PUD	Cross-term dependence of ud	–	0
PUD1	Cross-term dependence of ud1	–	0
PUP	Cross-term dependence of up	–	0
PUTE	Cross-term dependence of ute	–	0
PVAG	Gate dependence of output resistance parameter	–	0
PVBM	Cross-term dependence of vbm	–	0
PVBX	Cross-term dependence of vbx	–	0
PVFB	Cross-term dependence of vfb	–	0
PVFBCV	Cross-term dependence of vfbcv	–	0
PVBSDOFF	Cross-term dependence of vfbsdoff	–	0
PVOFF	Cross-term dependence of voff	–	0
PVOFFCV	Cross-term dependence of voffcv	–	0
PVSAT	Cross-term dependence of vsat	–	0
PVTH0		–	0
PVTL	Cross-term dependence of vtl	–	0
PW0	Cross-term dependence of w0	–	0
PWR	Cross-term dependence of wr	–	0
PXJ	Cross-term dependence of xj	–	0
PXN	Cross-term dependence of xn	–	0
PXRCRG1	Cross-term dependence of xrcrg1	–	0
PXRCRG2	Cross-term dependence of xrcrg2	–	0
PXT	Cross-term dependence of xt	–	0
RBDB	Resistance between bNode and dbNode	Ω	50

Table 2-105. BSIM4 Device Model Parameters

Parameter	Description	Units	Default
RBDBX0	Body resistance RBDBX scaling	–	100
RBDBY0	Body resistance RBDBY scaling	–	100
RBPB	Resistance between bNodePrime and bNode	Ω	50
RBPBX0	Body resistance RBPBX scaling	–	100
RBPBXL	Body resistance RBPBX L scaling	–	0
RBPBXNF	Body resistance RBPBX NF scaling	–	0
RBPBXW	Body resistance RBPBX W scaling	–	0
RBPBY0	Body resistance RBPBY scaling	–	100
RBPBYL	Body resistance RBPBY L scaling	–	0
RBPBYNF	Body resistance RBPBY NF scaling	–	0
RBPBYW	Body resistance RBPBY W scaling	–	0
RBPD	Resistance between bNodePrime and bNode	Ω	50
RBPD0	Body resistance RBPD scaling	–	50
RBPDL	Body resistance RBPD L scaling	–	0
RPDINF	Body resistance RBPD NF scaling	–	0
RPDWF	Body resistance RBPD W scaling	–	0
RBPS	Resistance between bNodePrime and sbNode	Ω	50
RBPS0	Body resistance RBPS scaling	–	50
RBPSL	Body resistance RBPS L scaling	–	0
RBPSNF	Body resistance RBPS NF scaling	–	0
RBPSW	Body resistance RBPS W scaling	–	0
RBSB	Resistance between bNode and sbNode	Ω	50
RBSBX0	Body resistance RBSBX scaling	–	100
RBSBY0	Body resistance RBSBY scaling	–	100
RBSDBXL	Body resistance RBSDBX L scaling	–	0
RBSDBXNF	Body resistance RBSDBX NF scaling	–	0
RBSDBXW	Body resistance RBSDBX W scaling	–	0
RBSDBYL	Body resistance RBSDBY L scaling	–	0
RBSDBYNF	Body resistance RBSDBY NF scaling	–	0
RBSDBYW	Body resistance RBSDBY W scaling	–	0
RNOIA	Thermal noise coefficient	–	0.577
RNOIB	Thermal noise coefficient	–	0.5164
RNOIC [Only for versions starting with 4.7]	Thermal noise coefficient	–	0.395
SAREF	Reference distance between OD edge to poly of one side	–	1e-06

Table 2-105. BSIM4 Device Model Parameters

Parameter	Description	Units	Default
SBREF	Reference distance between OD edge to poly of the other side	–	1e-06
SCREF	Reference distance to calculate SCA,SCB and SCC	–	1e-06
STETA0	eta0 shift factor related to stress effect on vth	–	0
STK2	K2 shift factor related to stress effect on vth	–	0
TCJ	Temperature coefficient of cj	–	0
TCJSW	Temperature coefficient of cjsw	–	0
TCJSWG	Temperature coefficient of cjswg	–	0
TETA0 [Only for versions starting with 4.7]	Temperature parameter for eta0	–	0
TKU0	Temperature coefficient of KU0	–	0
TNFACTOR [Only for versions starting with 4.7]	Temperature parameter for nfactor	–	0
TNJTS	Temperature coefficient for NJTS	–	0
TNJTSD	Temperature coefficient for NJTSD	–	0
TNJTSSW	Temperature coefficient for NJTSSW	–	0
TNJTSSWD	Temperature coefficient for NJTSSWD	–	0
TNJTSSWG	Temperature coefficient for NJTSSWG	–	0
TNJTSSWGD	Temperature coefficient for NJTSSWGD	–	0
TNOIA	Thermal noise parameter	–	1.5
TNOIB	Thermal noise parameter	–	3.5
TNOIC [Only for versions starting with 4.7]	Thermal noise parameter	–	0
TNOM	Parameter measurement temperature	–	Ambient Temperature
TPB	Temperature coefficient of pb	–	0
TPBSW	Temperature coefficient of pbsw	–	0
TPBSWG	Temperature coefficient of pbswg	–	0
TVFBSDOFF	Temperature parameter for vfbsdoff	–	0
TVOFF	Temperature parameter for voff	–	0
TVOFFCV [Only for versions starting with 4.7]	Temperature parameter for tvoffcv	–	0
UA1	Temperature coefficient of ua	–	1e-09
UB1	Temperature coefficient of ub	–	-1e-18
UC1	Temperature coefficient of uc	–	0
UCSTE [Only for versions starting with 4.7]	Temperature coefficient of colombic mobility	–	-0.004775
UD1	Temperature coefficient of ud	–	0

Table 2-105. BSIM4 Device Model Parameters

Parameter	Description	Units	Default
UTE	Temperature coefficient of mobility	–	-1.5
VTSD	Drain bottom trap-assisted voltage dependent parameter	–	10
VTSS	Source bottom trap-assisted voltage dependent parameter	–	10
VTSSWD	Drain STI sidewall trap-assisted voltage dependent parameter	–	10
VTSSWGD	Drain gate-edge sidewall trap-assisted voltage dependent parameter	–	10
VTSSWGS	Source gate-edge sidewall trap-assisted voltage dependent parameter	–	10
VTSSWS	Source STI sidewall trap-assisted voltage dependent parameter	–	10
WA0	Width dependence of a0	–	0
WA1	Width dependence of a1	–	0
WA2	Width dependence of a2	–	0
WACDE	Width dependence of acde	–	0
WAGIDL	Width dependence of agidl	–	0
WAGISL	Width dependence of agisl	–	0
WAGS	Width dependence of ags	–	0
WAIGBACC	Width dependence of aigbacc	–	0
WAIGBINV	Width dependence of aigbinv	–	0
WAIGC	Width dependence of aigc	–	0
WAIGD	Width dependence of aigd	–	0
WAIGS	Width dependence of aigs	–	0
WAIGSD	Width dependence of aigsd	–	0
WALPHA0	Width dependence of alpha0	–	0
WALPHA1	Width dependence of alpha1	–	0
WAT	Width dependence of at	–	0
WB0	Width dependence of b0	–	0
WB1	Width dependence of b1	–	0
WBETA0	Width dependence of beta0	–	0
WBGIDL	Width dependence of bgidl	–	0
WBGISL	Width dependence of bgisl	–	0
WBIGBACC	Width dependence of bigbacc	–	0
WBIGBINV	Width dependence of bigbinv	–	0
WBIGC	Width dependence of bigc	–	0
WBIGD	Width dependence of bigd	–	0

Table 2-105. BSIM4 Device Model Parameters

Parameter	Description	Units	Default
WBIGS	Width dependence of bigs	–	0
WBIGSD	Width dependence of bigsd	–	0
WCDSC	Width dependence of cdsc	–	0
WCDSCB	Width dependence of cdsb	–	0
WCDSCD	Width dependence of cdsd	–	0
WCF	Width dependence of cf	–	0
WCGDL	Width dependence of cgdl	–	0
WCGIDL	Width dependence of cgidl	–	0
WCGISL	Width dependence of cgisl	–	0
WCGSL	Width dependence of cgsl	–	0
WCIGBACC	Width dependence of cigbacc	–	0
WCIGBINV	Width dependence of cigbinv	–	0
WCIGC	Width dependence of cigc	–	0
WCIGD	Width dependence of cigd	–	0
WCIGS	Width dependence of cigs	–	0
WCIGSD	Width dependence of cigsd	–	0
WCIT	Width dependence of cit	–	0
WCKAPPAD	Width dependence of ckappad	–	0
WCKAPPAS	Width dependence of ckappas	–	0
WCLC	Width dependence of clc	–	0
WCLE	Width dependence of cle	–	0
WDELTA	Width dependence of delta	–	0
WDROUT	Width dependence of drout	–	0
WDSUB	Width dependence of dsub	–	0
WDVT0	Width dependence of dvt0	–	0
WDVT0W	Width dependence of dvt0w	–	0
WDVT1	Width dependence of dvt1	–	0
WDVT1W	Width dependence of dvt1w	–	0
WDVT2	Width dependence of dvt2	–	0
WDVT2W	Width dependence of dvt2w	–	0
WDVTP0	Width dependence of dvtp0	–	0
WDVTP1	Width dependence of dvtp1	–	0
WDVTP2 [Only for versions starting with 4.7]	Width dependence of dvtp2	–	0
WDVTP3 [Only for versions starting with 4.7]	Width dependence of dvtp3	–	0

Table 2-105. BSIM4 Device Model Parameters

Parameter	Description	Units	Default
WDVTP4 [Only for versions starting with 4.7]	Width dependence of dvtvp4	–	0
WDVTP5 [Only for versions starting with 4.7]	Width dependence of dvtvp5	–	0
WDWB	Width dependence of dwb	–	0
WDWG	Width dependence of dwg	–	0
WEB	Coefficient for SCB	–	0
WEC	Coefficient for SCC	–	0
WEGIDL	Width dependence of egidl	–	0
WEGISL	Width dependence of egisl	–	0
WEIGBINV	Width dependence for eigbinv	–	0
WETA0	Width dependence of eta0	–	0
WETAB	Width dependence of etab	–	0
WEU	Width dependence of eu	–	0
WFGIDL [Only for versions starting with 4.7]	Width dependence of fgidl	–	0
WFGISL [Only for versions starting with 4.7]	Width dependence of fgisl	–	0
WFPROUT	Width dependence of pdiblcb	–	0
WGAMMA1	Width dependence of gamma1	–	0
WGAMMA2	Width dependence of gamma2	–	0
WK1	Width dependence of k1	–	0
WK2	Width dependence of k2	–	0
WK2WE	Width dependence of k2we	–	0
WK3	Width dependence of k3	–	0
WK3B	Width dependence of k3b	–	0
WKETA	Width dependence of keta	–	0
WKGIDL [Only for versions starting with 4.7]	Width dependence of kgidl	–	0
WKGISL [Only for versions starting with 4.7]	Width dependence of kgisl	–	0
WKT1	Width dependence of kt1	–	0
WKT1L	Width dependence of kt1l	–	0
WKT2	Width dependence of kt2	–	0
WKU0	Width dependence of ku0	–	0
WKU0WE	Width dependence of ku0we	–	0
WKVTH0	Width dependence of kvth0	–	0
WKVTH0WE	Width dependence of kvth0we	–	0

Table 2-105. BSIM4 Device Model Parameters

Parameter	Description	Units	Default
WL	Width reduction parameter	–	0
WLAMBDA	Width dependence of lambda	–	0
WLC	Width reduction parameter for CV	–	0
WLN	Width reduction parameter	–	1
WLOD	Width parameter for stress effect	–	0
WLODKU0	Width parameter for u0 LOD effect	–	0
WLODVTH	Width parameter for vth LOD effect	–	0
WLP	Width dependence of lp	–	0
WLPE0	Width dependence of lpe0	–	0
WLPEB	Width dependence of lpeb	–	0
WMAX	Maximum width for the model	–	1
WMIN	Minimum width for the model	–	0
WMINV	Width dependence of minv	–	0
WMINVCV	Width dependence of minvcv	–	0
WMOIN	Width dependence of moin	–	0
WNDEP	Width dependence of ndep	–	0
WNFACTOR	Width dependence of nfactor	–	0
WNGATE	Width dependence of ngate	–	0
WNIGBACC	Width dependence of nigbacc	–	0
WNIGBINV	Width dependence of nigbinv	–	0
WNIGC	Width dependence of nige	–	0
WNOFF	Width dependence of noff	–	0
WNSD	Width dependence of nsd	–	0
WNSUB	Width dependence of nsub	–	0
WNTOX	Width dependence of ntox	–	0
WPCLM	Width dependence of pclm	–	0
WPDIBLC1	Width dependence of pdiblc1	–	0
WPDIBLC2	Width dependence of pdiblc2	–	0
WPDIBLCB	Width dependence of pdiblc b	–	0
WPDITS	Width dependence of pdits	–	0
WPDITSD	Width dependence of pditsd	–	0
WPEMOD	Flag for WPE model (WPEMOD=1 to activate this model)	–	0
WPHIN	Width dependence of phin	–	0
WPIGCD	Width dependence for pigcd	–	0
WPOXEDGE	Width dependence for poxedge	–	0

Table 2-105. BSIM4 Device Model Parameters

Parameter	Description	Units	Default
WPRT	Width dependence of prt	–	0
WPRWB	Width dependence of prwb	–	0
WPRWG	Width dependence of prwg	–	0
WPSCBE1	Width dependence of pscbe1	–	0
WPSCBE2	Width dependence of pscbe2	–	0
WPVAG	Width dependence of pvag	–	0
WRDSW	Width dependence of rdsw	–	0
WRDW	Width dependence of rdw	–	0
WRGIDL [Only for versions starting with 4.7]	Width dependence of rgidl	–	0
WRGISL [Only for versions starting with 4.7]	Width dependence of rgisl	–	0
WRSW	Width dependence of rsw	–	0
WTETA0 [Only for versions starting with 4.7]	Width dependence of eta0	–	0
WTFACTOR [Only for versions starting with 4.7]	Width dependence of tfactor	–	0
WTVFBSDOFF	Width dependence of tvfbsdoff	–	0
WTVOFF	Width dependence of tvoff	–	0
WTVOFFCV [Only for versions starting with 4.7]	Width dependence of tvoffcv	–	0
WU0	Width dependence of u0	–	0
WUA	Width dependence of ua	–	0
WUA1	Width dependence of ua1	–	0
WUB	Width dependence of ub	–	0
WUB1	Width dependence of ub1	–	0
WUC	Width dependence of uc	–	0
WUC1	Width dependence of uc1	–	0
WUCS [Only for versions starting with 4.7]	Width dependence of ucs	–	0
WUCSTE [Only for versions starting with 4.7]	Width dependence of ucste	–	0
WUD	Width dependence of ud	–	0
WUD1	Width dependence of ud1	–	0
WUP	Width dependence of up	–	0
WUTE	Width dependence of ute	–	0
WVBM	Width dependence of vbm	–	0
WVBX	Width dependence of vbx	–	0

Table 2-105. BSIM4 Device Model Parameters

Parameter	Description	Units	Default
WFBB	Width dependence of vfb	–	0
WFBCV	Width dependence of vfbcv	–	0
WFBSDOFF	Width dependence of vfbsdoff	–	0
WVOFF	Width dependence of voff	–	0
WVOFFCV	Width dependence of voffcv	–	0
WVSAT	Width dependence of vsat	–	0
WVTH0		–	0
WVTL	Width dependence of vtl	–	0
WW	Width reduction parameter	–	0
WW0	Width dependence of w0	–	0
WWC	Width reduction parameter for CV	–	0
WWL	Width reduction parameter	–	0
WWLC	Width reduction parameter for CV	–	0
WWN	Width reduction parameter	–	1
WWR	Width dependence of wr	–	0
WXJ	Width dependence of xj	–	0
WXN	Width dependence of xn	–	0
WXRCRG1	Width dependence of xrcrg1	–	0
WXRCRG2	Width dependence of xrcrg2	–	0
WXT	Width dependence of xt	–	0
XGL	Variation in Ldrawn	–	0
XGW	Distance from gate contact center to device edge	–	0
XJBVD	Fitting parameter for drain diode breakdown current	–	1
XJBVS	Fitting parameter for source diode breakdown current	–	1
XL	L offset for channel length due to mask/etch effect	–	0
XRCRG1	First fitting parameter the bias-dependent Rg	–	12
XRCRG2	Second fitting parameter the bias-dependent Rg	–	1
XTID	Drainjunction current temperature exponent	–	3
XTIS	Source junction current temperature exponent	–	3
XTSD	Power dependence of JTSD on temperature	–	0.02
XTSS	Power dependence of JTSS on temperature	–	0.02
XTSSWD	Power dependence of JTSSWD on temperature	–	0.02
XTSSWGD	Power dependence of JTSSWGD on temperature	–	0.02
XTSSWGS	Power dependence of JTSSWGS on temperature	–	0.02
XTSSWS	Power dependence of JTSSWS on temperature	–	0.02
XW	W offset for channel width due to mask/etch effect	–	0

Table 2-105. BSIM4 Device Model Parameters

Parameter	Description	Units	Default
<i>Basic Parameters</i>			
A0	Non-uniform depletion width effect coefficient.	–	1
A1	Non-saturation effect coefficient	V ⁻¹	0
A2	Non-saturation effect coefficient	–	1
ADOS	Charge centroid parameter	–	1
AGS	Gate bias coefficient of Abulk.	V ⁻¹	0
B0	Abulk narrow width parameter	m	0
B1	Abulk narrow width parameter	m	0
BDOS	Charge centroid parameter	–	1
BG0SUB	Band-gap of substrate at T=0K	eV	1.16
CDSC	Drain/Source and channel coupling capacitance	F/m ²	0.00024
CDSCB	Body-bias dependence of cdsc	F/(Vm ²)	0
CDSCD	Drain-bias dependence of cdsc	F/(Vm ²)	0
CIT	Interface state capacitance	F/m ²	0
DELTA	Effective Vds parameter	V	0.01
DROUT	DIBL coefficient of output resistance	–	0.56
DSUB	DIBL coefficient in the subthreshold region	–	0
DVT0	Short channel effect coeff. 0	–	2.2
DVT0W	Narrow Width coeff. 0	–	0
DVT1	Short channel effect coeff. 1	–	0.53
DVT1W	Narrow Width effect coeff. 1	m ⁻¹	5.3e+06
DVT2	Short channel effect coeff. 2	V ⁻¹	-0.032
DVT2W	Narrow Width effect coeff. 2	V ⁻¹	-0.032
DVTP0	First parameter for Vth shift due to pocket	m	0
DVTP1	Second parameter for Vth shift due to pocket	V ⁻¹	0
DVTP2 [Only for versions starting with 4.7]	3rd parameter for Vth shift due to pocket	Vm ^X	0
DVTP3 [Only for versions starting with 4.7]	4th parameter for Vth shift due to pocket	–	0
DVTP4 [Only for versions starting with 4.7]	5th parameter for Vth shift due to pocket	V ⁻¹	0
DVTP5 [Only for versions starting with 4.7]	6th parameter for Vth shift due to pocket	V	0
DWB	Width reduction parameter	m/V ^{1/2}	0
DWG	Width reduction parameter	m/V	0
EASUB	Electron affinity of substrate	V	4.05
EPSRSUB	Dielectric constant of substrate relative to vacuum	–	11.7

Table 2-105. BSIM4 Device Model Parameters

Parameter	Description	Units	Default
ETA0	Subthreshold region DIBL coefficient	–	0.08
ETAB	Subthreshold region DIBL coefficient	V ⁻¹	-0.07
EU	Mobility exponent	–	0
FPROUT	Rout degradation coefficient for pocket devices	V/m ^{1/2}	0
K1	Bulk effect coefficient 1	V ^{-1/2}	0
K2	Bulk effect coefficient 2	–	0
K3	Narrow width effect coefficient	–	80
KETA	Body-bias coefficient of non-uniform depletion width effect.	V ⁻¹	-0.047
LAMBDA	Velocity overshoot parameter	–	0
LC	back scattering parameter	m	5e-09
LEFFEOT [Only for versions starting with 4.7]	Effective length for extraction of EOT	m	1e-06
LINT	Length reduction parameter	m	0
LP	Channel length exponential factor of mobility	m	1e-08
LPE0	Equivalent length of pocket region at zero bias	m	1.74e-07
LPEB	Equivalent length of pocket region accounting for body bias	m	0
MINV	Fitting parameter for moderate inversion in Vgsteff	–	0
NFACTOR	Subthreshold swing Coefficient	–	1
NI0SUB	Intrinsic carrier concentration of substrate at 300.15K	cm ⁻³	1.45e+10
PCLM	Channel length modulation Coefficient	–	1.3
PDIBLC1	Drain-induced barrier lowering coefficient	–	0.39
PDIBLC2	Drain-induced barrier lowering coefficient	–	0.0086
PDIBLCB	Body-effect on drain-induced barrier lowering	V ⁻¹	0
PDITS	Coefficient for drain-induced Vth shifts	V ⁻¹	0
PDITSD	Vds dependence of drain-induced Vth shifts	V ⁻¹	0
PDITSL	Length dependence of drain-induced Vth shifts	m ⁻¹	0
PHIN	Adjusting parameter for surface potential due to non-uniform vertical doping	V	0
PSCBE1	Substrate current body-effect coefficient	Vm ⁻¹	4.24e+08
PSCBE2	Substrate current body-effect coefficient	m/V	1e-05
TBGASUB	First parameter of band-gap change due to temperature	eV/K	0.000702
TGBSUB	Second parameter of band-gap change due to temperature	K	1108
TEMPEOT [Only for versions starting with 4.7]	Temperature for extraction of EOT	–	300.15
U0	Low-field mobility at Tnom	m ² /(Vs)	0

Table 2-105. BSIM4 Device Model Parameters

Parameter	Description	Units	Default
UA	Linear gate dependence of mobility	m/V	0
UB	Quadratic gate dependence of mobility	m ² /V ²	1e-19
UC	Body-bias dependence of mobility	V ⁻¹	0
UCS [Only for versions starting with 4.7]	Colombic scattering exponent	–	1.67
UD	Coulomb scattering factor of mobility	m ⁻²	0
UP	Channel length linear factor of mobility	m ⁻²	0
VBM	Maximum body voltage	V	-3
VDDEOT	Voltage for extraction of equivalent gate oxide thickness	V	1.5
VFB	Flat Band Voltage	V	-1
VOFF	Threshold voltage offset	V	-0.08
VOFFL	Length dependence parameter for Vth offset	V	0
VSAT	Saturation velocity at tnom	m/s	80000
VTH0		V	0
VTL	thermal velocity	m/s	200000
W0	Narrow width effect parameter	m	2.5e-06
WEFFEOT [Only for versions starting with 4.7]	Effective width for extraction of EOT	m	1e-05
WINT	Width reduction parameter	m	0
XN	back scattering parameter	–	3
<i>Capacitance Parameters</i>			
ACDE	Exponential coefficient for finite charge thickness	m/V	1
CF	Fringe capacitance parameter	F/m	0
CGBO	Gate-bulk overlap capacitance per length	–	0
CGDL	New C-V model parameter	F/m	0
CGDO	Gate-drain overlap capacitance per width	F/m	0
CGSL	New C-V model parameter	F/m	0
CGSO	Gate-source overlap capacitance per width	F/m	0
CKAPPAD	D/G overlap C-V parameter	V	0.6
CKAPPAS	S/G overlap C-V parameter	V	0.6
CLC	Vdsat parameter for C-V model	m	1e-07
CLE	Vdsat parameter for C-V model	–	0.6
DLC	Delta L for C-V model	m	0
DWC	Delta W for C-V model	m	0
MINVCV	Fitting parameter for moderate inversion in Vgsteffcv	–	0
MOIN	Coefficient for gate-bias dependent surface potential	–	15

Table 2-105. BSIM4 Device Model Parameters

Parameter	Description	Units	Default
NOFF	C-V turn-on/off parameter	–	1
VFBCV	Flat Band Voltage parameter for capmod=0 only	V	-1
VOFFCV	C-V lateral-shift parameter	V	0
VOFFCVL	Length dependence parameter for Vth offset in CV	–	0
XPART	Channel charge partitioning	F/m	0
<i>Control Parameters</i>			
ACNQSMOD	AC NQS model selector	–	0
BINUNIT	Bin unit selector	–	1
CAPMOD	Capacitance model selector	–	2
CVCHARGEMOD	Capacitance charge model selector	–	0
DIOMOD	Diode IV model selector	–	1
FNOIMOD	Flicker noise model selector	–	1
GEOMOD	Geometry dependent parasitics model selector	–	0
GIDLMOD [Only for versions starting with 4.7]	parameter for GIDL selector	–	0
IGBMOD	Gate-to-body Ig model selector	–	0
IGCMOD	Gate-to-channel Ig model selector	–	0
MOBMOD	Mobility model selector	–	0
MTRLCOMPATMOD [Only for versions starting with 4.7]	New material Mod backward compatibility selector	–	0
MTRLMOD	parameter for nonm-silicon substrate or metal gate selector	–	0
PARAMCHK	Model parameter checking selector	–	1
PERMOD	Pd and Ps model selector	–	1
RBODYMOD	Distributed body R model selector	–	0
RDSMOD	Bias-dependent S/D resistance model selector	–	0
RGATEMOD	Gate R model selector	–	0
RGEOMOD	S/D resistance and contact model selector	–	0
TEMPMOD	Temperature model selector	–	0
TNOIMOD	Thermal noise model selector	–	0
TRNQSMOD	Transient NQS model selector	–	0
VERSION	parameter for model version	–	'4.8.2'
<i>Flicker and Thermal Noise Parameters</i>			
NOIA	Flicker Noise parameter a	–	0
NOIB	Flicker Noise parameter b	–	0
NOIC	Flicker Noise parameter c	–	0

Process Parameters

Table 2-105. BSIM4 Device Model Parameters

Parameter	Description	Units	Default
DTOX	Defined as (tox _e - tox _p)	m	0
EOT	Equivalent gate oxide thickness in meters	m	1.5e-09
EPSROX	Dielectric constant of the gate oxide relative to vacuum	-	3.9
GAMMA1	V _{th} body coefficient	V ^{1/2}	0
GAMMA2	V _{th} body coefficient	V ^{1/2}	0
NDEP	Channel doping concentration at the depletion edge	cm ⁻³	1.7e+17
NGATE	Poly-gate doping concentration	cm ⁻³	0
NSD	S/D doping concentration	cm ⁻³	1e+20
NSUB	Substrate doping concentration	cm ⁻³	6e+16
RSH	Source-drain sheet resistance	Ω/□	0
RSHG	Gate sheet resistance	Ω/□	0.1
TOXE	Electrical gate oxide thickness in meters	m	3e-09
TOXM	Gate oxide thickness at which parameters are extracted	m	3e-09
TOXP	Physical gate oxide thickness in meters	m	3e-09
VBX	V _{th} transition body Voltage	V	0
XJ	Junction depth in meters	m	1.5e-07
XT	Doping depth	m	1.55e-07
<i>Tunnelling Parameters</i>			
AIGBACC	Parameter for I _{gb}	(F _s ² /g) ^{1/2} /m	0.0136
AIGBINV	Parameter for I _{gb}	(F _s ² /g) ^{1/2} /m	0.0111
AIGC	Parameter for I _{gc}	(F _s ² /g) ^{1/2} /m	0.0136
AIGD	Parameter for I _{gd}	(F _s ² /g) ^{1/2} /m	0.0136
AIGS	Parameter for I _{gs}	(F _s ² /g) ^{1/2} /m	0.0136
BIGBACC	Parameter for I _{gb}	(F _s ² /g) ^{1/2} /m	0.00171
BIGBINV	Parameter for I _{gb}	(F _s ² /g) ^{1/2} /m	0.000949
BIGC	Parameter for I _{gc}	(F _s ² /g) ^{1/2} /m	0.00171
BIGD	Parameter for I _{gd}	(F _s ² /g) ^{1/2} /m	0.00171
BIGS	Parameter for I _{gs}	(F _s ² /g) ^{1/2} /m	0.00171
CIGBACC	Parameter for I _{gb}	V ⁻¹	0.075
CIGBINV	Parameter for I _{gb}	V ⁻¹	0.006
CIGC	Parameter for I _{gc}	V ⁻¹	0.075
CIGD	Parameter for I _{gd}	V ⁻¹	0.075
CIGS	Parameter for I _{gs}	V ⁻¹	0.075
DLCIGD	Delta L for I _g model drain side	m	0
EIGBINV	Parameter for the Si bandgap for I _{gbinv}	V	1.1

Table 2-105. BSIM4 Device Model Parameters

Parameter	Description	Units	Default
NIGBACC	Parameter for Igbacc slope	–	1
NIGBINV	Parameter for Igbinv slope	–	3
NIGC	Parameter for Igc slope	–	1
NTOX	Exponent for Tox ratio	–	1
PIGCD	Parameter for Igc partition	–	1
POXEDGE	Factor for the gate edge Tox	–	1
TOXREF	Target tox value	m	3e-09
VFBSDOFF	S/D flatband voltage offset	V	0
<i>Asymmetric and Bias-Dependent R_{ds} Parameters</i>			
PRWB	Body-effect on parasitic resistance	V^{-1}	0
PRWG	Gate-bias effect on parasitic resistance	V^{-1}	1
RDSW	Source-drain resistance per width	$\Omega \mu m$	200
RDSWMIN	Source-drain resistance per width at high V_g	$\Omega \mu m$	0
RDW	Drain resistance per width	$\Omega \mu m$	100
RDWMIN	Drain resistance per width at high V_g	$\Omega \mu m$	0
RSW	Source resistance per width	$\Omega \mu m$	100
RSWMIN	Source resistance per width at high V_g	$\Omega \mu m$	0
WR	Width dependence of rds	–	1
<i>Impact Ionization Current Parameters</i>			
ALPHA0	substrate current model parameter	m/V	0
ALPHA1	substrate current model parameter	V^{-1}	0
BETA0	substrate current model parameter	V^{-1}	0
<i>Gate-induced Drain Leakage Model Parameters</i>			
AGIDL	Pre-exponential constant for GIDL	Ω^{-1}	0
AGISL	Pre-exponential constant for GISL	Ω^{-1}	0
BGIDL	Exponential constant for GIDL	Vm^{-1}	2.3e+09
BGISL	Exponential constant for GISL	Vm^{-1}	2.3e-09
CGIDL	Parameter for body-bias dependence of GIDL	V^3	0.5
CGISL	Parameter for body-bias dependence of GISL	V^3	0.5
EGIDL	Fitting parameter for Bandbending	V	0.8
EGISL	Fitting parameter for Bandbending	V	0.8
FGIDL [Only for versions starting with 4.7]	GIDL vb parameter	V	0
FGISL [Only for versions starting with 4.7]	Parameter for GISL body bias dependence	V	0

Table 2-105. BSIM4 Device Model Parameters

Parameter	Description	Units	Default
KGIDL [Only for versions starting with 4.7]	GIDL vb parameter	V	0
KGISL [Only for versions starting with 4.7]	Parameter for GISL body bias dependence	V	0
RGIDL [Only for versions starting with 4.7]	GIDL vg parameter	–	1
RGISL [Only for versions starting with 4.7]	Parameter for GISL gate bias dependence	–	1

2.3.20.8. Level 18 MOSFET Tables (VDMOS)

The vertical double-diffused power MOSFET model is based on the uniform charge control model (UCCM) developed at Rensselaer Polytechnic Institute [15]. The VDMOS current-voltage characteristics are described by a single, continuous analytical expression for all regimes of operation. The physics-based model includes effects such as velocity saturation in the channel, drain induced barrier lowering, finite output conductance in saturation, the quasi-saturation effect through a bias dependent drain parasitic resistance, effects of bulk charge, and bias dependent low-field mobility. An important feature of the implementation is the utilization of a single continuous expression for the drain current, which is valid below and above threshold, effectively removing discontinuities and improving convergence properties.

The following tables give parameters for the level 18 MOSFET.

Table 2-106. Power MOSFET Device Instance Parameters

Parameter	Description	Units	Default
<i>Control Parameters</i>			
M	Multiplier for M devices connected in parallel	–	1
<i>Geometry Parameters</i>			
AD	Drain diffusion area	m ²	0
AS	Source diffusion area	m ²	0
L	Channel length	m	0
NRD	Multiplier for RSH to yield parasitic resistance of drain	□	1
NRS	Multiplier for RSH to yield parasitic resistance of source	□	1
PD	Drain diffusion perimeter	m	0
PS	Source diffusion perimeter	m	0
W	Channel width	m	0
<i>Temperature Parameters</i>			
DTEMP	Device delta temperature	°C	0
TEMP	Device temperature	°C	Ambient Temperature

Table 2-107. Power MOSFET Device Model Parameters

Parameter	Description	Units	Default
AI		–	2e+09
ALPHA	Parameter accounting for the threshold dependence on the channel potential	–	0
ARTD		–	0
BI		–	8e+08

Table 2-107. Power MOSFET Device Model Parameters

Parameter	Description	Units	Default
BRTD		–	0.035
CBD	Zero-bias bulk-drain p-n capacitance	F	0
CBS	Zero-bias bulk-source p-n capacitance	F	0
CGBO	Gate-bulk overlap capacitance/channel length	F/m	0
CGDO	Gate-drain overlap capacitance/channel width	F/m	0
CGSO	Gate-source overlap capacitance/channel width	F/m	0
CJ	Bulk p-n zero-bias bottom capacitance/area	F/m ²	0
CJSW	Bulk p-n zero-bias sidewall capacitance/area	F/m ²	0
CRTD		–	0.1472
CV	Charge model storage selector	–	1
CVE	Meyer-like capacitor model selector	–	1
D1AF	Drain-source diode flicker noise exponent	–	1
D1BV	Drain-source diode reverse breakdown voltage	V	1e+99
D1CJO	Drain-source diode junction capacitance	F	0
D1EG	Drain-source diode activation energy	eV	1.11
D1FC	Drain-source diode forward bias depletion capacitance	–	0.5
D1IBV	Drain-source diode current at breakdown voltage	A	0.001
D1IKF	Drain-source diode high injection knee current	A	0
D1IS	Drain-Source diode saturation current	A	1e-14
D1ISR	Drain-source diode recombination saturation current	A	0
D1KF	Drain-source diode flicker noise coefficient	–	0
D1M	Drain-source diode grading coefficient	–	0.5
D1N	Drain-source diode emission coefficient	–	1
D1NR	Drain-source diode recombination emission coefficient	–	2
D1RS	Drain-source diode ohmic resistance	Ω	0
D1TNOM	Drain-source diode nominal temperature	°C	300.15
D1TT	Drain-source diode transit time	s	0
D1VJ	Drain-source diode junction potential	V	1
D1XTI	Drain-source diode sat. current temperature exponent	–	3
DELMAX		–	0.9
DELTA	Transition width parameter	–	5
DRIFTPARAMA	Drift region resistance intercept parameter	Ω	0.08
DRIFTPARAMB	Drift region resistance slope parameter	Ω V ⁻¹	0.013
DRTD		–	0.0052
ETA	Subthreshold ideality factor	–	1.32

Table 2-107. Power MOSFET Device Model Parameters

Parameter	Description	Units	Default
FC	Coefficient for forward-bias depletion capacitance formula	–	0.5
FPE	Charge partitioning scheme selector	–	1
GAMMAL0	Body effect constant in front of linear term	–	0
GAMMAS0	Body effect constant in front of square root term	V ^{-1/2}	0.5
IS	Bulk p-n saturation current	A	1e-14
ISUBMOD		–	0
JS	Bulk p-n saturation current density	A/m ²	0
K		–	0
KVS		–	0
KVT		–	0
L0	Gate length of nominal device	m	0
LAMBDA	Output conductance parameter	V ⁻¹	0.048
LD	Lateral diffusion length	m	0
LGAMMAL	Sensitivity of gL on device length	–	0
LGAMMAS	Sensitivity of gS on device length	V ^{-1/2}	0
LS		–	3.5e-08
M	Knee shape parameter	–	4
MC		–	3
MCV	Transition width parameter used by the charge partitioning scheme	–	10
MD		–	2
MDTEMP		–	0
MJ	Bulk p-n bottom grading coefficient	–	0.5
MJSW	Bulk p-n sidewall grading coefficient	–	0.5
MTH		–	0
N2		–	1
NRTD		–	0.115
NSS	Surface state density	cm ⁻²	0
NSUB	Substrate doping density	cm ⁻³	0
PB	Bulk p-n bottom potential	V	0.8
PHI	Surface potential	V	0.6
RD	Drain ohmic resistance	Ω	0
RDSSHUNT	Drain-source shunt resistance	Ω	0
RG	Gate ohmic resistance	Ω	0
RS	Source ohmic resistance	Ω	0

Table 2-107. Power MOSFET Device Model Parameters

Parameter	Description	Units	Default
RSH	Drain,source diffusion sheet resistance	Ω	0
RSUB		–	0
SIGMA0	DIBL parameter	–	0.048
TEMPMODEL	Specifies the type of parameter interpolation over temperature	–	'NONE'
THETA	Mobility degradation parameter	m/V	0
TNOM	Nominal device temperature	$^{\circ}\text{C}$	Ambient Temperature
TOX	Gate oxide thickness	m	1e-07
TPG	Gate material type (-1 = same as substrate, 0 = aluminum, 1 = opposite of substrate)	–	1
TS		–	0
TVS		–	0
U0	Surface mobility	1/(Vcm ² s)	280
UO	Surface mobility	1/(Vcm ² s)	280
VFB	Flat band voltage	V	0
VMAX	Maximum drift velocity for carriers	m/s	40000
VP		–	0
VSIGMA	DIBL parameter	V	0.2
VSIGMAT	DIBL parameter	V	1.7
VTO	Zero-bias threshold voltage	V	0
W0	Gate width of nominal device	m	0
WGAMMAL	Sensitivity of gL on device width	–	0
WGAMMAS	Sensitivity of gS on device width	V ^{-1/2}	0
XJ	Metallurgical junction depth	m	0
XQC	Charge partitioning factor	–	0.6

2.3.20.9. Levels 70 and 70450 MOSFET Tables (BSIM-SOI 4.6.1 and 4.5.0)

For complete documentation of the BSIM-SOI model, see the users' manual for the BSIM-SOI, available for download at <http://bsim.berkeley.edu/models/bsimsoi/>. Xyce implements Version 4.6.1 of the BSIM-SOI as the level 70 device and version 4.5.0 as level 70450.

Instance and model parameters of the level 70 MOSFET are given in tables 2-108 and 2-109.

Beginning with Xyce 7.2, the BSIM-SOI models level 70 and 70450 have *limited* support for the optional 5th, 6th, and 7th nodes. See the BSIM-SOI technical manual at the BSIM web site for details of what configurations the full device supports. Only some of these use cases are supported: Use of the BSIM-SOI 4.x with TNODEOUT=0 (the default) is supported in 4-, 5-, 6-, and 7-node configurations. TNODEOUT=1 is supported only in the 7-node configuration, with the 7th node being temperature. No access to the external temperature node is available in 5- or 6- node configuration.

When TNODEOUT=0, the temperature node is an internal node of the device even when not specified on the instance line, and its value may still be printed using the N() notation (see section 2.1.31.12). This somewhat minimizes the impact of the lack of support for TNODEOUT=1 in Xyce — the temperature rise due to self-heating is always available for printing, but it is not available for creation of a thermal coupling network except in the 7-node configuration.

Note that with some choices of model parameters, the BSIM-SOI devices attempt to “collapse” the “P” and “B” nodes (external and internal body nodes, 5th and 6th netlist nodes if given, internal nodes if not given). Xyce is unable to perform such collapse when the nodes are externally specified, and will issue warnings when it finds the model trying to do so. Depending on the actual nodes used for P and B, the device may fail to converge or produce invalid results; as an example, if P and B are actually specified on the netlist line to be the same node, this failure to collapse will not matter — the nodes are already the same. But if two different node names are used for the 5th and 6th nodes, the failure to collapse will leave one node floating and the simulation will likely fail if the printed warnings are ignored.

A similar problem exists for other choices of model parameter: in some cases neither the “P” nor “B” nodes are used, and if the nodes are specified on the netlist line the BSIM-SOI code attempts to collapse them to ground. This is not something Xyce can do, and therefore instead Xyce ignores the specified nodes. This can leave those nodes floating and lead to convergence failures unless the specified nodes are already the ground node (node 0). Xyce will issue appropriate warnings when this condition exists and suggest removal of the unused external nodes from the instance line.

The BSIM SOI 4.6.1 device supports output of the internal variables in table 2-110 on the .PRINT line of a netlist. To access them from a print line, use the syntax N(<instance>:<variable>) where “<instance>” refers to the name of the specific level 70 M device in your netlist.

NOTE: It has been observed that the gate capacitance model of BSIM-SOI 4.6.1 behaves differently than earlier versions, and the team has seen significant disagreement of gate currents when comparing identical simulations with other simulators that have only earlier BSIM-SOI models. For this reason, we are also providing BSIM-SOI 4.5.0 as the level 70450 MOSFET. This model does agree with these other simulators. The parameters and output variables are given in tables 2-111, 2-112, and 2-113. Unlike BSIM-SOI 4.6.1, the 4.5.0 model's original Verilog-A source code does not contain descriptions and units for the parameters, and these appear blank in the tables. For descriptions and units, see the corresponding parameters in the level 70 tables.

Table 2-108. BSIM-SOI 4.6.1 Device Instance Parameters

Parameter	Description	Units	Default
AD	Drain area	m ²	0
AEBCP	Substrate to body overlap area for bc parasitics	m ²	0
AGBCP	Gate to body overlap area for bc parasitics	m ²	0
AGBCP2	Parasitic Gate to body overlap area for bc parasitics /* v4.1 improvement on BC	m ²	0
AGBCPD	Gate to body overlap area for bc parasitics in DC	m ²	0
AS	Source area	m ²	0
BJTOFF	BJT on/off flag	—	0
CTH0	Instance Thermal Capacitance	—	1e-05
DEBUG	DEBUG on/off flag	—	0
DELVTO	Zero bias threshold voltage variation	V	0
DTEMP	device temperature offset from ambient	—	0
FRBODY	layout dependent body-resistance coefficient	—	1
L	Length	m	5e-06
M	multiplicity factor	—	1
NBC	Number of body contact isolation edge	—	0
NF	Number of fingers	—	1
NRB	Number of squares in body	—	1
NRD	Number of squares in drain	—	1
NRS	Number of squares in source	—	1
NSEG	Number segments for width partitioning	—	1
OFF	Device is initially off	—	0
PD	Drain perimeter	m	0
PDBCP	Perimeter length for bc parasitics at drain side	m	0
PS	Source perimeter	m	0
PSBCP	Perimeter length for bc parasitics at source side	m	0
RBDB	Body resistance	—	50
RBSB	Body resistance	—	50
RTH0	Instance Thermal Resistance	—	0
SA	distance between OD edge to poly of one side	m	0
SB	distance between OD edge to poly of the other side	m	0
SD	distance between neighbor fingers	m	0
SHMOD	Self heating mode selector	—	0
SOIMOD	Instance model selector for PD/FD operation /* v3.2	—	0
TNODEOUT	Flag indicating external temp node	—	0
W	Width	m	5e-06

Table 2-109. BSIM-SOI 4.6.1 Device Model Parameters

Parameter	Description	Units	Default
A0	Non-uniform depletion width effect coefficient.	—	1
A1	Non-saturation effect coefficient	—	0
A2	Non-saturation effect coefficient	—	1
ABJTII	Exponent factor for avalanche current	—	0
ACDE	Exponential coefficient for charge thickness in capMod=3 for accumulation and depletion regions	m/V	1
AD	Drain area	m ²	0
ADOS	Charge centroid parameter	—	1
AEBCP	Substrate to body overlap area for bc parasitics	m ²	0
AELY	Channel length dependency of early voltage for bipolar current	—	0
AF	Flicker noise exponent	—	1
AGB1	'A' for Igb1 Tunneling current model	—	3.7622e-07
AGB2	'A' for Igb2 Tunneling current model	—	4.9758e-07
AGBC2N	NMOS 'A' for tunneling current model	—	3.4254e-07
AGBC2P	PMOS 'A' for tunneling current model	—	4.9723e-07
AGBCP	Gate to body overlap area for bc parasitics	m ²	0
AGBCP2	Parasitic Gate to body overlap area for bc parasitics /* v4.1 improvement on BC	m ²	0
AGBCPD	Gate to body overlap area for bc parasitics in DC	m ²	0
AGIDL	GIDL second parameter	—	0
AGISL	GISL second parameter	—	0
AGS	Gate bias coefficient of Abulk.	—	0
AHLI	High level injection parameter for bipolar current /* v4.0	—	0
AHLID	High level injection parameter for bipolar current /* v4.0	—	0
AIGBCP2	First Vgp dependent parameter for gate current in accumulation in AGBCP2 region	—	0.043
AIGC	Parameter for Igc	—	0
AIGSD	Parameter for Igs,d	—	0
ALPHA0	substrate current model parameter	m/V	0
ALPHAGB1	First Vox dependent parameter for gate current in inversion	—	0.35
ALPHAGB2	First Vox dependent parameter for gate current in accumulation	—	0.43
AS	Source area	m ²	0
ASD	Source/drain bottom diffusion smoothing parameter	—	0.3

Table 2-109. BSIM-SOI 4.6.1 Device Model Parameters

Parameter	Description	Units	Default
AT	Temperature coefficient of vsat	—	33000
B0	Abulk narrow width parameter	m	0
B1	Abulk narrow width parameter	m	0
BDOS	Charge centroid parameter	—	1
BETA0	First Vds dependent parameter of impact ionization current	—	0
BETA1	Second Vds dependent parameter of impact ionization current	—	0
BETA2	Third Vds dependent parameter of impact ionization current	V	0.1
BETAGB1	Second Vox dependent parameter for gate current in inversion	—	0.03
BETAGB2	Second Vox dependent parameter for gate current in accumulation	—	0.05
BF	Flicker noise length dependence exponent	—	2
BG0SUB	Band-gap of substrate at T=0K	—	1.16
BGB1	'B' for Igb1 Tunneling current model	—	-3.1051e+10
BGB2	'B' for Igb2 Tunneling current model	—	-2.357e+10
BGBC2N	NMOS 'B' for tunneling current model	—	1.1665e+12
BGBC2P	PMOS 'B' for tunneling current model	—	7.4567e+11
BGIDL	GIDL third parameter	—	2.3e+09
BGISL	GISL third parameter	—	0
BIGBCP2	Second Vgp dependent parameter for gate current in accumulation in AGBCP2 region	—	0.0054
BIGC	Parameter for Igc	—	0
BIGSD	Parameter for Igs,d	—	0
BINUNIT	Bin unit selector	—	1
BJTOFF	BJT on/off flag	—	0
CAPMOD	Capacitance model selector	—	2
CBJTII	Length scaling parameter for II BJT part	m	0
CDSBS	coupling from Vd to Vbs for improved dVbi model	—	0
CDSC	Drain/Source and channel coupling capacitance	—	0.00024
CDSCB	Body-bias dependence of cdsc	—	0
CDSCD	Drain-bias dependence of cdsc	—	0
CF	Fringe capacitance parameter	—	0
CFRCOEFF	Fringe Cap parameter /* v4.4	—	1
CGDL	New C-V model parameter	—	0
CGDO	Gate-drain overlap capacitance per width	—	0

Table 2-109. BSIM-SOI 4.6.1 Device Model Parameters

Parameter	Description	Units	Default
CGEO	Gate substrate overlap capacitance per unit channel length	—	0
CGIDL	GIDL vb parameter	—	0.5
CGISL	GISL vb parameter	—	0
CGSL	New C-V model parameter	—	0
CGSO	Gate-source overlap capacitance per width	—	0
CIGBCP2	Third V _{gp} dependent parameter for gate current in accumulation in AGBCP2 region	—	0.0075
CIGC	Parameter for I _{gc}	—	0
CIGSD	Parameter for I _{gs,d}	—	0
CIT	Interface state capacitance	—	0
CJSWG	Source(gate side) sidewall junction capacitance per unit width /* v4.0	—	1e-10
CJSWGD	Drain (gate side) sidewall junction capacitance per unit width /* v4.0	—	0
CKAPPA	New C-V model parameter	—	0.6
CLC	V _{dsat} parameter for C-V model	m	1e-08
CLE	V _{dsat} parameter for C-V model	—	0
CSDESW	Source/drain sidewall fringing capacitance per unit length	—	0
CSDMIN	Source/drain bottom diffusion minimum capacitance	V	0
CTH0	Instance Thermal Capacitance	—	1e-05
DELTA	Effective V _{ds} parameter	—	0.01
DELTAVOX	the smoothing parameter in the Vox smoothing function	—	0.005
DELVT	Threshold voltage adjust for CV	V	0
DELVTO	Zero bias threshold voltage variation	V	0
DK2B	third backgate body effect parameter for short channel effect	—	0
DLBG	Length offset fitting parameter for backgate charge	m	0
DLC	Delta L for C-V model	m	0
DLCB	Length offset fitting parameter for body charge	m	0
DLCIG	Delta L for I _g model	m	0
DROUT	DIBL coefficient of output resistance	—	0.56
DSUB	DIBL coefficient in the subthreshold region	—	0
DTOXCV	Delta oxide thickness in meters in CapMod3 /* v2.2.3	m	0
DVBD0	first short-channel effect parameter in FD module	—	0
DVBD1	second short-channel effect parameter in FD module	—	0

Table 2-109. BSIM-SOI 4.6.1 Device Model Parameters

Parameter	Description	Units	Default
DVT0	Short channel effect coeff. 0	—	2.2
DVT0W	Narrow Width coeff. 0	—	0
DVT1	Short channel effect coeff. 1	—	0.53
DVT1W	Narrow Width effect coeff. 1	—	5.3e+06
DVT2	Short channel effect coeff. 2	—	-0.032
DVT2W	Narrow Width effect coeff. 2	—	-0.032
DVTP0	First parameter for Vth shift due to pocket	m	0
DVTP1	Second parameter for Vth shift due to pocket	—	0
DVTP2	Third parameter for Vth shift due to pocket	—	0
DVTP3	Third parameter for Vth shift due to pocket	—	0
DVTP4	Forth parameter for Vth shift due to pocket	—	0
DWB	Width reduction parameter	—	0
DWBC	Width offset for body contact isolation edge	m	0
DWC	Delta W for C-V model	m	0
DWG	Width reduction parameter	m/V	0
EASUB	Electron affinity of substrate	—	4.05
EBG	effective bandgap in gate current calculation	—	1.2
EBJTII	Impact ionization parameter for BJT part	—	0
EF	Flicker noise frequency exponent	—	1
EGBCP2	Bandgap in Agbcp2 region	—	1.12
EGGDEP	Bandgap for gate depletion effect	—	1.12
EGIDL	GIDL first parameter	V	0
EGISL	GISL first parameter	V	0
EM	Flicker noise parameter	—	4.1e+07
EOT	Effective SiO2 thickness	m	1e-08
EPSRGATE	Dielectric constant of gate relative to vacuum	—	11.7
EPSROX	Dielectric constant of the gate oxide relative to vacuum	—	3.9
EPSRSUB	Dielectric constant of substrate relative to vacuum	—	11.7
ESATII	Saturation electric field for impact ionization	—	1e+07
ETA0	Subthreshold region DIBL coefficient for I-V	—	0.08
ETA0CV	Subthreshold region DIBL coefficient for C-V	—	0
ETAB	Subthreshold region DIBL coefficient for I-V	—	-0.07
ETABCV	Subthreshold region DIBL coefficient for C-V	—	0
ETSI	Effective Silicon-on-insulator thickness in meters	m	1e-07
EU	Mobility exponent	—	0

Table 2-109. BSIM-SOI 4.6.1 Device Model Parameters

Parameter	Description	Units	Default
FBJTII	Fraction of bipolar current affecting the impact ionization	—	0
FBODY	Scaling factor for body charge	—	1
FDMOD	Improved dVbi model selector	—	0
FGIDL	GIDL vb parameter	—	0
FGISL	GISL vb parameter	V	0
FNOIMOD	Flicker noise model selector	—	1
FPROUT	Rout degradation coefficient for pocket devices	—	0
FRBODY	layout dependent body-resistance coefficient	—	1
GAMMA1	Vth body coefficient	—	0
GAMMA2	Vth body coefficient	—	0
GBMIN	Minimum body conductance	—	1e-12
GIDLMOD	parameter for GIDL selector	—	0
IDBJT	BJT injection saturation current	—	0
IDDIF	Body to source/drain injection saturation current /* v4.0	—	0
IDREC	Recombination in depletion saturation current	—	0
IDTUN	Reverse tunneling saturation current	—	0
IGBMOD	gate-body tunneling current model selector /* v3.0	—	0
IGCMOD	gate-channel tunneling current model selector /* v3.0	—	0
IGMOD	gate-body tunneling current model selector /* v3.1.1	—	0
IIIMOD	parameter for III selector	—	0
ISBJT	BJT injection saturation current	—	1e-06
ISDIF	Body to source/drain injection saturation current	—	0
ISREC	Recombination in depletion saturation current	—	1e-05
ISTUN	Reverse tunneling saturation current	—	0
K1	Bulk effect coefficient 1	—	0.53
K1B	first backgate body effect parameter	—	1
K1W1	First Body effect width dependent parameter	m	0
K1W2	Second Body effect width dependent parameter	m	0
K2	Bulk effect coefficient 2	—	-0.0186
K2B	second backgate body effect parameter for short channel effect	—	0
K3	Narrow width effect coefficient	—	0
K3B	Body effect coefficient of k3	—	0
KB1	Scaling factor for backgate charge	—	1

Table 2-109. BSIM-SOI 4.6.1 Device Model Parameters

Parameter	Description	Units	Default
KETA	Body-bias coefficient of non-uniform depletion width effect.	—	-0.6
KETAS	Surface potential adjustment for bulk charge effect	V	0
KF	Flicker noise coefficient	—	0
KGIDL	GIDL vb parameter	V	0
KGISL	GISL vb parameter	V	0
KT1	Temperature coefficient of Vth	V	-0.11
KT1L	Temperature coefficient of Vth	—	0
KT2	Body-coefficient of kt1	—	0.022
KU0	Mobility degradation/enhancement coefficient for LOD	m	0
KVSAT	Saturation velocity degradation/enhancement parameter for LOD	m	0
KVTH0	Threshold degradation/enhancement parameter for LOD	Vm	0
L	Length	m	5e-06
LA0	Length dependence of a0	—	0
LA1	Length dependence of a1	—	0
LA2	Length dependence of a2	—	0
LABJTII	Length dependence of abjtii	—	0
LACDE	Length dependence of acde	—	0
LAELY	Length dependence of aely	—	0
LAGIDL	Length dependence of agidl	—	0
LAGISL	Length dependence of agisl	—	0
LAGS	Length dependence of ags	—	0
LAHLI	Length dependence of ahli /*v4.0	—	0
LAHLID	Length dependence of ahlid /*v4.0	—	0
LAIGBCP2	Length dependence of aigbcp2	—	0
LAIGC	Length dependence of aigc	—	0
LAIGSD	Length dependence of aigsd	—	0
LALPHA0	Length dependence of alpha0	—	0
LALPHAGB1	Length dependence of alphagb1	—	0
LALPHAGB2	Length dependence of alphagb2	—	0
LAT	Length dependence of at	—	0
LB0	Length dependence of b0	—	0
LB1	Length dependence of b1	—	0
LBETA0	Length dependence of beta0	—	0

Table 2-109. BSIM-SOI 4.6.1 Device Model Parameters

Parameter	Description	Units	Default
LBETA1	Length dependence of beta1	—	0
LBETA2	Length dependence of beta2	—	0
LBETAGB1	Length dependence of betagb1	—	0
LBETAGB2	Length dependence of betagb2	—	0
LBGIDL	Length dependence of bgidl	—	0
LBGISL	Length dependence of bgisl	—	0
LBIGBCP2	Length dependence of bigbcp2	—	0
LBIGC	Length dependence of bigc	—	0
LBIGSD	Length dependence of bigsd	—	0
LBJT0	Reference channel length for bipolar current	m	2e-07
LCBJTII	Length dependence of cbjtii	—	0
LCDSBS	Length dependence of cdsbs	—	0
LCDSC	Length dependence of cdsc	—	0
LCDSB	Length dependence of cdscb	—	0
LCDSCD	Length dependence of cdscd	—	0
LCGDL	Length dependence of cgd1	—	0
LCGIDL	Length dependence of cgidl	—	0
LCGISL	Length dependence of cgisl	—	0
LCGSL	Length dependence of cgsl	—	0
LCIGBCP2	Length dependence of cigbcp2	—	0
LCIGC	Length dependence of cigc	—	0
LCIGSD	Length dependence of cigsd	—	0
LCIT	Length dependence of cit	—	0
LCKAPPA	Length dependence of ckappa	—	0
LDELTA	Length dependence of delta	—	0
LDELVT	Length dependence of delvt	—	0
LDIF0	Channel-length dependency coefficient of diffusion cap	—	1
LDK2B	Length dependence of dk2b	—	0
LDROUT	Length dependence of drout	—	0
LDSUB	Length dependence of dsub	—	0
LDVBD0	Length dependence of dvbd0	—	0
LDVBD1	Length dependence of dvbd1	—	0
LDVT0	Length dependence of dvt0	—	0
LDVT0W	Length dependence of dvt0w	—	0
LDVT1	Length dependence of dvt1	—	0

Table 2-109. BSIM-SOI 4.6.1 Device Model Parameters

Parameter	Description	Units	Default
LDVT1W	Length dependence of dvt1w	—	0
LDVT2	Length dependence of dvt2	—	0
LDVT2W	Length dependence of dvt2w	—	0
LDVTP0	Length dependence of dvtp0	—	0
LDVTP1	Length dependence of dvtp1	—	0
LDVTP2	Length dependence of dvtp2	—	0
LDVTP3	Length dependence of dvtp3	—	0
LDVTP4	Length dependence of dvtp4	—	0
LDWB	Length dependence of dwb	—	0
LDWG	Length dependence of dwg	—	0
LEBJTII	Length dependence of ebjtii	—	0
LEFFEOT	Effective length for extraction of EOT	—	1
LEGIDL	Length dependence of egidl	—	0
LEGISL	Length dependence of egisl	—	0
LESATII	Length dependence of esatii	—	0
LETA0	Length dependence of eta0	—	0
LETA0CV	Length dependence of eta0cv	—	0
LETAB	Length dependence of etab	—	0
LETABCV	Length dependence of etabcv	—	0
LEU	Length dependence of eu	—	0
LFBJTII	Length dependence of fbjtii	—	0
LFGIDL	Length dependence of fgidl	—	0
LFGISL	Length dependence of fgisl	—	0
LFPROUT	Length dependence of pdiblecb	—	0
LIDBJT	Length dependence of idbjt	—	0
LIDDIF	Length dependence of iddif	—	0
LIDREC	Length dependence of idrec	—	0
LIDTUN	Length dependence of idtun	—	0
LII	Channel length dependent parameter at threshold for impact ionization current	—	0
LINT	Length reduction parameter	m	0
LISBJT	Length dependence of isbjt	—	0
LISDIF	Length dependence of isdif	—	0
LISREC	Length dependence of isrec	—	0
LISTUN	Length dependence of istun	—	0
LK1	Length dependence of k1	—	0

Table 2-109. BSIM-SOI 4.6.1 Device Model Parameters

Parameter	Description	Units	Default
LK1B	Length dependence of k1b	—	0
LK1W1	Length dependence of k1w1	—	0
LK1W2	Length dependence of k1w2	—	0
LK2	Length dependence of k2	—	0
LK2B	Length dependence of k2b	—	0
LK3	Length dependence of k3	—	0
LK3B	Length dependence of k3b	—	0
LKB1	Length dependence of kb1	—	0
LKETA	Length dependence of keta	—	0
LKETAS	Length dependence of ketas	—	0
LKGIDL	Length dependence of kgidl	—	0
LKGISL	Length dependence of kgisl	—	0
LKT1	Length dependence of kt1	—	0
LKT1L	Length dependence of kt1l	—	0
LKT2	Length dependence of kt2	—	0
LKU0	Length dependence of ku0	—	0
LKVTH0	Length dependence of kvth0	—	0
LL	Length reduction parameter	m	0
LLBJT0	Length dependence of lbjt0	—	0
LLC	Length reduction parameter /* v2.2.3	—	0
LLII	Length dependence of lii	—	0
LLN	Length reduction parameter	—	1
LLODKU0	Length parameter for u0 LOD effect	—	0
LLODVTH	Length parameter for vth LOD effect	—	0
LLPE0	Length dependence of lpe0	—	0
LLPEB	Length dependence of lpeb	—	0
LMBJTII	Length dependence of mbjtii	—	0
LMINV	Length dependence of minv	—	0
LMINVCV	Length dependence of minvcv	—	0
LMOIN	Length dependence of moin	—	0
LMOINFD	Length dependence of moinfeld	—	0
LN	Electron/hole diffusion length	m	2e-06
LNBjt	Length dependence of nbjt	—	0
LNCH	Length dependence of nch	—	0
LNDIF	Length dependence of ndif	—	0
LNDIODE	Length dependence of ndiode	—	0

Table 2-109. BSIM-SOI 4.6.1 Device Model Parameters

Parameter	Description	Units	Default
LNDIODED	Length dependence of ndioded	—	0
LNFACTOR	Length dependence of nfactor	—	0
LNGATE	Length dependence of ngate	—	0
LNGIDL	Length dependence of ngidl	—	0
LNIGC	Length dependence of nigc	—	0
LNLX	Length dependence of nlx	—	0
LNOFF	Length dependence of noff /* v3.2	—	0
LNOFF2	Length dependence of noff2 /* v4.6	—	0
LNOFFFD	Length dependence of nofffd	—	0
LNRECF0	Length dependence of nrecf0	—	0
LNRECF0D	Length dependence of nrecf0d	—	0
LNRECR0	Length dependence of nrecr0	—	0
LNRECR0D	Length dependence of nrecr0d	—	0
LNSD	Length dependence of nsd	—	0
LNSUB	Length dependence of nsub	—	0
LNTRECF	Length dependence of ntrecf	—	0
LNTRECR	Length dependence of ntrecr	—	0
LNTUN	Length dependence of ntun	—	0
LNTUND	Length dependence of ntund	—	0
LODETA0	eta0 shift modification factor for stress effect	—	1
LODETA0CV	eta0cv shift modification factor for stress effect	—	0
LODK2	K2 shift modification factor for stress effect	—	1
LPCLM	Length dependence of pclm	—	0
LPDIBLC1	Length dependence of pdiblc1	—	0
LPDIBLC2	Length dependence of pdiblc2	—	0
LPDIBLCB	Length dependence of pdiblcb	—	0
LPDITS	Length dependence of pdits	—	0
LPDITSD	Length dependence of pditsd	—	0
LPE0	Lateral non-uniform doping effect	m	0
LPEB	Lateral non-uniform doping effect for body bias	m	0
LPIGCD	Length dependence for pigcd	—	0
LPOXEDGE	Length dependence for poxedge	—	0
LPRT	Length dependence of prt	—	0
LPRWB	Length dependence of prwb	—	0
LPRWG	Length dependence of prwg	—	0
LPVAG	Length dependence of pvag	—	0

Table 2-109. BSIM-SOI 4.6.1 Device Model Parameters

Parameter	Description	Units	Default
LRDSW	Length dependence of rdsw	—	0
LRDW	Length dependence of rdw /* v4.0	—	0
LRGIDL	Length dependence of rgidl	—	0
LRGISL	Length dependence of rgisl	—	0
LRSW	Length dependence of rsw /* v4.0	—	0
LSII0	Length dependence of sii0	—	0
LSII1	Length dependence of sii1	—	0
LSII2	Length dependence of sii2	—	0
LSIID	Length dependence of siid	—	0
LU0	Length dependence of u0	—	0
LUA	Length dependence of ua	—	0
LUA1	Length dependence of ua1	—	0
LUB	Length dependence of ub	—	0
LUB1	Length dependence of ub1	—	0
LUC	Length dependence of uc	—	0
LUC1	Length dependence of uc1	—	0
LUCS	Length dependence of lucs	—	0
LUCSTE	Length dependence of ucste	—	0
LUD	Length dependence of ud	—	0
LUD1	Length dependence of ud1	—	0
LUTE	Length dependence of ute	—	0
LVABJT	Length dependence of vabjt	—	0
LVBCI	Length dependence of vbci	—	0
LVBS0FD	Length dependence of vbs0fd	—	0
LVBS0PD	Length dependence of vbs0pd	—	0
LVBSA	Length dependence of vbsa	—	0
LVDSATII0	Length dependence of vdsatii0	—	0
LVFB	Length dependence of vfb /* v4.1	—	0
LVOFF	Length dependence of voff	—	0
LVOFFCV	Length dependence of voffcv	—	0
LVOFFFD	Length dependence of vofffd	—	0
LVREC0	Length dependence of vrec0	—	0
LVREC0D	Length dependence of vrec0d	—	0
LVSAT	Length dependence of vsat	—	0
LVSCE	Length dependence of vsce	—	0
LVSDFB	Length dependence of vsdfb	—	0

Table 2-109. BSIM-SOI 4.6.1 Device Model Parameters

Parameter	Description	Units	Default
LVSDTH	Length dependence of vsdth	—	0
LVTH0	Length dependence of vto	—	0
LVTUN0	Length dependence of vtun0	—	0
LVTUN0D	Length dependence of vtun0d	—	0
LW	Length reduction parameter	m	0
LW0	Length dependence of w0	—	0
LWC	Length reduction parameter /* v2.2.3	—	0
LWL	Length reduction parameter	—	0
LWLC	Length reduction parameter /* v2.2.3	—	0
LWN	Length reduction parameter	—	1
LWR	Length dependence of wr	—	0
LXBJT	Length dependence of xbjt	—	0
LXDIF	Length dependence of xdif	—	0
LXDIFD	Length dependence of xdifd	—	0
LXJ	Length dependence of xj	—	0
LXRCRG1	Length dependence of xrcrg1	—	0
LXRCRG2	Length dependence of xrcrg2	—	0
LXREC	Length dependence of xrec	—	0
LXRECD	Length dependence of xrecd	—	0
LXTUN	Length dependence of xtun	—	0
LXTUND	Length dependence of xtund	—	0
MBJTII	Internal B-C grading coefficient	—	0.4
MINV	For moderate inversion in Vgsteff	—	0
MINVCV	For moderate inversion in VgsteffCV	—	0
MJSWG	Source (gate side) sidewall junction capacitance grading coefficient /* v4.0	V	0.5
MJSWGD	Drain (gate side) sidewall junction capacitance grading coefficient /* v4.0	V	0
MOBMOD	Mobility model selector	—	1
MOIN	Coefficient for the gate-bias dependent surface potential	—	15
MOINFD	Coefficient for the gate-bias dependent surface potential in FD	—	1000
MTRLMOD	parameter for non-silicon substrate or metal gate selector	—	0
NBC	Number of body contact isolation edge	—	0
NBJT	Power coefficient of channel length dependency for bipolar current	—	1

Table 2-109. BSIM-SOI 4.6.1 Device Model Parameters

Parameter	Description	Units	Default
NCH	Channel doping concentration	—	1.7e+17
NDIF	Power coefficient of channel length dependency for diffusion capacitance	—	-1
NDIODE	Diode non-ideality factor /*v4.0	—	1
NDIODED	Diode non-ideality factor /*v4.0	—	0
NF	Number of fingers	—	1
NFACTOR	Subthreshold swing Coefficient	—	1
NGATE	Poly-gate doping concentration	—	0
NGCON	Number of gate contacts	—	1
NGIDL	GIDL first parameter	—	1.2
NI0SUB	Intrinsic carrier concentration of substrate at Tnom	—	1.45e+10
NIGC	Parameter for Igc slope	—	1
NLX	Lateral non-uniform doping effect	m	1.74e-07
NODECHK	NODE checking flag	—	1
NOFF	C-V turn-on/off parameter /* v3.2	—	1
NOFF2	C-V turn-on/off parameter /* v4.6	—	0
NOFFFD	smoothing parameter in FD module	—	1
NOIA	Flicker noise parameter	—	0
NOIB	Flicker noise parameter	—	0
NOIC	Flicker noise parameter	—	8.75e+09
NOIF	Floating body excess noise ideality factor	—	1
NRB	Number of squares in body	—	1
NRD	Number of squares in drain	—	1
NRECF0	Recombination non-ideality factor at forward bias	—	2
NRECF0D	Recombination non-ideality factor at forward bias	—	0
NRECR0	Recombination non-ideality factor at reversed bias	—	10
NRECR0D	Recombination non-ideality factor at reversed bias	—	0
NRS	Number of squares in source	—	1
NSD	S/D doping concentration	—	1e+20
NSEG	Number segments for width partitioning	—	1
NSUB	Substrate doping concentration with polarity	—	6e+16
NTNOI	Thermal noise parameter	—	1
NTOX	power term of gate current	—	1
NTRECF	Temperature coefficient for Nrecf	—	0
NTRECR	Temperature coefficient for Nrecr	—	0
NTUN	Reverse tunneling non-ideality factor	—	10

Table 2-109. BSIM-SOI 4.6.1 Device Model Parameters

Parameter	Description	Units	Default
NTUND	Reverse tunneling non-ideality factor	—	0
OFF	Device is initially off	—	0
PA0	Cross-term dependence of a0	—	0
PA1	Cross-term dependence of a1	—	0
PA2	Cross-term dependence of a2	—	0
PABJTII	Cross-term dependence of abjtii	—	0
PACDE	Cross-term dependence of acde	—	0
PAELY	Cross-term dependence of aely	—	0
PAGIDL	Cross-term dependence of agidl	—	0
PAGISL	Cross-term dependence of agisl	—	0
PAGS	Cross-term dependence of ags	—	0
PAHLI	X-term dependence of ahli /* v4.0	—	0
PAHLID	X-term dependence of ahlid /* v4.0	—	0
PAIGBCP2	Cross-term dependence of aigbcp2	—	0
PAIGC	Cross-term dependence of aigc	—	0
PAIGSD	Cross-term dependence of aigsd	—	0
PALPHA0	Cross-term dependence of alpha0	—	0
PALPHAGB1	Cross-term dependence of alphagb1	—	0
PALPHAGB2	Cross-term dependence of alphagb2	—	0
PARAMCHK	Model parameter checking selector	—	0
PAT	Cross-term dependence of at	—	0
PB0	Cross-term dependence of b0	—	0
PB1	Cross-term dependence of b1	—	0
PBETA0	Cross-term dependence of beta0	—	0
PBETA1	Cross-term dependence of beta1	—	0
PBETA2	Cross-term dependence of beta2	—	0
PBETAGB1	Cross-term dependence of betagb1	—	0
PBETAGB2	Cross-term dependence of betagb2	—	0
PBGIDL	Cross-term dependence of bgidl	—	0
PBGISL	Cross-term dependence of bgisl	—	0
PBIGBCP2	Cross-term dependence of bigbcp2	—	0
PBIGC	Cross-term dependence of bigc	—	0
PBIGSD	Cross-term dependence of bigsd	—	0
PBSWG	Source(gate side) sidewall junction capacitance built in potential /* v4.0	V	0.7

Table 2-109. BSIM-SOI 4.6.1 Device Model Parameters

Parameter	Description	Units	Default
PBSWGD	Drain(gate side) sidewall junction capacitance built in potential /* v4.0	V	0
PCBJTII	Cross-term dependence of cbjtii	—	0
PCDSBS	Cross-term dependence of cdsbs	—	0
PCDSC	Cross-term dependence of cdsc	—	0
PCDSCB	Cross-term dependence of cdsbc	—	0
PCDSCD	Cross-term dependence of cdsdc	—	0
PCGDL	Cross-term dependence of cgdl	—	0
PCGIDL	Cross-term dependence of cgidl	—	0
PCGISL	Cross-term dependence of cgisl	—	0
PCGSL	Cross-term dependence of cgsl	—	0
PCIGBCP2	Cross-term dependence of cigbcp2	—	0
PCIGC	Cross-term dependence of cigc	—	0
PCIGSD	Cross-term dependence of cigsd	—	0
PCIT	Cross-term dependence of cit	—	0
PCKAPPA	Cross-term dependence of ckappa	—	0
PCLM	Channel length modulation Coefficient	—	1.3
PD	Drain perimeter	m	0
PDBCP	Perimeter length for bc parasitics at drain side	m	0
PDELTA	Cross-term dependence of delta	—	0
PDELVT	Cross-term dependence of delvt	—	0
PDIBLC1	Drain-induced barrier lowering coefficient	—	0.39
PDIBLC2	Drain-induced barrier lowering coefficient	—	0.0086
PDIBLCB	Body-effect on drain-induced barrier lowering	—	0
PDITS	Coefficient for drain-induced Vth shifts	—	1e-20
PDITSD	Vds dependence of drain-induced Vth shifts	—	0
PDITSL	Length dependence of drain-induced Vth shifts	—	0
PDK2B	Cross-term dependence of dk2b	—	0
PDROUT	Cross-term dependence of drout	—	0
PDSUB	Cross-term dependence of dsub	—	0
PDVBD0	Cross-term dependence of dvbd0	—	0
PDVBD1	Cross-term dependence of dvbd1	—	0
PDVT0	Cross-term dependence of dvt0	—	0
PDVT0W	Cross-term dependence of dvt0w	—	0
PDVT1	Cross-term dependence of dvt1	—	0
PDVT1W	Cross-term dependence of dvt1w	—	0

Table 2-109. BSIM-SOI 4.6.1 Device Model Parameters

Parameter	Description	Units	Default
PDVT2	Cross-term dependence of dvt2	—	0
PDVT2W	Cross-term dependence of dvt2w	—	0
PDVTP0	Cross-term dependence of dvtp0	—	0
PDVTP1	Cross-term dependence of dvtp1	—	0
PDVTP2	Cross-term dependence of dvtp2	—	0
PDVTP3	Cross-term dependence of dvtp3	—	0
PDVTP4	Cross-term dependence of dvtp4	—	0
PDWB	Cross-term dependence of dwb	—	0
PDWG	Cross-term dependence of dwg	—	0
PEBJTII	Cross-term dependence of ebjtii	—	0
PEGIDL	Cross-term dependence of egidl	—	0
PEGISL	Cross-term dependence of egisl	—	0
PESATII	Cross-term dependence of esatii	—	0
PETA0	Cross-term dependence of eta0	—	0
PETA0CV	Cross-term dependence of eta0cv	—	0
PETAB	Cross-term dependence of etab	—	0
PETABCV	Cross-term dependence of etabcv	—	0
PEU	Cross-term dependence of eu	—	0
PFBJTII	Cross-term dependence of fbjtii	—	0
PGIDL	Cross-term dependence of fgidl	—	0
PGISL	Cross-term dependence of fgisl	—	0
PFPROUT	Cross-term dependence of pdiblecb	—	0
PHIG	Work function of gate	—	4.05
PIDBJT	Cross-term dependence of idbjt	—	0
PIDDIF	Cross-term dependence of iddif	—	0
PIDREC	Cross-term dependence of idrec	—	0
PIDTUN	Cross-term dependence of idtun	—	0
PIGCD	Parameter for Igc partition	—	1
PISBJT	Cross-term dependence of isbjt	—	0
PISDIF	Cross-term dependence of isdif	—	0
PISREC	Cross-term dependence of isrec	—	0
PISTUN	Cross-term dependence of istun	—	0
PK1	Cross-term dependence of k1	—	0
PK1B	Cross-term dependence of k1b	—	0
PK1W1	Cross-term dependence of k1w1	—	0
PK1W2	Cross-term dependence of k1w2	—	0

Table 2-109. BSIM-SOI 4.6.1 Device Model Parameters

Parameter	Description	Units	Default
PK2	Cross-term dependence of k2	—	0
PK2B	Cross-term dependence of k2b	—	0
PK3	Cross-term dependence of k3	—	0
PK3B	Cross-term dependence of k3b	—	0
PKB1	Cross-term dependence of kb1	—	0
PKETA	Cross-term dependence of keta	—	0
PKETAS	Cross-term dependence of ketas	—	0
PKGIDL	Cross-term dependence of kgidl	—	0
PKGISL	Cross-term dependence of kgisl	—	0
PKT1	Cross-term dependence of kt1	—	0
PKT1L	Cross-term dependence of kt1l	—	0
PKT2	Cross-term dependence of kt2	—	0
PKU0	Cross-term dependence of ku0	—	0
PKVTH0	Cross-term dependence of kvth0	—	0
PLBJT0	Cross-term dependence of lbjt0	—	0
PLII	Cross-term dependence of lii	—	0
PLPE0	Cross-term dependence of lpe0	—	0
PLPEB	Cross-term dependence of lpeb	—	0
PMBJTII	Cross-term dependence of mbjtii	—	0
PMINV	Cross-term dependence of minv	—	0
PMINVCV	Cross-term dependence of minvcv	—	0
PMOIN	Cross-term dependence of moin	—	0
PMOINFD	Cross-term dependence of moinfd	—	0
PNBJT	Cross-term dependence of nbjt	—	0
PNCH	Cross-term dependence of nch	—	0
PNDIF	Cross-term dependence of ndif	—	0
PNDIODE	Cross-term dependence of ndiode	—	0
PNDIODED	Cross-term dependence of ndiode	—	0
PNFACTOR	Cross-term dependence of nfactor	—	0
PNGATE	Cross-term dependence of ngate	—	0
PNGIDL	Cross-term dependence of ngidl	—	0
PNIGC	Cross-term dependence of nigc	—	0
PNLX	Cross-term dependence of nlx	—	0
PNOFF	Cross-term dependence of noff /* v3.2	—	0
PNOFF2	Cross-term dependence of noff2 /* v4.6	—	0
PNOFFFD	Cross-term dependence of nofffd	—	0

Table 2-109. BSIM-SOI 4.6.1 Device Model Parameters

Parameter	Description	Units	Default
PNRECF0	Cross-term dependence of nrecf0	—	0
PNRECF0D	Cross-term dependence of nrecf0	—	0
PNRECR0	Cross-term dependence of nrecr0	—	0
PNRECR0D	Cross-term dependence of nrecr0	—	0
PNSD	Cross-term dependence of nsd	—	0
PNSUB	Cross-term dependence of nsub	—	0
PNTRECF	Cross-term dependence of ntrecf	—	0
PNTRECR	Cross-term dependence of ntreocr	—	0
PNTUN	Cross-term dependence of ntun	—	0
PNTUND	Cross-term dependence of ntund	—	0
POXEDGE	Factor for the gate edge T_{ox}	—	1
PPCLM	Cross-term dependence of pclm	—	0
PPDIBLC1	Cross-term dependence of pdiblc1	—	0
PPDIBLC2	Cross-term dependence of pdiblc2	—	0
PPDIBLCB	Cross-term dependence of pdiblc b	—	0
PPDITS	Cross-term dependence of pdits	—	0
PPDITSD	Cross-term dependence of pditsd	—	0
PPIGCD	Cross-term dependence for pigcd	—	0
PPOXEDGE	Cross-term dependence for poxedge	—	0
PPRT	Cross-term dependence of prt	—	0
PPRWB	Cross-term dependence of prwb	—	0
PPRWG	Cross-term dependence of prwg	—	0
PPVAG	Cross-term dependence of pvag	—	0
PRDSW	Cross-term dependence of rdsw	—	0
PRDW	Cross-term dependence of rdw /*v4.0	—	0
PRGIDL	Cross-term dependence of rgidl	—	0
PRGISL	Cross-term dependence of rgisl	—	0
PRSW	Cross-term dependence of rsw /*v4.0	—	0
PRT	Temperature coefficient of parasitic resistance	—	0
PRWB	Body-effect on parasitic resistance	—	0
PRWG	Gate-bias effect on parasitic resistance	—	0
PS	Source perimeter	m	0
PSBCP	Perimeter length for bc parasitics at source side	m	0
PSII0	Cross-term dependence of sii0	—	0
PSII1	Cross-term dependence of sii1	—	0
PSII2	Cross-term dependence of sii2	—	0

Table 2-109. BSIM-SOI 4.6.1 Device Model Parameters

Parameter	Description	Units	Default
PSIID	Cross-term dependence of siid	—	0
PU0	Cross-term dependence of u0	—	0
PUA	Cross-term dependence of ua	—	0
PUA1	Cross-term dependence of ua1	—	0
PUB	Cross-term dependence of ub	—	0
PUB1	Cross-term dependence of ub1	—	0
PUC	Cross-term dependence of uc	—	0
PUC1	Cross-term dependence of uc1	—	0
PUCS	Cross-term dependence of ucs	—	0
PUCSTE	Cross-term dependence of ucste	—	0
PUD	Cross-term dependence of ud	—	0
PUD1	Cross-term dependence of ud1	—	0
PUTE	Cross-term dependence of ute	—	0
PVABJT	Cross-term dependence of vabjt	—	0
PVAG	Gate dependence of output resistance parameter	—	0
PVBCI	Cross-term dependence of vbci	—	0
PVBS0FD	Cross-term dependence of vbs0fd	—	0
PVBS0PD	Cross-term dependence of vbs0pd	—	0
PVBSA	Cross-term dependence of vbsa	—	0
PVDSATII0	Cross-term dependence of vdsatii0	—	0
PVFB	Cross-term dependence of vfb /* v4.1	—	0
PVOFF	Cross-term dependence of voff	—	0
PVOFFCV	Cross-term dependence of voffcv	—	0
PVOFFFD	Cross-term dependence of vofffd	—	0
PVREC0	Cross-term dependence of vrec0	—	0
PVREC0D	Cross-term dependence of vrec0d	—	0
PVSAT	Cross-term dependence of vsat	—	0
PVSCE	Cross-term dependence of vsce	—	0
PVSDFB	Cross-term dependence of vsdfb	—	0
PVSDTH	Cross-term dependence of vsdth	—	0
PVTH0	Cross-term dependence of vto	—	0
PVTUN0	Cross-term dependence of vtun0	—	0
PVTUN0D	Cross-term dependence of vtun0d	—	0
PW0	Cross-term dependence of w0	—	0
PWR	Cross-term dependence of wr	—	0
PXBJT	Cross-term dependence of xbjt	—	0

Table 2-109. BSIM-SOI 4.6.1 Device Model Parameters

Parameter	Description	Units	Default
PXDIF	Cross-term dependence of xdif	—	0
PXDIFD	Cross-term dependence of xdifd	—	0
PXJ	Cross-term dependence of xj	—	0
PXRCRG1	Cross-term dependence of xrcrg1	—	0
PXRCRG2	Cross-term dependence of xrcrg2	—	0
PXREC	Cross-term dependence of xrec	—	0
PXRECD	Cross-term dependence of xrecd	—	0
PXTUN	Cross-term dependence of xtun	—	0
PXTUND	Cross-term dependence of xtund	—	0
RBDB	Body resistance	—	50
RBODY	Intrinsic body contact sheet resistance	—	0
RBODYMOD	Body R model selector /* v4.0	—	0
RBSB	Body resistance	—	50
RBSH	Extrinsic body contact sheet resistance	—	0
RDSMOD	Bias-dependent S/D resistance model selector /* v4.0	—	0
RDSW	Source-drain resistance per width	—	100
RDW	Drain resistance per width /* v4.0	—	50
RDWMIN	Drain resistance per width at high Vg	—	0
RGATEMOD	Gate resistance model selector	—	0
RGIDL	GIDL vg parameter	—	1
RGISL	GISL vg parameter	—	0
RHALO	body halo sheet resistance	—	1e+15
RNOIA	Thermal noise coefficient	—	0.577
RNOIB	Thermal noise coefficient	—	0.37
RSH	Source-drain sheet resistance	—	0
RSHG	Gate sheet resistance	—	0.1
RSW	Source resistance per width /* v4.0	—	50
RSWMIN	Source resistance per width at high Vg	—	0
RTH0	Instance Thermal Resistance	—	0
SA	distance between OD edge to poly of one side	m	0
SAREF	Reference distance between OD edge to poly of one side	m	1e-06
SB	distance between OD edge to poly of the other side	m	0
SBREF	Reference distance between OD edge to poly of the other side	m	1e-06
SD	distance between neighbor fingers	m	0

Table 2-109. BSIM-SOI 4.6.1 Device Model Parameters

Parameter	Description	Units	Default
SHMOD	Self heating mode selector	—	0
SII0	First Vgs dependent parameter for impact ionization current	—	0.5
SII1	Second Vgs dependent parameter for impact ionization current	—	0.1
SII2	Third Vgs dependent parameter for impact ionization current	—	0
SIID	Vds dependent parameter of drain saturation voltage for impact ionization current	—	0
SOIMOD	Instance model selector for PD/FD operation /* v3.2	—	0
STETA0	eta0 shift factor related to stress effect on vth	m	0
STETA0CV	eta0cv shift factor related to stress effect on vth	—	0
STK2	K2 shift factor related to stress effect on vth	m	0
TBGASUB	First parameter of band-gap change due to temperature	—	0.000702
TBGBSUB	Second parameter of band-gap change due to temperature	—	1108
TBOX	Back gate oxide thickness in meters	m	3e-07
TCJSWG	Temperature coefficient of Cjswgs	1/K	0
TCJSWGD	Temperature coefficient of Cjswgd	1/K	0
TEMPEOT	Temperature for extraction of EOT	K	300.15
TII	Temperature dependent parameter for impact ionization	—	0
TKU0	Temperature coefficient of KU0	—	0
TNOIA	Thermal noise parameter	—	1.5
TNOIB	Thermal noise parameter	—	3.5
TNOIMOD	Thermal noise model selector	—	0
TNOM	Parameter measurement temperature	—	27
TOX	Gate oxide thickness in meters	m	1e-08
TOXM	Gate oxide thickness used in extraction /* v3.2	m	0
TOXP	Physical gate oxide thickness	m	0
TOXQM	effective oxide thickness considering quantum effect	m	0
TOXREF	target oxide thickness	m	2.5e-09
TPBSWG	Temperature coefficient of Pbswgs	V/K	0
TPBSWGD	Temperature coefficient of Pbswgd	V/K	0
TSI	Silicon-on-insulator thickness in meters	m	1e-07
TT	Diffusion capacitance transit time coefficient	s	1e-12
TVBCI	Temperature coefficient for VBCI	—	0
TYPE	+1 = NMOS, -1 = PMOS	—	1

Table 2-109. BSIM-SOI 4.6.1 Device Model Parameters

Parameter	Description	Units	Default
U0	Low-field mobility at Tnom	—	0
UA	Linear gate dependence of mobility	—	2.25e-09
UA1	Temperature coefficient of ua	m/V	4.31e-09
UB	Quadratic gate dependence of mobility	—	5.87e-19
UB1	Temperature coefficient of ub	—	-7.61e-18
UC	Body-bias dependence of mobility	—	0
UC1	Temperature coefficient of uc	—	0
UCS	Mobility exponent	—	0
UCSTE	Temperature coefficient of UCS	—	-0.004775
UD	Coulomb scattering factor of mobility	—	0
UD1	Temperature coefficient of ud	—	0
UTE	Temperature coefficient of mobility	—	-1.5
VABJT	Early voltage for bipolar current	V	10
VBCI	Internal B-C built-in potential	V	0
VBM	Maximum body voltage	V	-3
VBS0FD	Lower bound of built-in potential lowering for FD operation /* v3.2	V	0.5
VBS0PD	Upper bound of built-in potential lowering for PD operation /* v3.2	V	0
VBSA	vbsa offset voltage	V	0
VBSUSR	Vbs specified by user	V	0
VBX	Vth transition body Voltage	—	0
VDDEOT	Voltage for extraction of EOT	—	0
VDSATII0	Nominal drain saturation voltage at threshold for impact ionization current	—	0.9
VECB	Vaux parameter for conduction-band electron tunneling	—	0.026
VERSION	parameter for model version	—	4.6
VEVB	Vaux parameter for valence-band electron tunneling	—	0.075
VFB	Flat Band Voltage /* v4.1	V	-1
VGB1	Third Vox dependent parameter for gate current in inversion	V	300
VGB2	Third Vox dependent parameter for gate current in accumulation	V	17
VGSTCVMOD	Improved VgsteffCV selector	—	0
VOFF	Threshold voltage offset	V	-0.08
VOFFCV	CV Threshold voltage offset // NOT -0.08 for backwards-compatibility	V	0

Table 2-109. BSIM-SOI 4.6.1 Device Model Parameters

Parameter	Description	Units	Default
VOFFFD	smoothing parameter in FD module	V	0
VOXH	the limit of Vox in gate current calculation	V	5
VREC0	Voltage dependent parameter for recombination current	V	0
VREC0D	Voltage dependent parameter for recombination current	V	0
VSAT	Saturation velocity at tnom	—	80000
VSCE	SCE parameter for improved dVbi model	—	0
VSDFB	Source/drain bottom diffusion capacitance flatband voltage	V	0
VSDTH	Source/drain bottom diffusion capacitance threshold voltage	V	0
VTH0	Threshold voltage	V	0
VTHO	Threshold voltage	V	0
VTM00	Hard coded 25 degC thermal voltage	V	0.026
VTUN0	Voltage dependent parameter for tunneling current	V	0
VTUN0D	Voltage dependent parameter for tunneling current	V	0
W	Width	m	5e-06
W0	Narrow width effect parameter	m	2.5e-06
W0FLK	Flicker noise width dependence	—	1e-05
WA0	Width dependence of a0	—	0
WA1	Width dependence of a1	—	0
WA2	Width dependence of a2	—	0
WABJTII	Width dependence of abjtii	—	0
WACDE	Width dependence of acde	—	0
WAELY	Width dependence of aely	—	0
WAGIDL	Width dependence of agidl	—	0
WAGISL	Width dependence of agisl	—	0
WAGS	Width dependence of ags	—	0
WAHLI	Width dependence of ahli /* v4.0	—	0
WAHLID	Width dependence of ahlid /* v4.0	—	0
WAIGBCP2	Width dependence of aigbcp2	—	0
WAIGC	Width dependence of aigc	—	0
WAIGSD	Width dependence of aigsd	—	0
WALPHA0	Width dependence of alpha0	—	0
WALPHAGB1	Width dependence of alphagb1	—	0
WALPHAGB2	Width dependence of alphagb2	—	0

Table 2-109. BSIM-SOI 4.6.1 Device Model Parameters

Parameter	Description	Units	Default
WAT	Width dependence of at	—	0
WB0	Width dependence of b0	—	0
WB1	Width dependence of b1	—	0
WBETA0	Width dependence of beta0	—	0
WBETA1	Width dependence of beta1	—	0
WBETA2	Width dependence of beta2	—	0
WBETAGB1	Width dependence of betagb1	—	0
WBETAGB2	Width dependence of betagb2	—	0
WBGIDL	Width dependence of bgidl	—	0
WBGISL	Width dependence of bgisl	—	0
WBIGBCP2	Width dependence of bigbcp2	—	0
WBIGC	Width dependence of bigc	—	0
WBIGSD	Width dependence of bigsd	—	0
WCBJTII	Width dependence of cbjtii	—	0
WCDSBS	Width dependence of cdsbs	—	0
WCDS	Width dependence of cdsc	—	0
WCDSB	Width dependence of cdsb	—	0
WCSD	Width dependence of cdsd	—	0
WGD	Width dependence of cgd	—	0
WGD	Width dependence of cgdl	—	0
WGD	Width dependence of cgisl	—	0
WGD	Width dependence of cgsl	—	0
WGD	Width dependence of cigbcp2	—	0
WGD	Width dependence of cigc	—	0
WGD	Width dependence of cigsd	—	0
WCIT	Width dependence of cit	—	0
WCKAPPA	Width dependence of ckappa	—	0
WDELTA	Width dependence of delta	—	0
WDELVT	Width dependence of delvt	—	0
WDK2B	Width dependence of dk2b	—	0
WDROUT	Width dependence of drout	—	0
WDSUB	Width dependence of dsub	—	0
WDVBD0	Width dependence of dvbd0	—	0
WDVBD1	Width dependence of dvbd1	—	0
WDVT0	Width dependence of dvt0	—	0
WDVT0W	Width dependence of dvt0w	—	0

Table 2-109. BSIM-SOI 4.6.1 Device Model Parameters

Parameter	Description	Units	Default
WDVT1	Width dependence of dvt1	—	0
WDVT1W	Width dependence of dvt1w	—	0
WDVT2	Width dependence of dvt2	—	0
WDVT2W	Width dependence of dvt2w	—	0
WDVTP0	Width dependence of dvtp0	—	0
WDVTP1	Width dependence of dvtp1	—	0
WDVTP2	Width dependence of dvtp2	—	0
WDVTP3	Width dependence of dvtp3	—	0
WDVTP4	Width dependence of dvtp4	—	0
WDWB	Width dependence of dwb	—	0
WDWG	Width dependence of dwg	—	0
WEBJTII	Width dependence of ebjtii	—	0
WEFFEOT	Effective width for extraction of EOT	—	10
WEGIDL	Width dependence of egidl	—	0
WEGISL	Width dependence of egisl	—	0
WESATII	Width dependence of esatii	—	0
WETA0	Width dependence of eta0	—	0
WETA0CV	Width dependence of eta0cv	—	0
WETAB	Width dependence of etab	—	0
WETABCV	Width dependence of etabcv	—	0
WEU	Width dependence of eu	—	0
WFBJTII	Width dependence of fbjtii	—	0
WFGIDL	Width dependence of fgidl	—	0
WFGISL	Width dependence of fgisl	—	0
WFPROUT	Width dependence of pdiblcb	—	0
WIDBJT	Width dependence of idbjt	—	0
WIDDIF	Width dependence of iddif	—	0
WIDREC	Width dependence of idrec	—	0
WIDTUN	Width dependence of idtun	—	0
WINT	Width reduction parameter	m	0
WISBJT	Width dependence of isbjt	—	0
WISDIF	Width dependence of isdif	—	0
WISREC	Width dependence of isrec	—	0
WISTUN	Width dependence of istun	—	0
WK1	Width dependence of k1	—	0
WK1B	Width dependence of k1b	—	0

Table 2-109. BSIM-SOI 4.6.1 Device Model Parameters

Parameter	Description	Units	Default
WK1W1	Width dependence of k1w1	—	0
WK1W2	Width dependence of k1w2	—	0
WK2	Width dependence of k2	—	0
WK2B	Width dependence of k2b	—	0
WK3	Width dependence of k3	—	0
WK3B	Width dependence of k3b	—	0
WKB1	Width dependence of kb1	—	0
WKETA	Width dependence of keta	—	0
WKETAS	Width dependence of ketas	—	0
WKGIDL	Width dependence of kgidl	—	0
WKGISL	Width dependence of kgisl	—	0
WKT1	Width dependence of kt1	—	0
WKT1L	Width dependence of kt1l	—	0
WKT2	Width dependence of kt2	—	0
WKU0	Width dependence of ku0	—	0
WKVTH0	Width dependence of kvth0	—	0
WL	Width reduction parameter	m	0
WLBJT0	Width dependence of lbjt0	—	0
WLC	Width reduction parameter /* v2.2.3	—	0
WLII	Width dependence of lii	—	0
WLN	Width reduction parameter	—	1
WLOD	Width parameter for stress effect	m	0
WLODKU0	Width parameter for u0 LOD effect	—	0
WLODVTH	Width parameter for vth LOD effect	—	0
WLPE0	Width dependence of lpe0	—	0
WLPEB	Width dependence of lpeb	—	0
WMBJTII	Width dependence of mbjtii	—	0
WMINV	width dependence of minv	—	0
WMINVCV	width dependence of minvcv	—	0
WMOIN	Width dependence of moin	—	0
WMOINFD	Width dependence of moinfd	—	0
WNBjt	Width dependence of nbjt	—	0
WNCH	Width dependence of nch	—	0
WNDIF	Width dependence of ndif	—	0
WNDIODE	Width dependence of ndiode	—	0
WNDIODED	Width dependence of ndioded	—	0

Table 2-109. BSIM-SOI 4.6.1 Device Model Parameters

Parameter	Description	Units	Default
WNFACTOR	Width dependence of nfactor	—	0
WNGATE	Width dependence of ngate	—	0
WNGIDL	Width dependence of ngidl	—	0
WNIGC	Width dependence of nige	—	0
WNLX	Width dependence of nlx	—	0
WNOFF	Width dependence of noff /* v3.2	—	0
WNOFF2	Width dependence of noff2 /* v4.6	—	0
WNOFFFD	Width dependence of nofffd	—	0
WNRECF0	Width dependence of nrecf0	—	0
WNRECF0D	Width dependence of nrecf0d	—	0
WNRECR0	Width dependence of nrecr0	—	0
WNRECR0D	Width dependence of nrecr0d	—	0
WNSD	Width dependence of nsd	—	0
WNSUB	Width dependence of nsub	—	0
WNTRECF	Width dependence of ntrecf	—	0
WNTRECR	Width dependence of ntrecr	—	0
WNTUN	Width dependence of ntun	—	0
WNTUND	Width dependence of ntund	—	0
WPCLM	Width dependence of pclm	—	0
WPDIBLC1	Width dependence of pdiblc1	—	0
WPDIBLC2	Width dependence of pdiblc2	—	0
WPDIBLCB	Width dependence of pdiblcb	—	0
WPDITS	Width dependence of pdits	—	0
WPDITSD	Width dependence of pditsd	—	0
WPIGCD	Width dependence for pigcd	—	0
WPOXEDGE	Width dependence for poxedge	—	0
WPRT	Width dependence of prt	—	0
WPRWB	Width dependence of prwb	—	0
WPRWG	Width dependence of prwg	—	0
WPVAG	Width dependence of pvag	—	0
WR	Width dependence of rds	—	1
WRDSW	Width dependence of rdsw	—	0
WRDW	Width dependence of rdw /* v4.0	—	0
WRGIDL	Width dependence of rgidl	—	0
WRGISL	Width dependence of rgisl	—	0
WRSW	Width dependence of rsw /* v4.0	—	0

Table 2-109. BSIM-SOI 4.6.1 Device Model Parameters

Parameter	Description	Units	Default
WSII0	Width dependence of sii0	—	0
WSII1	Width dependence of sii1	—	0
WSII2	Width dependence of sii2	—	0
WSIID	Width dependence of siid	—	0
WTH0	Minimum width for thermal resistance calculation	m	0
WU0	Width dependence of u0	—	0
WUA	Width dependence of ua	—	0
WUA1	Width dependence of ua1	—	0
WUB	Width dependence of ub	—	0
WUB1	Width dependence of ub1	—	0
WUC	Width dependence of uc	—	0
WUC1	Width dependence of uc1	—	0
WUCS	Width dependence of ucs	—	0
WUCSTE	Width dependence of ucste	—	0
WUD	Width dependence of ud	—	0
WUD1	Width dependence of ud1	—	0
WUTE	Width dependence of ute	—	0
WVABJT	Width dependence of vabjt	—	0
WVBCI	Width dependence of vbci	—	0
WVBS0FD	Width dependence of vbs0fd	—	0
WVBS0PD	Width dependence of vbs0pd	—	0
WVBSA	Width dependence of vbsa	—	0
WVDSATII0	Width dependence of vdsatii0	—	0
WVFB	Width dependence of vfb /* v4.1	—	0
WVOFF	Width dependence of voff	—	0
WVOFFCV	Width dependence of voffcv	—	0
WVOFFFD	Width dependence of vofffd	—	0
WVREC0	Width dependence of vrec0	—	0
WVREC0D	Width dependence of vrec0d	—	0
WVSAT	Width dependence of vsat	—	0
WVSCE	Width dependence of vsce	—	0
WVSDFB	Width dependence of vsdfb	—	0
WVSDTH	Width dependence of vsdth	—	0
WVTH0	Width dependence of vto	—	0
WVTUN0	Width dependence of vtun0	—	0
WVTUN0D	Width dependence of vtun0d	—	0

Table 2-109. BSIM-SOI 4.6.1 Device Model Parameters

Parameter	Description	Units	Default
WW	Width reduction parameter	m	0
WW0	Width dependence of w0	—	0
WWC	Width reduction parameter /* v2.2.3	—	0
WWL	Width reduction parameter	m	0
WWLC	Width reduction parameter /* v2.2.3	—	0
WWN	Width reduction parameter	—	1
WWR	Width dependence of wr	—	0
WXBJT	Width dependence of xbjt	—	0
WXDIF	Width dependence of xdif	—	0
WXDIFD	Width dependence of xdifd	—	0
WXJ	Width dependence of xj	—	0
WXRCRG1	Width dependence of xrcrg1	—	0
WXRCRG2	Width dependence of xrcrg2	—	0
WXREC	Width dependence of xrec	—	0
WXRECD	Width dependence of xrecd	—	0
WXTUN	Width dependence of xtun	—	0
WXTUND	Width dependence of xtund	—	0
XBJT	Temperature coefficient for Isbjt	—	1
XDIF	Temperature coefficient for Isdif	—	0
XDIFD	Temperature coefficient for Iddif	—	0
XGL	Variation in Ldrawn	m	0
XGW	Distance from gate contact center to device edge	m	0
XJ	Junction Depth	m	0
XPART	Channel charge partitioning	—	0
XRCRG1	First fitting parameter the bias-dependent Rg	—	12
XRCRG2	Second fitting parameter the bias-dependent Rg	—	1
XREC	Temperature coefficient for Isrec	—	1
XRECD	Temperature coefficient for Idrec	—	0
XT	Doping depth	m	1.55e-07
XTUN	Temperature coefficient for Istun	—	0
XTUND	Temperature coefficient for Idtun	—	0

Table 2-110. MOSFET level 70 Output Variables

Parameter	Description	Units	Default
VDSAT		V	none

Table 2-110. MOSFET level 70 Output Variables

Parameter	Description	Units	Default
VTH	Threshold Voltage	V	none
IDS	Drain-Source current	A	none
GM		mho	none
GDS		mho	none
GMBS		mho	none
IC	Collector Current	A	none
IBD		A	none
IBS		A	none
IGIDL		A	none
IGISL		A	none
IGS		A	none
IGD		A	none
IGB		A	none
IGCS		A	none
IGCD		A	none
CGG	g-g MOSFET capacitance	F	none
CGS	g-s MOSFET capacitance	F	none
CGD	g-d MOSFET capacitance	F	none
CBG	b-g MOSFET capacitance	F	none
CBS	b-s MOSFET capacitance	F	none
CBD	b-d MOSFET capacitance	F	none
CDG	d-g MOSFET capacitance	F	none
CDD	d-d MOSFET capacitance	F	none
CDS	d-s MOSFET capacitance	F	none
CAPBD	MOSFET capacitance	F	none
CAPBS	MOSFET capacitance	F	none
QG	Gate Charge	C	none
QB	Body Charge	C	none
QD	Drain Charge	C	none
QS	Source Charge	C	none
QJD	Drain Junction Charge	C	none
QJS	Source Junction Charge	C	none
T_TOTAL_K		K	none
T_TOTAL_C		K	none
T_DELTA_SH		K	none

Table 2-111. BSIM-SOI 4.5.0 Device Instance Parameters

Parameter	Description	Units	Default
AD		–	0
AEBCP		–	0
AGBCP		–	0
AGBCP2		–	0
AGBCPD		–	0
AS		–	0
BJTOFF		–	0
CTH0		–	1e-05
DELVTO		–	0
DTEMP		–	0
FRBODY		–	1
L		–	5e-06
M	multiplicity factor	–	1
NBC		–	0
NF		–	1
NRB		–	1
NRD		–	1
NRS		–	1
NSEG		–	1
OFF		–	0
PD		–	0
PDBCP		–	0
PS		–	0
PSBCP		–	0
RBDB		–	50
RBSB		–	50
RTH0		–	0
SA		–	0
SB		–	0
SD		–	0
SHMOD		–	0
SOIMOD		–	0
TNODEOUT		–	0
W		–	5e-06

Table 2-112. BSIM-SOI 4.5.0 Device Model Parameters

Parameter	Description	Units	Default
A0		–	1
A1		–	0
A2		–	1
ABJTII		–	0
ACDE		–	1
AD		–	0
ADOS		–	1
AEBCP		–	0
AELY		–	0
AF		–	1
AGB1		–	3.7622e-07
AGB2		–	4.9758e-07
AGBC2N		–	3.4254e-07
AGBC2P		–	4.9723e-07
AGBCP		–	0
AGBCP2		–	0
AGBCPD		–	0
AGIDL		–	0
AGISL		–	0
AGS		–	0
AHLI		–	0
AHLID		–	0
AIGBCP2		–	0.043
AIGC		–	0
AIGSD		–	0
ALPHA0		–	0
ALPHAGB1		–	0.35
ALPHAGB2		–	0.43
AS		–	0
ASD		–	0.3
AT		–	33000
B0		–	0
B1		–	0
BDOS		–	1
BETA0		–	0
BETA1		–	0

Table 2-112. BSIM-SOI 4.5.0 Device Model Parameters

Parameter	Description	Units	Default
BETA2		–	0.1
BETAGB1		–	0.03
BETAGB2		–	0.05
BF		–	2
BG0SUB		–	1.16
BGB1		–	-3.1051e+10
BGB2		–	-2.357e+10
BGBC2N		–	1.1665e+12
BGBC2P		–	7.4567e+11
BGIDL		–	2.3e+09
BGISL		–	0
BIGBCP2		–	0.0054
BIGC		–	0
BIGSD		–	0
BINUNIT		–	1
BJTOFF		–	0
CAPMOD		–	2
CBJTII		–	0
CDSBS		–	0
CDSC		–	0.00024
CDSCB		–	0
CDSCD		–	0
CF		–	0
CFRCOEFF		–	1
CGDL		–	0
CGDO		–	0
CGEO		–	0
CGIDL		–	0.5
CGISL		–	0
CGSL		–	0
CGSO		–	0
CIGBCP2		–	0.0075
CIGC		–	0
CIGSD		–	0
CIT		–	0
CJSWG		–	1e-10

Table 2-112. BSIM-SOI 4.5.0 Device Model Parameters

Parameter	Description	Units	Default
CJSWGD		–	0
CKAPPA		–	0.6
CLC		–	1e-08
CLE		–	0
CSDESW		–	0
CSDMIN		–	0
CTH0		–	1e-05
DEBUG		–	0
DELTA		–	0.01
DELTAVOX		–	0.005
DELVT		–	0
DELVTO		–	0
DK2B		–	0
DLBG		–	0
DLC		–	0
DLCB		–	0
DLCIG		–	0
DROUT		–	0.56
DSUB		–	0
DTOXCV		–	0
DVBD0		–	0
DVBD1		–	0
DVT0		–	2.2
DVT0W		–	0
DVT1		–	0.53
DVT1W		–	5.3e+06
DVT2		–	-0.032
DVT2W		–	-0.032
DVTP0		–	0
DVTP1		–	0
DVTP2		–	0
DVTP3		–	0
DVTP4		–	0
DWB		–	0
DWBC		–	0
DWC		–	0

Table 2-112. BSIM-SOI 4.5.0 Device Model Parameters

Parameter	Description	Units	Default
DWG		–	0
EASUB		–	4.05
EBG		–	1.2
EBJTII		–	0
EF		–	1
EGGBCP2		–	1.12
EGGDEP		–	1.12
EGIDL		–	0
EGISL		–	0
EM		–	4.1e+07
EOT		–	1e-08
EPSRGATE		–	11.7
EPSROX		–	3.9
EPSRSUB		–	11.7
ESATII		–	1e+07
ETA0		–	0.08
ETA0CV		–	0
ETAB		–	-0.07
ETABCV		–	0
ETSI		–	1e-07
EU		–	0
FBJTII		–	0
FBODY		–	1
FDMOD		–	0
FGIDL		–	0
FGISL		–	0
FNOIMOD		–	1
FPROUT		–	0
FRBODY		–	1
GAMMA1		–	0
GAMMA2		–	0
GBMIN		–	1e-12
GIDLMOD		–	0
IDBJT		–	0
IDDIF		–	0
IDREC		–	0

Table 2-112. BSIM-SOI 4.5.0 Device Model Parameters

Parameter	Description	Units	Default
IDTUN		–	0
IGBMOD		–	0
IGCMOD		–	0
IGMOD		–	0
IIIMOD		–	0
ISBJT		–	1e-06
ISDIF		–	0
ISREC		–	1e-05
ISTUN		–	0
K1		–	0.53
K1B		–	1
K1W1		–	0
K1W2		–	0
K2		–	-0.0186
K2B		–	0
K3		–	0
K3B		–	0
KB1		–	1
KETA		–	-0.6
KETAS		–	0
KF		–	0
KGIDL		–	0
KGISL		–	0
KT1		–	-0.11
KT1L		–	0
KT2		–	0.022
KU0		–	0
KVSAT		–	0
KVTH0		–	0
L		–	5e-06
LA0		–	0
LA1		–	0
LA2		–	0
LABJTII		–	0
LACDE		–	0
LAELY		–	0

Table 2-112. BSIM-SOI 4.5.0 Device Model Parameters

Parameter	Description	Units	Default
LAGIDL		–	0
LAGISL		–	0
LAGS		–	0
LAHLI		–	0
LAHLID		–	0
LAIGBCP2		–	0
LAIGC		–	0
LAIGSD		–	0
LALPHA0		–	0
LALPHAGB1		–	0
LALPHAGB2		–	0
LAT		–	0
LB0		–	0
LB1		–	0
LBETA0		–	0
LBETA1		–	0
LBETA2		–	0
LBETAGB1		–	0
LBETAGB2		–	0
LBGIDL		–	0
LBGISL		–	0
LBIGBCP2		–	0
LBIGC		–	0
LBIGSD		–	0
LBJT0		–	2e-07
LCBJTII		–	0
LCDS		–	0
LCDSB		–	0
LCDSCD		–	0
LCGDL		–	0
LCGIDL		–	0
LCGISL		–	0
LCGSL		–	0
LCIGBCP2		–	0
LCIGC		–	0
LCIGSD		–	0

Table 2-112. BSIM-SOI 4.5.0 Device Model Parameters

Parameter	Description	Units	Default
LCIT		–	0
LCKAPPA		–	0
LDELTA		–	0
LDELVT		–	0
LDIF0		–	1
LDROUT		–	0
LDSUB		–	0
LDVT0		–	0
LDVT0W		–	0
LDVT1		–	0
LDVT1W		–	0
LDVT2		–	0
LDVT2W		–	0
LDVTP0		–	0
LDVTP1		–	0
LDVTP2		–	0
LDVTP3		–	0
LDVTP4		–	0
LDWB		–	0
LDWG		–	0
LEBJTII		–	0
LEFFEOT		–	1
LEGIDL		–	0
LEGISL		–	0
LESATII		–	0
LETA0		–	0
LETA0CV		–	0
LETAB		–	0
LETABCV		–	0
LEU		–	0
LFBJTII		–	0
LFGIDL		–	0
LFGISL		–	0
LFPROUT		–	0
LIDBJT		–	0
LIDDIF		–	0

Table 2-112. BSIM-SOI 4.5.0 Device Model Parameters

Parameter	Description	Units	Default
LIDREC		–	0
LIDTUN		–	0
LII		–	0
LINT		–	0
LISBJT		–	0
LISDIF		–	0
LISREC		–	0
LISTUN		–	0
LK1		–	0
LK1W1		–	0
LK1W2		–	0
LK2		–	0
LK3		–	0
LK3B		–	0
LKB1		–	0
LKETA		–	0
LKETAS		–	0
LKGIDL		–	0
LKGISL		–	0
LKT1		–	0
LKT1L		–	0
LKT2		–	0
LKU0		–	0
LKVTH0		–	0
LL		–	0
LLBJT0		–	0
LLC		–	0
LLII		–	0
LLN		–	1
LLODKU0		–	0
LLODVTH		–	0
LLPE0		–	0
LLPEB		–	0
LMBJTII		–	0
LMINV		–	0
LMINVCV		–	0

Table 2-112. BSIM-SOI 4.5.0 Device Model Parameters

Parameter	Description	Units	Default
LMOIN		–	0
LN		–	2e-06
LNBJT		–	0
LNCH		–	0
LNDIF		–	0
LNDIODE		–	0
LNDIODED		–	0
LNFACTOR		–	0
LNGATE		–	0
LNGIDL		–	0
LNIGC		–	0
LNLX		–	0
LNOFF		–	0
LNRECF0		–	0
LNRECF0D		–	0
LNRECR0		–	0
LNRECR0D		–	0
LNSD		–	0
LNSUB		–	0
LNTRECF		–	0
LNTRECR		–	0
LNTUN		–	0
LNTUND		–	0
LODETA0		–	1
LODETA0CV		–	0
LODK2		–	1
LPCLM		–	0
LPDIBLC1		–	0
LPDIBLC2		–	0
LPDIBLCB		–	0
LPDITS		–	0
LPDITSD		–	0
LPE0		–	0
LPEB		–	0
LPIGCD		–	0
LPOXEDGE		–	0

Table 2-112. BSIM-SOI 4.5.0 Device Model Parameters

Parameter	Description	Units	Default
LPRT		–	0
LPRWB		–	0
LPRWG		–	0
LPVAG		–	0
LRDSW		–	0
LRDW		–	0
LRGIDL		–	0
LRGISL		–	0
LRSW		–	0
LSII0		–	0
LSII1		–	0
LSII2		–	0
LSIID		–	0
LU0		–	0
LUA		–	0
LUA1		–	0
LUB		–	0
LUB1		–	0
LUC		–	0
LUC1		–	0
LUCS		–	0
LUCSTE		–	0
LUD		–	0
LUD1		–	0
LUTE		–	0
LVABJT		–	0
LVBCI		–	0
LVDSATII0		–	0
LVFB		–	0
LVOFF		–	0
LVOFFCV		–	0
LVREC0		–	0
LVREC0D		–	0
LVSAT		–	0
LVSDFB		–	0
LVSDTH		–	0

Table 2-112. BSIM-SOI 4.5.0 Device Model Parameters

Parameter	Description	Units	Default
LVTH0		–	0
LVTUN0		–	0
LVTUN0D		–	0
LW		–	0
LW0		–	0
LWC		–	0
LWL		–	0
LWLC		–	0
LWN		–	1
LWR		–	0
LXBJT		–	0
LXDIF		–	0
LXDIFD		–	0
LXJ		–	0
LXRCRG1		–	0
LXRCRG2		–	0
LXREC		–	0
LXRECD		–	0
LXTUN		–	0
LXTUND		–	0
MBJTII		–	0.4
MINV		–	0
MINVCV		–	0
MJSWG		–	0.5
MJSWGD		–	0
MOBMOD		–	1
MOIN		–	15
MOINFD		–	1000
MTRLMOD		–	0
NBC		–	0
NBJT		–	1
NCH		–	1.7e+17
NDIF		–	-1
NDIODE		–	1
NDIODED		–	0
NF		–	1

Table 2-112. BSIM-SOI 4.5.0 Device Model Parameters

Parameter	Description	Units	Default
NFACTOR		–	1
NGATE		–	0
NGCON		–	1
NGIDL		–	1.2
NI0SUB		–	1.45e+10
NIGC		–	1
NLX		–	1.74e-07
NOFF		–	1
NOFFFD		–	1
NOIA		–	0
NOIB		–	0
NOIC		–	8.75e+09
NOIF		–	1
NRB		–	1
NRD		–	1
NRECF0		–	2
NRECF0D		–	0
NRECR0		–	10
NRECR0D		–	0
NRS		–	1
NSD		–	1e+20
NSEG		–	1
NSUB		–	6e+16
NTNOI		–	1
NTOX		–	1
NTRECF		–	0
NTRECR		–	0
NTUN		–	10
NTUND		–	0
OFF		–	0
PA0		–	0
PA1		–	0
PA2		–	0
PABJTII		–	0
PACDE		–	0
PAELY		–	0

Table 2-112. BSIM-SOI 4.5.0 Device Model Parameters

Parameter	Description	Units	Default
PAGIDL		–	0
PAGISL		–	0
PAGS		–	0
PAHLI		–	0
PAHLID		–	0
PAIGBCP2		–	0
PAIGC		–	0
PAIGSD		–	0
PALPHA0		–	0
PALPHAGB1		–	0
PALPHAGB2		–	0
PARAMCHK		–	0
PAT		–	0
PB0		–	0
PB1		–	0
PBETA0		–	0
PBETA1		–	0
PBETA2		–	0
PBETAGB1		–	0
PBETAGB2		–	0
PBGIDL		–	0
PBGISL		–	0
PBIGBCP2		–	0
PBIGC		–	0
PBIGSD		–	0
PBSWG		–	0.7
PBSWGD		–	0
PCBJTII		–	0
PCDSC		–	0
PCDSCB		–	0
PCDSCD		–	0
PCGDL		–	0
PCGIDL		–	0
PCGISL		–	0
PCGSL		–	0
PCIGBCP2		–	0

Table 2-112. BSIM-SOI 4.5.0 Device Model Parameters

Parameter	Description	Units	Default
PCIGC		–	0
PCIGSD		–	0
PCIT		–	0
PCKAPPA		–	0
PCLM		–	1.3
PD		–	0
PDBCP		–	0
PDELTA		–	0
PDELVT		–	0
PDIBLC1		–	0.39
PDIBLC2		–	0.0086
PDIBLCB		–	0
PDITS		–	1e-20
PDITSD		–	0
PDITSL		–	0
PDROUT		–	0
PDSUB		–	0
PDVT0		–	0
PDVT0W		–	0
PDVT1		–	0
PDVT1W		–	0
PDVT2		–	0
PDVT2W		–	0
PDVTP0		–	0
PDVTP1		–	0
PDVTP2		–	0
PDVTP3		–	0
PDVTP4		–	0
PDWB		–	0
PDWG		–	0
PEBJTII		–	0
PEGIDL		–	0
PEGISL		–	0
PESATII		–	0
PETA0		–	0
PETA0CV		–	0

Table 2-112. BSIM-SOI 4.5.0 Device Model Parameters

Parameter	Description	Units	Default
PETAB		–	0
PETABCV		–	0
PEU		–	0
PFBJTII		–	0
PFGIDL		–	0
PFGISL		–	0
PFPROUT		–	0
PHIG		–	4.05
PIDBJT		–	0
PIDDIF		–	0
PIDREC		–	0
PIDTUN		–	0
PIGCD		–	1
PISBJT		–	0
PISDIF		–	0
PISREC		–	0
PISTUN		–	0
PK1		–	0
PK1W1		–	0
PK1W2		–	0
PK2		–	0
PK3		–	0
PK3B		–	0
PKB1		–	0
PKETA		–	0
PKETAS		–	0
PKGIDL		–	0
PKGISL		–	0
PKT1		–	0
PKT1L		–	0
PKT2		–	0
PKU0		–	0
PKVTH0		–	0
PLBJT0		–	0
PLII		–	0
PLPE0		–	0

Table 2-112. BSIM-SOI 4.5.0 Device Model Parameters

Parameter	Description	Units	Default
PLPEB		–	0
PMBJTII		–	0
PMINV		–	0
PMINVCV		–	0
PMOIN		–	0
PNBJT		–	0
PNCH		–	0
PNDIF		–	0
PNDIODE		–	0
PNDIODED		–	0
PNFACTOR		–	0
PNGATE		–	0
PNGIDL		–	0
PNIGC		–	0
PNLX		–	0
PNOFF		–	0
PNRECF0		–	0
PNRECF0D		–	0
PNRECR0		–	0
PNRECR0D		–	0
PNSD		–	0
PNSUB		–	0
PNTRECF		–	0
PNTRECR		–	0
PNTUN		–	0
PNTUND		–	0
POXEDGE		–	1
PPCLM		–	0
PPDIBLC1		–	0
PPDIBLC2		–	0
PPDIBLCB		–	0
PPDITS		–	0
PPDITSD		–	0
PPIGCD		–	0
PPOXEDGE		–	0
PPRT		–	0

Table 2-112. BSIM-SOI 4.5.0 Device Model Parameters

Parameter	Description	Units	Default
PPRWB		–	0
PPRWG		–	0
PPVAG		–	0
PRDSW		–	0
PRDW		–	0
PRGIDL		–	0
PRGISL		–	0
PRSW		–	0
PRT		–	0
PRWB		–	0
PRWG		–	0
PS		–	0
PSBCP		–	0
PSII0		–	0
PSII1		–	0
PSII2		–	0
PSIID		–	0
PU0		–	0
PUA		–	0
PUA1		–	0
PUB		–	0
PUB1		–	0
PUC		–	0
PUC1		–	0
PUCS		–	0
PUCSTE		–	0
PUD		–	0
PUD1		–	0
PUTE		–	0
PVABJT		–	0
PVAG		–	0
PVBCI		–	0
PVDSATII0		–	0
PVFB		–	0
PVOFF		–	0
PVOFFCV		–	0

Table 2-112. BSIM-SOI 4.5.0 Device Model Parameters

Parameter	Description	Units	Default
PVREC0		–	0
PVREC0D		–	0
PVSAT		–	0
PVSDFB		–	0
PVSDTH		–	0
PVTH0		–	0
PVTUN0		–	0
PVTUN0D		–	0
PW0		–	0
PWR		–	0
PXBJT		–	0
PXDIF		–	0
PXDIFD		–	0
PXJ		–	0
PXRCRG1		–	0
PXRCRG2		–	0
PXREC		–	0
PXRECD		–	0
PXTUN		–	0
PXTUND		–	0
RBDB		–	50
RBODY		–	0
RBODYMOD		–	0
RBSB		–	50
RBSH		–	0
RDSMOD		–	0
RDSW		–	100
RDW		–	50
RDWMIN		–	0
RGATEMOD		–	0
RGIDL		–	1
RGISL		–	0
RHALO		–	1e+15
RNOIA		–	0.577
RNOIB		–	0.37
RSH		–	0

Table 2-112. BSIM-SOI 4.5.0 Device Model Parameters

Parameter	Description	Units	Default
RSHG		–	0.1
RSW		–	50
RSWMIN		–	0
RTH0		–	0
SA		–	0
SAREF		–	1e-06
SB		–	0
SBREF		–	1e-06
SD		–	0
SHMOD		–	0
SII0		–	0.5
SII1		–	0.1
SII2		–	0
SIID		–	0
SOIMOD		–	0
STETA0		–	0
STETA0CV		–	0
STK2		–	0
TBGASUB		–	0.000702
TBGBSUB		–	1108
TBOX		–	3e-07
TCJSWG		–	0
TCJSWGD		–	0
TEMPEOT		–	300.15
TII		–	0
TKU0		–	0
TNOIA		–	1.5
TNOIB		–	3.5
TNOIMOD		–	0
TNOM		–	27
TOX		–	1e-08
TOXM		–	0
TOXP		–	0
TOXQM		–	0
TOXREF		–	2.5e-09
TPBSWG		–	0

Table 2-112. BSIM-SOI 4.5.0 Device Model Parameters

Parameter	Description	Units	Default
TPBSWGD		–	0
TSI		–	1e-07
TT		–	1e-12
TVBCI		–	0
TYPE		–	1
U0		–	0
UA		–	2.25e-09
UA1		–	4.31e-09
UB		–	5.87e-19
UB1		–	-7.61e-18
UC		–	0
UC1		–	0
UCS		–	0
UCSTE		–	-0.004775
UD		–	0
UD1		–	0
UTE		–	-1.5
VABJT		–	10
VBCI		–	0
VBM		–	-3
VBS0FD		–	0.5
VBS0PD		–	0
VBSA		–	0
VBSUSR		–	0
VBX		–	0
VDDEOT		–	0
VDSATII0		–	0.9
VECB		–	0.026
VERSION		–	4.4
VEVB		–	0.075
VFB		–	-1
VGB1		–	300
VGB2		–	17
VGSTCVMOD		–	0
VOFF		–	-0.08
VOFFCV		–	0

Table 2-112. BSIM-SOI 4.5.0 Device Model Parameters

Parameter	Description	Units	Default
VOFFFD		–	0
VOXH		–	5
VREC0		–	0
VREC0D		–	0
VSAT		–	80000
VSCE		–	0
VSDFB		–	0
VSDTH		–	0
VTH0		–	0
VTHO		–	0
VTM00		–	0.026
VTUN0		–	0
VTUN0D		–	0
W		–	5e-06
W0		–	2.5e-06
W0FLK		–	1e-05
WA0		–	0
WA1		–	0
WA2		–	0
WABJTII		–	0
WACDE		–	0
WAELY		–	0
WAGIDL		–	0
WAGISL		–	0
WAGS		–	0
WAHLI		–	0
WAHLID		–	0
WAIGBCP2		–	0
WAIGC		–	0
WAIGSD		–	0
WALPHA0		–	0
WALPHAGB1		–	0
WALPHAGB2		–	0
WAT		–	0
WB0		–	0
WB1		–	0

Table 2-112. BSIM-SOI 4.5.0 Device Model Parameters

Parameter	Description	Units	Default
WBETA0		–	0
WBETA1		–	0
WBETA2		–	0
WBETAGB1		–	0
WBETAGB2		–	0
WBGIDL		–	0
WBGISL		–	0
WBIGBCP2		–	0
WBIGC		–	0
WBIGSD		–	0
WCBJTII		–	0
WCDSC		–	0
WCDSCB		–	0
WCDSCD		–	0
WCGDL		–	0
WCGIDL		–	0
WCGISL		–	0
WCGSL		–	0
WCIGBCP2		–	0
WCIGC		–	0
WCIGSD		–	0
WCIT		–	0
WCKAPPA		–	0
WDELTA		–	0
WDELVT		–	0
WDROUT		–	0
WDSUB		–	0
WDVT0		–	0
WDVT0W		–	0
WDVT1		–	0
WDVT1W		–	0
WDVT2		–	0
WDVT2W		–	0
WDVTP0		–	0
WDVTP1		–	0
WDVTP2		–	0

Table 2-112. BSIM-SOI 4.5.0 Device Model Parameters

Parameter	Description	Units	Default
WDVTP3		–	0
WDVTP4		–	0
WDWB		–	0
WDWG		–	0
WEBJTII		–	0
WEFFEOT		–	10
WEGIDL		–	0
WEGISL		–	0
WESATII		–	0
WETA0		–	0
WETA0CV		–	0
WETAB		–	0
WETABCV		–	0
WEU		–	0
WFBJTII		–	0
WFGIDL		–	0
WFGISL		–	0
WFPROUT		–	0
WIDBJT		–	0
WIDDIF		–	0
WIDREC		–	0
WIDTUN		–	0
WINT		–	0
WISBJT		–	0
WISDIF		–	0
WISREC		–	0
WISTUN		–	0
WK1		–	0
WK1W1		–	0
WK1W2		–	0
WK2		–	0
WK3		–	0
WK3B		–	0
WKB1		–	0
WKETA		–	0
WKETAS		–	0

Table 2-112. BSIM-SOI 4.5.0 Device Model Parameters

Parameter	Description	Units	Default
WKGIDL		–	0
WKGISL		–	0
WKT1		–	0
WKT1L		–	0
WKT2		–	0
WKU0		–	0
WKVTH0		–	0
WL		–	0
WLBJT0		–	0
WLC		–	0
WLII		–	0
WLN		–	1
WLOD		–	0
WLODKU0		–	0
WLODVTH		–	0
WLPE0		–	0
WLPEB		–	0
WMBJTII		–	0
WMINV		–	0
WMINVCV		–	0
WMOIN		–	0
WNBJT		–	0
WNCH		–	0
WNDIF		–	0
WNDIODE		–	0
WNDIODED		–	0
WNFACTOR		–	0
WNGATE		–	0
WNGIDL		–	0
WNIGC		–	0
WNLX		–	0
WNOFF		–	0
WNRECF0		–	0
WNRECF0D		–	0
WNRECR0		–	0
WNRECR0D		–	0

Table 2-112. BSIM-SOI 4.5.0 Device Model Parameters

Parameter	Description	Units	Default
WNSD		–	0
WNSUB		–	0
WNTRECF		–	0
WNTRECR		–	0
WNTUN		–	0
WNTUND		–	0
WPCLM		–	0
WPDIBLC1		–	0
WPDIBLC2		–	0
WPDIBLCB		–	0
WPDITS		–	0
WPDITS0		–	0
WPIGCD		–	0
WPOXEDGE		–	0
WPRT		–	0
WPRWB		–	0
WPRWG		–	0
WPVAG		–	0
WR		–	1
WRDSW		–	0
WRDW		–	0
WRGIDL		–	0
WRGISL		–	0
WRSW		–	0
WSII0		–	0
WSII1		–	0
WSII2		–	0
WSIID		–	0
WTH0		–	0
WU0		–	0
WUA		–	0
WUA1		–	0
WUB		–	0
WUB1		–	0
WUC		–	0
WUC1		–	0

Table 2-112. BSIM-SOI 4.5.0 Device Model Parameters

Parameter	Description	Units	Default
WUCS		–	0
WUCSTE		–	0
WUD		–	0
WUD1		–	0
WUTE		–	0
WVABJT		–	0
WVBCI		–	0
WVDSATII0		–	0
WVFB		–	0
WVOFF		–	0
WVOFFCV		–	0
WVREC0		–	0
WVREC0D		–	0
WVSAT		–	0
WVSDFB		–	0
WVSDTH		–	0
WVTH0		–	0
WVTUN0		–	0
WVTUN0D		–	0
WW		–	0
WW0		–	0
WWC		–	0
WWL		–	0
WWLC		–	0
WWN		–	1
WWR		–	0
WXBJT		–	0
WXDIF		–	0
WXDIFD		–	0
WXJ		–	0
WXRCRG1		–	0
WXRCRG2		–	0
WXREC		–	0
WXRECD		–	0
WXTUN		–	0
WXTUND		–	0

Table 2-112. BSIM-SOI 4.5.0 Device Model Parameters

Parameter	Description	Units	Default
XBJT		–	1
XDIF		–	0
XDIFD		–	0
XGL		–	0
XGW		–	0
XJ		–	0
XPART		–	0
XRCRG1		–	12
XRCRG2		–	1
XREC		–	1
XRECD		–	0
XT		–	1.55e-07
XTUN		–	0
XTUND		–	0

Table 2-113. MOSFET level 70450 Output Variables

Parameter	Description	Units	Default
VDSAT	VDSAT	–	none
VTH	VTH	–	none
IDS	IDS	–	none
GM	GM	–	none
GDS	GDS	–	none
GMBS	GMBS	–	none
IC	IC	–	none
IBD	IBD	–	none
IBS	IBS	–	none
IGIDL	IGIDL	–	none
IGISL	IGISL	–	none
IGS	IGS	–	none
IGD	IGD	–	none
IGB	IGB	–	none
IGCS	IGCS	–	none
IGCD	IGCD	–	none
CGG	CGG	–	none
CGS	CGS	–	none

Table 2-113. MOSFET level 70450 Output Variables

Parameter	Description	Units	Default
CGD	CGD	–	none
CBG	CBG	–	none
CBD	CBD	–	none
CBS	CBS	–	none
CDG	CDG	–	none
CDD	CDD	–	none
CDS	CDS	–	none
CAPBD	CAPBD	–	none
CAPBS	CAPBS	–	none
QG	QG	–	none
QB	QB	–	none
QD	QD	–	none
QS	QS	–	none
QJD	QJD	–	none
QJS	QJS	–	none

2.3.20.10. Level 77 MOSFET Tables (BSIM6 version 6.1.1)

Xyce includes the BSIM6 MOSFET model, version 6.1.1. Full documentation of the BSIM6 is available at its web site, <http://bsim.berkeley.edu/models/bsim6/>. Instance and model parameters for the BSIM6 are given in tables 2-114 and 2-115. These tables are generated directly from information present in the original Verilog-A implementation of the BSIM6, and lack many descriptions for the parameters. Consult the BSIM6 technical manual from the BSIM group for further details about these parameters.

Beginning with version 7.2 of Xyce, an optional fifth node may be specified for BSIM6 devices. If specified, it is the temperature node, which is used by the self-heating model and is internal if not specified on the instance line.

The BSIM6 device supports output of the internal variables in table 2-116 on the .PRINT line of a netlist. To access them from a print line, use the syntax N(<instance>:<variable>) where “<instance>” refers to the name of the specific level 77 M device in your netlist.

Table 2-114. BSIM6 Device Instance Parameters

Parameter	Description	Units	Default
AD	Drain to Substrate Junction Area	—	0
AS	Source to Substrate Junction Area	—	0
GEOMOD	Geo dependent parasitics model	—	0
L		m	1e-05
M	multiplicity factor	—	1
MINZ	Minimize either D or S	—	0
NF	Number of fingers	—	1
NGCON	Number of gate contacts	—	1
NRD	Number of squares in drain	—	1
NRS	Number of squares in source	—	1
PD	Drain to Substrate Junction Perimeter	—	0
PS	Source to Substrate Junction Perimeter	—	0
RBDB	Resistance between bNode and dbNode	—	50
RBODYMOD	Distributed body R model	—	0
RBPB	Resistance between bNodePrime and bNode	—	50
RBPD	Resistance between bNodePrime and bNode	—	50
RBPS	Resistance between bNodePrime and sbNode	—	50
RBSB	Resistance between bNode and sbNode	—	50
RGATEMOD	Gate resistance model selector	—	0
RGEOMOD	Geometry-dependent source/drain resistance, 0: RSH-based, 1: Holistic	—	0
SA	Distance between OD edge from Poly from one side	—	0
SB	Distance between OD edge from Poly from other side	—	0
SC	Distance to a single well edge if <=0.0, turn off WPE	—	0

Table 2-114. BSIM6 Device Instance Parameters

Parameter	Description	Units	Default
SCA		—	0
SCB		—	0
SCC		—	0
SD	Distance between neighboring fingers	—	0
VFBSDOFF		—	0
W	Total width including fingers	m	1e-05
XGW	Dist from gate contact center to dev edge [m]	m	0

Table 2-115. BSIM6 Device Model Parameters

Parameter	Description	Units	Default
A1	Non-saturation effect parameter for strong inversion region	—	0
A11	Temperature dependence of A1	—	0
A2	Non-saturation effect parameter for moderate inversion region	—	0
A21	Temperature dependence of A2	—	0
ADOS	Quantum mechanical effect prefactor cum switch in inversion	—	0
AGIDL	pre-exponential coeff. for GIDL in mho	—	0
AGIDLL	Length dependence coefficient of AGIDL	—	0
AGIDLW	Width dependence coefficient of AGIDL	—	0
AGISL	pre-exponential coeff. for GISL	—	0
AGISLL	Length dependence coefficient of AGISL	—	0
AGISLW	Width dependence coefficient of AGISL	—	0
AIGBACC	Parameter for Igb	—	0.0136
AIGBINV	Parameter for Igb	—	0.0111
AIGC	Parameter for Igc	—	0
AIGCL	Length dependence coefficient of AIGC	—	0
AIGCW	Width dependence coefficient of AIGC	—	0
AIGD	Parameter for Igs d	—	0
AIGDL	Length dependence coefficient of AIGD	—	0
AIGDW	Width dependence coefficient of AIGD	—	0
AIGS	Parameter for Igs d	—	0
AIGSL	Length dependence coefficient of AIGS	—	0
AIGSW	Width dependence coefficient of AIGS	—	0
ALPHA0	first parameter of Iii, m/V	—	0

Table 2-115. BSIM6 Device Model Parameters

Parameter	Description	Units	Default
ALPHA0L	Length dependence coefficient of ALPHA0	—	0
ALPHA0LEXP	Length dependence exponent coefficient of ALPHA0	—	1
ASYMMOD	0: Asymmetry Model turned off - forward mode parameters used, 1: Asymmetry Model turned on	—	0
AT	Temperature coefficient for saturation velocity	—	-0.00156
ATL	Length Scaling parameter for AT	—	0
BDOS	Charge centroid parameter - slope of CV curve under QME in inversion	—	1
BETA0	Vds dependent parameter of Iii, 1/V	—	0
BG0SUB	Band gap of substrate at 300.15K	—	1.17
BGIDL	exponential coeff. for GIDL in	—	2.3e+09
BGISL	exponential coeff. for GISL	—	0
BIGBACC	Parameter for Igb	—	0.00171
BIGBINV	Parameter for Igb	—	0.000949
BIGC	Parameter for Igc	—	0
BIGD	Parameter for Igs d	—	0
BIGS	Parameter for Igs d	—	0
BINUNIT	Unit of L and W for Binning, 1 : micro-meter, 0 : default	—	1
BVD	Drain diode breakdown voltage	—	0
BVS	Source diode breakdown voltage	—	10
CDSCB	body-bias sensitivity of sub-threshold slope	—	0
CDSCBEDGE		—	0
CDSCBL	Length dependence coefficient of CDSCB	—	0
CDSCBLEXP	Length dependence exponent coefficient of CDSCB	—	1
CDSCD	drain-bias sensitivity of sub-threshold slope	—	1e-09
CDSCDEEDGE		—	0
CDSCDL	Length dependence coefficient of CDSCD	—	0
CDSCDLEXP	Length dependence exponent coefficient of CDSCD	—	1
CDSCDLR	Length dependence coefficient of CDSCD	—	0
CDSCDR	drain-bias sensitivity of sub-threshold slope	—	0
CF	Outer Fringe Cap	F	0
CFRCOEFF	Coefficient for Outer Fringe Cap	—	1
CGBO	Gate - Body overlap capacitance	—	0
CGDL		—	0
CGDO	Gate - Drain overlap capacitance	—	0
CGIDL	exponential coeff. for GIDL in V/m	—	0.5

Table 2-115. BSIM6 Device Model Parameters

Parameter	Description	Units	Default
CGISL	exponential coeff. for GISL	—	0
CGSL		—	0
CGSO	Gate - Source overlap capacitance	—	0
CIGBACC	Parameter for Igb	—	0.075
CIGBINV	Parameter for Igb	—	0.006
CIGC	Parameter for Igc	—	0
CIGD	Parameter for Igs d	—	0
CIGS	Parameter for Igs d	—	0
CIT	parameter for interface trap	—	0
CITEDGE		—	0
CJD	Unit area drain-side junction capacitance at zero bias	—	0
CJS	Unit area source-side junction capacitance at zero bias	—	0.0005
CJSWD	Unit length drain-side sidewall junction capacitance at zero bias	—	0
CJSWGD	Unit length drain-side gate sidewall junction capacitance at zero bias	—	0
CJSWGS	Unit length source-side gate sidewall junction capacitance at zero bias	—	0
CJSWS	Unit length source-side sidewall junction capacitance at zero bias	—	5e-10
CKAPPAD		—	0.6
CKAPPAS		—	0.6
COVMOD	0: Use Bias-independent Overlap Capacitances, 1: Use Bias-dependent Overlap Capacitances	—	0
CTH0	Thermal capacitance	—	1e-05
CVMOD	0: Consistent IV-CV, 1: Different IV-CV	—	0
DELTA	Smoothing function factor for Vdsat	—	0.125
DELTA L	Length dependence coefficient of DELTA	—	0
DELTA L EXP	Length dependence exponent coefficient of DELTA	—	1
DELVT0		—	0
DGAMMAEDGE		—	0
DGAMMAEDGEL		—	0
DGAMMAEDGE L EXP		—	1
DLBIN		—	0
DLC	delta L for CV	—	0
DLCIG	Delta L for I _g model [m]	m	0
DLCIGD	Delta L for I _g model [m]	m	0

Table 2-115. BSIM6 Device Model Parameters

Parameter	Description	Units	Default
DMCG	Distance of Mid-Contact to Gate edge	m	0
DMCGT	Dist of Mid-Contact to Gate edge in Test	m	0
DMCI	Distance of Mid-Contact to Isolation	m	0
DMDG	Distance of Mid-Diffusion to Gate edge	m	0
DSUB	Length scaling exponent for DIBL	—	1
DTEMP	Offset of Device Temperature	—	0
DTOX	Difference between effective dielectric thickness	—	0
DVT0EDGE		—	2.2
DVT1EDGE		—	0.53
DVT2EDGE	Body-bias coefficient for SCE effect for Edge FET	—	0
DVTEDGE	Vth shift for Edge FET	—	0
DVTP0	DITS	—	0
DVTP1	DITS	—	0
DVTP2	DITS	—	0
DVTP3	DITS	—	0
DVTP4	DITS	—	0
DVTP5	DITS	—	0
DWBIN		—	0
DWC	delta W for CV	—	0
DWJ	delta W for S/D junctions	—	0
EASUB	Electron affinity of substrate	—	4.05
EDGEFET	0: Edge FET Model Off, 1: Edge FET Model ON	—	1
EF	Flicker Noise frequency exponent	—	1
EGIDL	band bending parameter for GIDL	—	0.8
EGISL	band bending parameter for GISL	—	0
EIGBINV	Parm for the Si bandgap for Igbinv	—	1.1
EM		—	4.1e+07
EPSROX	Relative dielectric constant of the gate dielectric	—	3.9
EPSRSUB	Relative dielectric constant of the channel material	—	11.9
ETA0	DIBL coefficient	—	0.08
ETA0EDGE		—	0
ETA0R	DIBL coefficient	—	0
ETAB	Body bias coefficient for subthreshold DIBL effect	—	-0.07
ETABEDGE		—	0
ETABEXP	Exponent coefficient of ETAB	—	1
ETAMOB	Effective field parameter (should be kept close to 1)	—	1

Table 2-115. BSIM6 Device Model Parameters

Parameter	Description	Units	Default
ETAQM	Bulk charge coefficient for charge centroid in inversion	—	0.54
EU	Mobility reduction exponent	—	1.5
EUL	Length dependence coefficient of EU	—	0
EULEXP	Length dependence exponent coefficient of EU	—	1
EUW	Width dependence coefficient of EU	—	0
EUWEXP	Width dependence exponent coefficient of EU	—	1
EUWL	Width-Length dependence coefficient of EU	—	0
EUWLEXP	Width-Length dependence coefficient of EU	—	1
FPROUT		—	0
FPROUTL	Length dependence coefficient of FPROUT	—	0
FPROUTLEXP	Length dependence exponent coefficient of FPROUT	—	1
GBMIN	Minimum body conductance	—	1e-12
GEOMOD	Geo dependent parasitics model	—	0
GIDLMOD	0: Turn off GIDL Current, 1: Turn on GIDL Current	—	0
IGBMOD	0: Turn off Igb, 1: Turn on Igb	—	0
IGCMOD	0: Turn off Igc, Igs and Igd, 1: Turn on Igc, Igs and Igd	—	0
IGT	Gate Current Temperature Dependence	—	2.5
IIT	Temperature coefficient for BETA0	—	0
IJTHDFWD	Forward drain diode breakdown limiting current	—	0
IJTHDREV	Reverse drain diode breakdown limiting current	—	0
IJTHSFWD	Forward source diode breakdown limiting current	—	0.1
IJTHSREV	Reverse source diode breakdown limiting current	—	0.1
JSD	Bottom drain junction reverse saturation current density	—	0
JSS	Bottom source junction reverse saturation current density	—	0.0001
JSWD	Unit length reverse saturation current for sidewall drain junction	—	0
JSWGD	Unit length reverse saturation current for gate-edge sidewall drain junction	—	0
JSWGS	Unit length reverse saturation current for gate-edge sidewall source junction	—	0
JSWS	Unit length reverse saturation current for sidewall source junction	—	0
JTSD	Bottom drain junction trap-assisted saturation current density	—	0
JTSS	Bottom source junction trap-assisted saturation current density	—	0

Table 2-115. BSIM6 Device Model Parameters

Parameter	Description	Units	Default
JTSSWD	Unit length trap-assisted saturation current for sidewall drain junction	—	0
JTSSWGD	Unit length trap-assisted saturation current for gate-edge sidewall drain junction	—	0
JTSSWGS	Unit length trap-assisted saturation current for gate-edge sidewall source junction	—	0
JTSSWS	Unit length trap-assisted saturation current for sidewall source junction	—	0
JTWEFF	Trap assisted tunneling current width dependence	—	0
K1	First-order body-bias Vth shift due to Vertical Non-uniform doping	—	0
K1L	Length dependence coefficient of K1	—	0
K1LEXP	Length dependence exponent coefficient of K1	—	1
K1W	Width dependence coefficient of K1	—	0
K1WEXP	Width dependence exponent coefficient of K1	—	1
K1WL	Width-Length dependence coefficient of K1	—	0
K1WLEXP	Width-Length dependence exponent coefficient of K1	—	1
K2	Vth shift due to Vertical Non-uniform doping	—	0
K2L	Length dependence coefficient of K2	—	0
K2LEXP	Length dependence exponent coefficient of K2	—	1
K2W	Width dependence coefficient of K2	—	0
K2WE		—	0
K2WEXP	Width dependence exponent coefficient of K2	—	1
K2WL	Width-Length dependence coefficient of K2	—	0
K2WLEXP	Width-Length dependence exponent coefficient of K2	—	1
KT1	Temperature coefficient for Vth	—	-0.11
KT1EDGE		—	0
KT1EXP	Temperature coefficient for Vth	—	1
KT1EXPEDGE		—	0
KT1L	Temperature coefficient for Vth	—	0
KT1LEDGE		—	0
KT2	Temperature coefficient for Vth	—	0.022
KT2EDGE		—	0
KU0	Mobility degradation/enhancement Parameter for Stress Effect	—	0
KU0WE		—	0
KVSAT	Saturation Velocity degradation/enhancement Parameter for Stress Effect	—	0

Table 2-115. BSIM6 Device Model Parameters

Parameter	Description	Units	Default
KVTH0	Threshold Shift parameter for stress effect	—	0
KVTH0WE		—	0
L		m	1e-05
LA1		—	0
LA11		—	0
LA2		—	0
LA21		—	0
LAGIDL		—	0
LAGISL		—	0
LAIGBACC		—	0
LAIGBINV		—	0
LAIGC		—	0
LAIGD		—	0
LAIGS		—	0
LALPHA0		—	0
LAT		—	0
LBETA0		—	0
LBGIDL		—	0
LBGISL		—	0
LBIGBACC		—	0
LBIGBINV		—	0
LBIGC		—	0
LBIGD		—	0
LBIGS		—	0
LCDSCB		—	0
LCDSCD		—	0
LCDSCLR		—	0
LCF		F	0
LCGDL		—	0
LCGIDL		—	0
LCGISL		—	0
LCGSL		—	0
LCIGBACC		—	0
LCIGBINV		—	0
LCIGC		—	0
LCIGD		—	0

Table 2-115. BSIM6 Device Model Parameters

Parameter	Description	Units	Default
LCIGS		—	0
LCIT		—	0
LCKAPPAD		—	0
LCKAPPAS		—	0
LDELTA		—	0
LDLCIG		—	0
LDLCIGD		—	0
LDVTP0		—	0
LDVTP1		—	0
LDVTP2		—	0
LDVTP3		—	0
LDVTP4		—	0
LDVTP5		—	0
LEGIDL		—	0
LEGISL		—	0
LEIGBINV		—	0
LETA0		—	0
LETA0R		—	0
LETAB		—	0
LEU		—	0
LFPROUT		—	0
LIGT		—	0
LIIT		—	0
LINT	delta L for IV	—	0
LINTNOI		—	0
LK1		—	0
LK2		—	0
LK2WE		—	0
LKT1		—	0
LKT2		—	0
LKU0	Length Dependence of KU0	—	0
LKU0WE		—	0
LKVTH0	Length dependence of KVTH0	—	0
LKVTH0WE		—	0
LL		—	0
LLC		—	0

Table 2-115. BSIM6 Device Model Parameters

Parameter	Description	Units	Default
LLN		—	1
LLODKU0	Length Parameter for u0 stress effect	—	0
LLODVTH	Length Parameter for Vth stress effect	—	0
LLONG	L of extracted Long channel device	m	1e-05
LMAX	Maximum length for which this model should be used	m	100
LMIN	Minimum length for which this model should be used	m	0
LMLT	Length Shrinking Parameter	—	1
LNDEP		—	0
LNDEPCV		—	0
LNFACTOR		—	0
LNGATE		—	0
LNIGBACC		—	0
LNIGBINV		—	0
LNSD		—	0
LNTOX		—	0
LODETA0	eta0 modification foator for stress effect	—	0
LODK2	K2 shift modification factor for stress effect	—	0
LP1	Mobility channel length exponential coefficient	—	1e-08
LP2	Mobility channel length exponential coefficient	—	1e-08
LPCLM		—	0
LPCLMCV		—	0
LPCLMR		—	0
LPDIBLC		—	0
LPDIBLCB		—	0
LPDIBLCR		—	0
LPDITS		—	0
LPDITSD		—	0
LPHIN		—	0
LPOXEDGE		—	0
LPRT		—	0
LPRWB		—	0
LPRWG		—	0
LPSAT		—	0
LPSATB		—	0
LPSATR		—	0
LPSCBE1		—	0

Table 2-115. BSIM6 Device Model Parameters

Parameter	Description	Units	Default
LPSCBE2		—	0
LPTWG		—	0
LPTWGR		—	0
LPTWGT		—	0
LPVAG		—	0
LRDSW		—	0
LRDSWMIN		—	0
LRDW		—	0
LRDWMIN		—	0
LRSW		—	0
LRSWMIN		—	0
LTGIDL		—	0
LUØ		—	0
LUØR		—	0
LUA		—	0
LUA1		—	0
LUAR		—	0
LUC		—	0
LUC1		—	0
LUCR		—	0
LUCS		—	0
LUCSR		—	0
LUCSTE		—	0
LUD		—	0
LUD1		—	0
LUDR		—	0
LUTE		—	0
LVFB		—	0
LVFBCV		—	0
LVSAT		—	0
LVSATCV		—	0
LVSATR		—	0
LW		—	0
LWC		—	0
LWL		—	0
LWLC		—	0

Table 2-115. BSIM6 Device Model Parameters

Parameter	Description	Units	Default
LWN		—	1
LWR		—	0
LXJ		—	0
MJD	Drain bottom junction capacitance grading coefficient	—	0
MJS	Source bottom junction capacitance grading coefficient	—	0.5
MJSWD	Drain sidewall junction capacitance grading coefficient	—	0
MJSWGD	Drain-side gate sidewall junction capacitance grading coefficient	—	0
MJSWGS	Source-side gate sidewall junction capacitance grading coefficient	—	0
MJSWS	Source sidewall junction capacitance grading coefficient	—	0.33
MOBSCALE	Mobility scaling model, 0: Old Model, 1: New Model	—	0
MULU0		—	1
NDEP	Channel Doping Concentration for IV	m^{-3}	1e+24
NDEPCV	Channel Doping Concentration for CV	m^{-3}	0
NDEPCVL1	Length dependence coefficient of NDEPCV	—	0
NDEPCVL2	Length dependence coefficient of NDEPCV - For Short Channel Devices	—	0
NDEPCVLEXP1	Length dependence exponent coefficient of NDEPCV	—	0
NDEPCVLEXP2	Length dependence exponent coefficient of NDEPCV	—	0
NDEPCVW	Width dependence coefficient of NDEPCV	—	0
NDEPCVWEXP	Width dependence exponent coefficient of NDEPCV	—	0
NDEPCVWL	Width-Length dependence coefficient of NDEPCV	—	0
NDEPCVWLEXP	Width-Length dependence exponent coefficient of NDEPCV	—	0
NDEPL1	Length dependence coefficient of NDEP	—	0
NDEPL2	Length dependence of NDEP - For Short Channel Devices	—	0
NDEPLEXP1	Length dependence exponent coefficient of NDEP	—	1
NDEPLEXP2	Length dependence exponent coefficient of NDEP	—	2
NDEPW	Width dependence coefficient of NDEP	—	0
NDEPWEXP	Width dependence exponent coefficient of NDEP	—	1
NDEPWL	Width-Length dependence coefficient of NDEP	—	0
NDEPWLEXP	Width-Length dependence exponent coefficient of NDEP	—	1

Table 2-115. BSIM6 Device Model Parameters

Parameter	Description	Units	Default
NFACTOR	Sub-threshold slope factor	—	0
NFACTOREDGE		—	0
NFACTORL	Length dependence coefficient of NFACTOR	—	0
NFACTORLEXP	Length dependence exponent coefficient of NFACTOR	—	1
NFACTORW	Width dependence coefficient of NFACTOR	—	0
NFACTORWEXP	Width dependence exponent coefficient of NFACTOR	—	1
NFACTORWL	Width-Length dependence coefficient of NFACTOR	—	0
NFACTORWLEXP	Width-Length dependence exponent coefficient of NFACTOR	—	1
NGATE	Gate Doping Concentration	m ⁻³	5e+25
NGCON	Number of gate contacts	—	1
NI0SUB	Intrinsic carrier concentration of the substrate at 300.15K	m ⁻³	1.1e+16
NIGBACC	Parameter for Igbacc slope	—	1
NIGBINV	Parameter for Igbinv slope	—	3
NJD	Drain junction emission coefficient	—	0
NJS	Source junction emission coefficient	—	1
NJTS	Non-ideality factor for JTSS	—	20
NJTSD	Non-ideality factor for JTSD	—	0
NJTSSW	Non-ideality factor for JTSSWS	—	20
NJTSSWD	Non-ideality factor for JTSSWD	—	0
NJTSSWG	Non-ideality factor for JTSSWGS	—	20
NJTSSWGD	Non-ideality factor for JTSSWGD	—	0
NOIA		—	6.25e+40
NOIB		—	3.125e+25
NOIC		—	8.75e+08
NSD	S/D Doping Concentration	m ⁻³	1e+26
NTNOI		—	1
NTOX	Exponent for Tox ratio	—	1
PA1		—	0
PA11		—	0
PA2		—	0
PA21		—	0
PAGIDL		—	0
PAGISL		—	0
PAIGBACC		—	0

Table 2-115. BSIM6 Device Model Parameters

Parameter	Description	Units	Default
PAIGBINV		—	0
PAIGC		—	0
PAIGD		—	0
PAIGS		—	0
PALPHA0		—	0
PAT		—	0
PBD	Drain-side bulk junction built-in potential	—	0
PBETA0		—	0
PBGIDL		—	0
PBGISL		—	0
PBIGBACC		—	0
PBIGBINV		—	0
PBIGC		—	0
PBIGD		—	0
PBIGS		—	0
PBS	Source-side bulk junction built-in potential	—	1
PBSWD	Built-in potential for Drain-side sidewall junction capacitance	—	0
PBSWGD	Built-in potential for Drain-side gate sidewall junction capacitance	—	0
PBSWGS	Built-in potential for Source-side gate sidewall junction capacitance	—	0
PBSWS	Built-in potential for Source-side sidewall junction capacitance	—	1
PCDSCB		—	0
PCDSCD		—	0
PCDSCDR		—	0
PCF		F	0
PCGDL		—	0
PCGIDL		—	0
PCGISL		—	0
PCGSL		—	0
PCIGBACC		—	0
PCIGBINV		—	0
PCIGC		—	0
PCIGD		—	0
PCIGS		—	0

Table 2-115. BSIM6 Device Model Parameters

Parameter	Description	Units	Default
PCIT		—	0
PCKAPPAD		—	0
PCKAPPAS		—	0
PCLM	CLM prefactor	—	0
PCLMCV	CLM parameter for CV	—	0
PCLMCVL		—	0
PCLMCVLEXP		—	0
PCLMG	CLM prefactor gate voltage dependence	—	0
PCLML	Length dependence coefficient of PCLM	—	0
PCLMLEXP	Length dependence exponent coefficient of PCLM	—	1
PCLMR	CLM prefactor	—	0
PDELTA		—	0
PDIBLC	parameter for DIBL effect on Rout	—	0
PDIBLCB	parameter for DIBL effect on Rout	—	0
PDIBLCL	Length dependence coefficient of PDIBLC	—	0
PDIBLCLEXP	Length dependence exponent coefficient of PDIBLC	—	1
PDIBLCLEXP	Length dependence exponent coefficient of PDIBLC	—	0
PDIBLCLR	Length dependence coefficient of PDIBLC	—	0
PDIBLCR	parameter for DIBL effect on Rout	—	0
PDITS	Coefficient for drain-induced Vth shifts	—	0
PDITSD	Vds dep of drain-induced Vth shifts	—	0
PDITSL	L dep of drain-induced Vth shifts	—	0
PDLICIG		—	0
PDLICIGD		—	0
PDVTP0		—	0
PDVTP1		—	0
PDVTP2		—	0
PDVTP3		—	0
PDVTP4		—	0
PDVTP5		—	0
PEGIDL		—	0
PEGISL		—	0
PEIGBINV		—	0
PERMOD	Whether PS/PD (when given) include gate-edge perimeter	—	1
PETA0		—	0

Table 2-115. BSIM6 Device Model Parameters

Parameter	Description	Units	Default
PETA0R		—	0
PETAB		—	0
PEU		—	0
PFPROUT		—	0
PHIN	Nonuniform vertical doping effect on surface potential, V	V	0.045
PIGCD	Igc, S/D partition parameter	—	1
PIGCDL	Length dependence coefficient of PIGCD	—	0
PIGT		—	0
PIIT		—	0
PK1		—	0
PK2		—	0
PK2WE		—	0
PKT1		—	0
PKT2		—	0
PKU0	Cross Term Dependence of KU0	—	0
PKU0WE		—	0
PKVTH0	Cross-term dependence of KVTH0	—	0
PKVTH0WE		—	0
PNDEP		—	0
PNDEPCV		—	0
PNFACTOR		—	0
PNGATE		—	0
PNIGBACC		—	0
PNIGBINV		—	0
PNSD		—	0
PNTOX		—	0
POXEDGE	Factor for the gate edge Tox	—	1
PPCLM		—	0
PPCLMCV		—	0
PPCLMR		—	0
PPDIBLC		—	0
PPDIBLCB		—	0
PPDIBLCR		—	0
PPDITS		—	0
PPDITSD		—	0

Table 2-115. BSIM6 Device Model Parameters

Parameter	Description	Units	Default
PPHIN		—	0
PPOXEDGE		—	0
PPRT		—	0
PPRWB		—	0
PPRWG		—	0
PPSAT		—	0
PPSATB		—	0
PPSATR		—	0
PPSCBE1		—	0
PPSCBE2		—	0
PPTWG		—	0
PPTWGR		—	0
PPTWGT		—	0
PPVAG		—	0
PRDSW		—	0
PRDSWMIN		—	0
PRDW		—	0
PRDWMIN		—	0
PRSW		—	0
PRSWMIN		—	0
PRT	Temperature coefficient for resistance	—	0
PRWB	Body bias dependence of resistance	—	0
PRWBL	Length dependence coefficient of PPRWB	—	0
PRWBLEXP	Length dependence exponent coefficient of PPRWB	—	1
PRWG	gate bias dependence of S/D extension resistance	—	1
PSAT	Gmsat variation with gate bias	—	1
PSATB	Body bias effect on Idsat	—	0
PSATL		—	0
PSATLEXP		—	1
PSATR	Gmsat variation with gate bias	—	0
PSATX		—	1
PSCBE1	Substrate current body-effect coeff	—	4.24e+08
PSCBE2	Substrate current body-effect coeff	—	1e-08
PTGIDL		—	0
PTWG	Idsat variation with gate bias	—	0
PTWGL	Length dependence coefficient of PTWG	—	0

Table 2-115. BSIM6 Device Model Parameters

Parameter	Description	Units	Default
PTWGLEXP	Length dependence exponent coefficient of PTWG	—	1
PTWGLEXPR	Length dependence exponent coefficient of PTWG	—	0
PTWGLR	Length dependence coefficient of PTWG	—	0
PTWGR	Idsat variation with gate bias	—	0
PTWGT	Temperature coefficient for PTWG	—	0
PTWGTL	Length Scaling parameter for PTWGT	—	0
PU0		—	0
PU0R		—	0
PUA		—	0
PUA1		—	0
PUAR		—	0
PUC		—	0
PUC1		—	0
PUCR		—	0
PUCS		—	0
PUCSR		—	0
PUCSTE		—	0
PUD		—	0
PUD1		—	0
PUDR		—	0
PUTE		—	0
PVAG	Vg dependence of early voltage	—	1
PVFB		—	0
PVFCV		—	0
PVSAT		—	0
PVSATCV		—	0
PVSATR		—	0
PWR		—	0
PXJ		—	0
QM0	Charge centroid parameter - starting point for QME in inversion	—	0.001
RBDB	Resistance between bNode and dbNode	—	50
RBDBX0	Scaling prefactor for RBDBX	—	100
RBDBY0	Scaling prefactor for RBDBY	—	100
RBODYMOD	Distributed body R model	—	0
RBPB	Resistance between bNodePrime and bNode	—	50

Table 2-115. BSIM6 Device Model Parameters

Parameter	Description	Units	Default
RBPBX0		—	100
RBPBXL	Length Scaling parameter for RBPBX	—	0
RBPBXNF	Number of fingers Scaling parameter for RBPBX	—	0
RBPBXW	Width Scaling parameter for RBPBX	—	0
RBPBY0	Scaling prefactor for RBPBY	—	100
RBPBYL	Length Scaling parameter for RBPBY	—	0
RBPBYNF	Number of fingers Scaling parameter for RBPBY	—	0
RBPBYW	Width Scaling parameter for RBPBY	—	0
RBDP	Resistance between bNodePrime and bNode	—	50
RBDP0		—	50
RBDPL	Length Scaling parameter for RBDP	—	0
RBDPNF	Number of fingers Scaling parameter for RBDP	—	0
RBDPW	Width Scaling parameter for RBDP	—	0
RBPS	Resistance between bNodePrime and sbNode	—	50
RBPS0	Scaling prefactor for RBPS 50 Ohms	—	50
RBPSL		—	0
RBPSNF		—	0
RBPSW		—	0
RBSB	Resistance between bNode and sbNode	—	50
RBSBX0	Scaling prefactor for RBSBX	—	100
RBSBY0	Scaling prefactor for RBSBY	—	100
RBSDBXL	Length Scaling parameter for RBSBX and RBDBX	—	0
RBSDBXNF	Number of fingers Scaling parameter for RBSBX and RBDBX	—	0
RBSDBXW	Width Scaling parameter for RBSBX and RBDBX	—	0
RBSDBYL	Length Scaling parameter for RBSBY and RBDBY	—	0
RBSDBYNF	Number of fingers Scaling parameter for RBSBY and RBDBY	—	0
RBSDBYW	Width Scaling parameter for RBSBY and RBDBY	—	0
RDSMOD	0: Internal bias dependent and external bias independent s/d resistance model, 1: External s/d resistance model, 2: Internal s/d resistance model	—	0
RDSW	zero bias Resistance (RDSMOD=0 and RDSMOD=2)	—	20
RDSWL	Geometrical scaling of RDSW (RDSMOD=0 and RDSMOD=2)	—	0
RDSWLEXP	Geometrical scaling of RDSW (RDSMOD=0 and RDSMOD=2)	—	1

Table 2-115. BSIM6 Device Model Parameters

Parameter	Description	Units	Default
RDSWMIN	S/D Resistance per unit width at high Vgs (RDSMOD=0 and RDSMOD=2)	—	0
RDW	zero bias Drain Resistance (RDSMOD=1)	—	0
RDWL	Geometrical scaling of RDW (RDSMOD=1)	—	0
RDWLEXP	Geometrical scaling of RDW (RDSMOD=1)	—	0
RDWMIN	Drain Resistance per unit width at high Vgs (RDSMOD=1)	—	0
RGATEMOD	Gate resistance model selector	—	0
RGEOMOD	Geometry-dependent source/drain resistance, 0: RSH-based, 1: Holistic	—	0
RNOIA	TNOIMOD = 1	—	0.577
RNOIB	TNOIMOD = 1	—	0.5164
RNOIC	TNOIMOD = 1	—	0.395
RSH	Source-drain sheet resistance	—	0
RSHG	Gate sheet resistance	—	0.1
RSW	zero bias Source Resistance (RDSMOD=1)	—	10
RSWL	Geometrical scaling of RSW (RDSMOD=1)	—	0
RSWLEXP	Geometrical scaling of RSW (RDSMOD=1)	—	1
RSWMIN	Source Resistance per unit width at high Vgs (RDSMOD=1)	—	0
RTH0	Thermal resistance	—	0
SA	Distance between OD edge from Poly from one side	—	0
SAREF	Reference distance between OD edge from Poly from one side	—	1e-06
SB	Distance between OD edge from Poly from other side	—	0
SBREF	Reference distance between OD edge from Poly from other side	—	1e-06
SC	Distance to a single well edge if <=0.0, turn off WPE	—	0
SCA		—	0
SCB		—	0
SCC		—	0
SCREF		—	1e-06
SD	Distance between neighboring fingers	—	0
SHMOD	0 : Self heating model OFF, 1 : Self heating model ON	—	0
STETA0	eta0 shift related to Vth0 change	—	0
STK2	K2 shift factor related to Vth change	—	0
TBGASUB	Bandgap Temperature Coefficient	—	0.000473
TBGBSUB	Bandgap Temperature Coefficient	—	636

Table 2-115. BSIM6 Device Model Parameters

Parameter	Description	Units	Default
TCJ	Temperature coefficient for CJS/CJD	—	0
TCJSW	Temperature coefficient for CJSWS/CJSWD	—	0
TCJSWG	Temperature coefficient for CJSWGS/CJSWGD	—	0
TDELTA	Temperature coefficient for DELTA	—	0
TETA0	Temperature coefficient for ETA0	—	0
TETA0EDGE		—	0
TGIDL	Temperature coefficient for GIDL/GISL	—	0
TKU0	Temperature Coefficient for KU0	—	0
TNFACTOR	Temperature exponent for NFACTOR	—	0
TNFACTOREDGE		—	0
TNJTS	Temperature coefficient for NJTS	—	0
TNJTSD	Temperature coefficient for NJTSD	—	0
TNJTSSW	Temperature coefficient for NJTSSW	—	0
TNJTSSWD	Temperature coefficient for NJTSSWD	—	0
TNJTSSWG	Temperature coefficient for NJTSSWG	—	0
TNJTSSWGD	Temperature coefficient for NJTSSWGD	—	0
TNOIA	TNOIMOD = 1	—	0
TNOIB	TNOIMOD = 1	—	0
TNOIC	Correlation coefficient	—	0
TNOIMOD	Thermal noise model selector	—	0
TNOM	Temperature at which the model was extracted	—	27
TOXE	Effective gate dielectric thickness relative to SiO2, m	m	3e-09
TOXP	Physical gate dielectric thickness, If not given, TOXP is calculated from TOXE and DTOX	m	0
TOXREF	Target tox value	m	3e-09
TPB	Temperature coefficient for PBS/PBD	—	0
TPBSW	Temperature coefficient for PBSWS/PBSWD	—	0
TPBSWG	Temperature coefficient for PBSWGS/PBSWGD	—	0
TYPE		—	1
U0		—	0.067
U0L	Length dependence coefficient of U0L	—	0
U0LEXP	Length dependence exponent coefficient of U0L	—	1
U0R		—	0
UA	Mobility reduction coefficient	—	0.001
UA1	Temperature coefficient for UA	—	0.001
UA1L	Length Scaling parameter for UA1	—	0

Table 2-115. BSIM6 Device Model Parameters

Parameter	Description	Units	Default
UAL	Length dependence coefficient of UA	—	0
UALEXP	Length dependence exponent coefficient of UA	—	1
UAR	Mobility reduction coefficient	—	0
UAW	Width dependence coefficient of UA	—	0
UAWEXP	Width dependence exponent coefficient of UA	—	1
UAWL	Width-Length dependence coefficient of UA	—	0
UAWLEXP	Width-Length dependence coefficient of UA	—	1
UC	Mobility reduction with body bias	—	0
UC1	Temperature coefficient for UC	—	5.6e-11
UCL	Length dependence coefficient of UC	—	0
UCLEXP	Length dependence exponent coefficient of UC	—	1
UCR	Mobility reduction with body bias	—	0
UCS	Coulombic scattering parameter	—	2
UCSR	Coulombic scattering parameter	—	0
UCSTE	Temperature coefficient for UCS	—	-0.004775
UCW	Width dependence coefficient of UC	—	0
UCWEXP	Width dependence exponent coefficient of UC	—	1
UCWL	Width-Length dependence coefficient of UC	—	0
UCWLEXP	Width-Length dependence exponent coefficient of UC	—	1
UD	Coulombic scattering parameter	—	0.001
UD1	Temperature coefficient for UD	—	0
UD1L	Length Scaling parameter for UD1	—	0
UDL	Length dependence coefficient of UD	—	0
UDLEXP	Length dependence exponent coefficient of UD	—	1
UDR	Coulombic scattering parameter	—	0
UP1	Mobility channel length coefficient	—	0
UP2	Mobility channel length coefficient	—	0
UTE	Mobility temperature exponent	—	-1.5
UTEL	Length Scaling parameter for UTE	—	0
VFB	Flat band voltage	V	-0.5
VFBCV	Flat band voltage for CV	—	0
VFBCVL	Length dependence coefficient of VFBCV	—	0
VFBCVLEXP	Length dependence exponent coefficient of VFBCV	—	1
VFBCVW	Width dependence coefficient of VFBCV	—	0
VFBCVWEXP	Width dependence exponent coefficient of VFBCV	—	1
VFBCVWL	Width-Length dependence coefficient of VFBCV	—	0

Table 2-115. BSIM6 Device Model Parameters

Parameter	Description	Units	Default
VFBCVWLEXP	Width-Length dependence coefficient of VFBCV	—	1
VFBSDOFF		—	0
VSAT	Saturation Velocity	—	100000
VSATCV	VSAT parameter for CV	—	0
VSATCVL		—	0
VSATCVLEXP		—	0
VSATCVW		—	0
VSATCVWEXP		—	0
VSATCVWL		—	0
VSATCVWLEXP		—	0
VSATL	Length dependence coefficient of of VSAT	—	0
VSATLEXP	Length dependence exponent coefficient of VSAT	—	1
VSATR	Saturation Velocity	—	0
VSATW	Width dependence coefficient of of VSAT	—	0
VSATWEXP	Width dependence exponent coefficient of of VSAT	—	1
VSATWL	Width-Length dependence coefficient of of VSAT	—	0
VSATWLEXP	Width-Length dependence exponent coefficient of of VSAT	—	1
VTSD	Bottom drain junction trap-assisted current voltage dependent parameter	—	0
VTSS	Bottom source junction trap-assisted current voltage dependent parameter	—	10
VTSSWD	Unit length trap-assisted current voltage dependent parameter for sidewall drain junction	—	0
VTSSWGD	Unit length trap-assisted current voltage dependent parameter for gate-edge sidewall drain junction	—	0
VTSSWGS	Unit length trap-assisted current voltage dependent parameter for gate-edge sidewall source junction	—	10
VTSSWS	Unit length trap-assisted current voltage dependent parameter for sidewall source junction	—	10
WA1		—	0
WA11		—	0
WA2		—	0
WA21		—	0
WAGIDL		—	0
WAGISL		—	0
WAIGBACC		—	0
WAIGBINV		—	0

Table 2-115. BSIM6 Device Model Parameters

Parameter	Description	Units	Default
WAIGC		—	0
WAIGD		—	0
WAIGS		—	0
WALPHA0		—	0
WAT		—	0
WBETA0		—	0
WBGIDL		—	0
WBGISL		—	0
WBIGBACC		—	0
WBIGBINV		—	0
WBIGC		—	0
WBIGD		—	0
WBIGS		—	0
WCDSCB		—	0
WCDSCD		—	0
WCDSCDR		—	0
WCF		F	0
WCGDL		—	0
WCGIDL		—	0
WCGISL		—	0
WCGSL		—	0
WCIGBACC		—	0
WCIGBINV		—	0
WCIGC		—	0
WCIGD		—	0
WCIGS		—	0
WCIT		—	0
WCKAPPAD		—	0
WCKAPPAS		—	0
WDELTA		—	0
WDLICIG		—	0
WDLICIGD		—	0
WDVTP0		—	0
WDVTP1		—	0
WDVTP2		—	0
WDVTP3		—	0

Table 2-115. BSIM6 Device Model Parameters

Parameter	Description	Units	Default
WDVTP4		—	0
WDVTP5		—	0
WEB		—	0
WEC		—	0
WEDGE		—	1e-08
WEGIDL		—	0
WEGISL		—	0
WEIGBINV		—	0
WETA0		—	0
WETA0R		—	0
WETAB		—	0
WEU		—	0
WFPROUT		—	0
WIGT		—	0
WIIT		—	0
WINT	delta W for IV	—	0
WK1		—	0
WK2		—	0
WK2WE		—	0
WKT1		—	0
WKT2		—	0
WKU0	Width Dependence of KU0	—	0
WKU0WE		—	0
WKVTH0	Width dependence of KVTH0	—	0
WKVTH0WE		—	0
WL		—	0
WLC		—	0
WLN		—	1
WLOD	Width Parameter for Stress Effect	—	0
WLODKU0	Width Parameter for u0 stress effect	—	0
WLODVTH	Width Parameter for Vth stress effect	—	0
WMAX	Maximum width for which this model should be used	m	0
WMIN	Minimum width for which this model should be used	m	0
WMLT	Width Shrinking Parameter	—	1
WNDEP		—	0
WNDEPCV		—	0

Table 2-115. BSIM6 Device Model Parameters

Parameter	Description	Units	Default
WFACTOR		—	0
WNGATE		—	0
WNIGBACC		—	0
WNIGBINV		—	0
WNSD		—	0
WNTOX		—	0
WPCLM		—	0
WPCLMCV		—	0
WPCLMR		—	0
WDIBLC		—	0
WDIBLCB		—	0
WDIBLCR		—	0
WDITS		—	0
WDITS		—	0
WPEMOD	Model flag	—	0
WPHIN		—	0
WPOXEDGE		—	0
WPRT		—	0
WPRWB		—	0
WPRWG		—	0
WPSAT		—	0
WPSATB		—	0
WPSATR		—	0
WPSCBE1		—	0
WPSCBE2		—	0
WPTWG		—	0
WPTWGR		—	0
WPTWGT		—	0
WPVAG		—	0
WR	W dependence parameter of S/D extension resistance	—	1
WRDSW		—	0
WRDSWMIN		—	0
WRDW		—	0
WRDWMIN		—	0
WRSW		—	0
WRSWMIN		—	0

Table 2-115. BSIM6 Device Model Parameters

Parameter	Description	Units	Default
WTGIDL		—	0
WTH0	Width dependence coefficient for Rth and Cth	—	0
WU0		—	0
WU0R		—	0
WUA		—	0
WUA1		—	0
WUAR		—	0
WUC		—	0
WUC1		—	0
WUCR		—	0
WUCS		—	0
WUCSR		—	0
WUCSTE		—	0
WUD		—	0
WUD1		—	0
WUDR		—	0
WUTE		—	0
WVFB		—	0
WVFCV		—	0
WVSAT		—	0
WVSATCV		—	0
WVSATR		—	0
WW		—	0
WWC		—	0
WWIDE	W of extracted Wide channel device	m	1e-05
WWL		—	0
WWLC		—	0
WWN		—	1
WWR		—	0
WXJ		—	0
XGL	Variation in Ldrawn	m	0
XGW	Dist from gate contact center to dev edge [m]	m	0
XJ	S/D junction depth	—	1.5e-07
XJBVD	Fitting parameter for drain diode breakdown current	—	0
XJBVS	Fitting parameter for source diode breakdown current	—	1
XL	L offset for channel length due to mask/etch effect	—	0

Table 2-115. BSIM6 Device Model Parameters

Parameter	Description	Units	Default
XRCRG1	1st fitting parm the bias-dependent Rg //make it binnable	—	12
XRCRG2	2nd fitting parm the bias-dependent Rg //make it binnable	—	1
XTID	Drain junction current temperature exponent	—	0
XTIS	Source junction current temperature exponent	—	3
XTSD	Power dependence of JTSD on temperature	—	0
XTSS	Power dependence of JTSS on temperature	—	0.02
XTSSWD	Power dependence of JTSSWD on temperature	—	0
XTSSWGD	Power dependence of JTSSWGD on temperature	—	0
XTSSWGS	Power dependence of JTSSWGS on temperature	—	0.02
XTSSWS	Power dependence of JTSSWS on temperature	—	0.02
XW	W offset for channel width due to mask/etch effect	—	0

Table 2-116. MOSFET level 77 Output Variables

Parameter	Description	Units	Default
QBI	Intrinsic Body Charge	C	none
QSI	Intrinsic Source Charge	C	none
QDI	Intrinsic Drain Charge	C	none
QGI	Intrinsic Gate Charge	C	none
CGGI	Intrinsic g-g MOSFET capacitance	F	none
CGBI	Intrinsic g-b MOSFET capacitance	F	none
CGSI	Intrinsic g-s MOSFET capacitance	F	none
CGDI	Intrinsic g-d MOSFET capacitance	F	none
CSGI	Intrinsic s-g MOSFET capacitance	F	none
CSBI	Intrinsic s-b MOSFET capacitance	F	none
CSSI	Intrinsic s-s MOSFET capacitance	F	none
CSDI	Intrinsic s-d MOSFET capacitance	F	none
CDGI	Intrinsic d-g MOSFET capacitance	F	none
CDBI	Intrinsic d-b MOSFET capacitance	F	none
CDSI	Intrinsic d-s MOSFET capacitance	F	none
CDDI	Intrinsic d-d MOSFET capacitance	F	none
CBGI	Intrinsic b-g MOSFET capacitance	F	none
CBBI	Intrinsic b-b MOSFET capacitance	F	none
CBSI	Intrinsic b-s MOSFET capacitance	F	none

Table 2-116. MOSFET level 77 Output Variables

Parameter	Description	Units	Default
CBDI	Intrinsic b-d MOSFET capacitance	F	none
QB	Body Charge	C	none
QS	Source Charge	C	none
QD	Drain Charge	C	none
QG	Gate Charge	C	none
CGG	g-g MOSFET capacitance	F	none
CGB	g-b MOSFET capacitance	F	none
CGS	g-s MOSFET capacitance	F	none
CGD	g-d MOSFET capacitance	F	none
CSG	s-g MOSFET capacitance	F	none
CSB	s-b MOSFET capacitance	F	none
CSS	s-s MOSFET capacitance	F	none
CSD	s-d MOSFET capacitance	F	none
CDG	d-g MOSFET capacitance	F	none
CDB	d-b MOSFET capacitance	F	none
CDS	d-s MOSFET capacitance	F	none
CDD	d-d MOSFET capacitance	F	none
CBG	b-g MOSFET capacitance	F	none
CBB	b-b MOSFET capacitance	F	none
CBS	b-s MOSFET capacitance	F	none
CBD	b-d MOSFET capacitance	F	none
ISUB	Substrate Current	A	none
IGIDL		A	none
IGISL		A	none
IGS		A	none
IGD		A	none
IGCS		A	none
IGCD		A	none
IGB		A	none
CGSEXT		F	none
CGDEXT		F	none
CGBOV	Front Gate Charge	F	none
CAPBS		F	none
CAPBD		F	none
WEFF		m	none
LEFF		m	none

Table 2-116. MOSFET level 77 Output Variables

Parameter	Description	Units	Default
WEFFCV		m	none
LEFFCV		m	none
IDS	Drain-Source current	A	none
IDEFF	Effective drain Current	A	none
ISEFF	Effective Source Current	A	none
IGEFF	Effective Gate Current	A	none
IBS		A	none
IBD		A	none
VDS	Drain to Source Voltage	V	none
VGS	Gate to Source Voltage	V	none
VBS	Body to Source Voltage	V	none
VDSAT		V	none
GM		mho	none
GMBS		mho	none
GDS		mho	none
TK		m	none
VTH	Threshold Voltage	V	none

2.3.20.11. Level 102 MOSFET Tables (PSP version 102.5)

Xyce includes a legacy version of the PSP MOSFET model, version 102.5. This version is provided because the more recent 103 versions are not backward compatible with the older 102 versions, and some foundries provide model cards that use the version 102. Development of new model cards should be done using the more recent, supported versions of PSP.

The PSP102 device supports output of the internal variables in table 2-119 on the .PRINT line of a netlist. To access them from a print line, use the syntax N(<instance>:<variable>) where “<instance>” refers to the name of the specific PSP102 M device in your netlist.

Table 2-117. PSP102VA legacy MOSFET 102.5 Device Instance Parameters

Parameter	Description	Units	Default
ABDRAIN	Bottom area of drain junction	–	1e-12
ABSOURCE	Bottom area of source junction	–	1e-12
AD	Bottom area of drain junction	–	1e-12
AS	Bottom area of source junction	–	1e-12
DELVTO	Threshold voltage shift parameter	–	0
FACTUO	Zero-field mobility pre-factor	–	1
L	Design length	–	1e-05
LGDRAIN	Gate-edge length of drain junction	–	1e-06
LGSOURCE	Gate-edge length of source junction	–	1e-06
LSDRAIN	STI-edge length of drain junction	–	1e-06
LSSOURCE	STI-edge length of source junction	–	1e-06
M	Alias for MULT	–	1
MULT	Number of devices in parallel	–	1
NF	Number of fingers	–	1
NGCON	Number of gate contacts	–	1
PD	Perimeter of drain junction	–	1e-06
PS	Perimeter of source junction	–	1e-06
SA	Distance between OD-edge and poly from one side	–	0
SB	Distance between OD-edge and poly from other side	–	0
SC	Distance between OD-edge and nearest well edge	–	0
SCA	Integral of the first distribution function for scattered well dopants	–	0
SCB	Integral of the second distribution function for scattered well dopants	–	0
SCC	Integral of the third distribution function for scattered well dopants	–	0
SD	Distance between neighbouring fingers	–	0
W	Design width	–	1e-05

Table 2-117. PSP102VA legacy MOSFET 102.5 Device Instance Parameters

Parameter	Description	Units	Default
XGW	Distance from the gate contact to the channel edge	–	1e-07

Table 2-118. PSP102VA legacy MOSFET 102.5 Device Model Parameters

Parameter	Description	Units	Default
A1L	Length dependence of A1	–	0
A10	Geometry independent impact-ionization pre-factor	–	1
A1W	Width dependence of A1	–	0
A20	Impact-ionization exponent at TR	–	10
A3L	Length dependence of A3	–	0
A30	Geometry independent saturation-voltage dependence of II	–	1
A3W	Width dependence of A3	–	0
A4L	Length dependence of A4	–	0
A40	Geometry independent back-bias dependence of II	–	0
A4W	Width dependence of A4	–	0
AGIDLW	Width dependence of GIDL pre-factor for drain side	–	0
AGIDLW	Width dependence of GIDL pre-factor	–	0
ALP1L1	Length dependence of CLM enhancement factor above threshold	–	0
ALP1L2	Second_order length dependence of ALP1	–	0
ALP1LEXP	Exponent for length dependence of ALP1	–	0.5
ALP1W	Width dependence of ALP1	–	0
ALP2L1	Length dependence of CLM enhancement factor below threshold	–	0
ALP2L2	Second_order length dependence of ALP2	–	0
ALP2LEXP	Exponent for length dependence of ALP2	–	0.5
ALP2W	Width dependence of ALP2	–	0
ALPL	Length dependence of ALP	–	0.0005
ALPLEXP	Exponent for length dependence of ALP	–	1
ALPNOI	Exponent for length offset for flicker noise	–	2
ALPW	Width dependence of ALP	–	0
AXL	Length dependence of AX	–	0.4
AXO	Geometry independent linear/saturation transition factor	–	18
BETW1	First higher-order width scaling coefficient of BETN	–	0

Table 2-118. PSP102VA legacy MOSFET 102.5 Device Model Parameters

Parameter	Description	Units	Default
BETW2	Second higher-order width scaling coefficient of BETN	–	0
BGIDLDO	GIDL probability factor at TR for drain side	–	41
BGIDLO	GIDL probability factor at TR	–	41
CBBTBOT	Band-to-band tunneling prefactor of bottom component for source-bulk junction	–	1e-12
CBBTBOTD	Band-to-band tunneling prefactor of bottom component for drain-bulk junction	–	1e-12
CBBTGAT	Band-to-band tunneling prefactor of gate-edge component for source-bulk junction	–	1e-18
CBBTGATD	Band-to-band tunneling prefactor of gate-edge component for drain-bulk junction	–	1e-18
CBBTSTI	Band-to-band tunneling prefactor of STI-edge component for source-bulk junction	–	1e-18
CBBTSTID	Band-to-band tunneling prefactor of STI-edge component for drain-bulk junction	–	1e-18
CFBO	Back-bias dependence of CF	–	0
CFL	Length dependence of DIBL-parameter	–	0
CFLEXP	Exponent for length dependence of CF	–	2
CFRDW	Outer fringe capacitance for 1 um wide channel for drain side	–	0
CFRW	Outer fringe capacitance for 1 um wide channel	–	0
CFW	Width dependence of CF	–	0
CGBOVL	Oxide capacitance for gate-bulk overlap for 1 um long channel	–	0
CGIDLDO	Back-bias dependence of GIDL for drain side	–	0
CGIDLO	Back-bias dependence of GIDL	–	0
CHIBO	Tunnelling barrier height	–	3.1
CJORBOT	Zero-bias capacitance per unit-of-area of bottom component for source-bulk junction	–	0.001
CJORBOTD	Zero-bias capacitance per unit-of-area of bottom component for drain-bulk junction	–	0.001
CJORGAT	Zero-bias capacitance per unit-of-length of gate-edge component for source-bulk junction	–	1e-09
CJORGATD	Zero-bias capacitance per unit-of-length of gate-edge component for drain-bulk junction	–	1e-09
CJORSTI	Zero-bias capacitance per unit-of-length of STI-edge component for source-bulk junction	–	1e-09
CJORSTID	Zero-bias capacitance per unit-of-length of STI-edge component for drain-bulk junction	–	1e-09

Table 2-118. PSP102VA legacy MOSFET 102.5 Device Model Parameters

Parameter	Description	Units	Default
CSL	Length dependence of CS	–	0
CSLEXP	Exponent for length dependence of CS	–	0
CSLW	Area dependence of CS	–	0
CSO	Geometry independent coulomb scattering parameter at TR	–	0
CSRHBOT	Shockley-Read-Hall prefactor of bottom component for source-bulk junction	–	100
CSRHBOTD	Shockley-Read-Hall prefactor of bottom component for drain-bulk junction	–	100
CSRHGAT	Shockley-Read-Hall prefactor of gate-edge component for source-bulk junction	–	0.0001
CSRHGATD	Shockley-Read-Hall prefactor of gate-edge component for drain-bulk junction	–	0.0001
CSRHSTI	Shockley-Read-Hall prefactor of STI-edge component for source-bulk junction	–	0.0001
CSRHSTID	Shockley-Read-Hall prefactor of STI-edge component for drain-bulk junction	–	0.0001
CSW	Width dependence of CS	–	0
CTATBOT	Trap-assisted tunneling prefactor of bottom component for source-bulk junction	–	100
CTATBOTD	Trap-assisted tunneling prefactor of bottom component for drain-bulk junction	–	100
CTATGAT	Trap-assisted tunneling prefactor of gate-edge component for source-bulk junction	–	0.0001
CTATGATD	Trap-assisted tunneling prefactor of gate-edge component for drain-bulk junction	–	0.0001
CTATSTI	Trap-assisted tunneling prefactor of STI-edge component for source-bulk junction	–	0.0001
CTATSTID	Trap-assisted tunneling prefactor of STI-edge component for drain-bulk junction	–	0.0001
CTL	Length dependence of interface states factor	–	0
CTLEXP	Exponent for length dependence of interface states factor	–	1
CTLW	Area dependence of interface states factor	–	0
CTO	Geometry-independent interface states factor	–	0
CTW	Width dependence of interface states factor	–	0
DLQ	Effective channel length reduction for CV	–	0
DLSIL	Silicide extension over the physical gate length	–	0
DNSUBO	Effective doping bias-dependence parameter	–	0
DPHIBL	Length dependence offset of PHIB	–	0

Table 2-118. PSP102VA legacy MOSFET 102.5 Device Model Parameters

Parameter	Description	Units	Default
DPHIBLEXP	Exponent for length dependence of offset of PHIB	–	1
DPHIBLW	Area dependence of offset of PHIB	–	0
DPHIBO	Geometry independent offset of PHIB	–	0
DPHIBW	Width dependence of offset of PHIB	–	0
DTA	Temperature offset w.r.t. ambient circuit temperature	–	0
DWQ	Effective channel width reduction for CV	–	0
EFO	Flicker noise frequency exponent	–	1
EPSROXO	Relative permittivity of gate dielectric	–	3.9
FBTRBOT	Normalization field at the reference temperature for band-to-band tunneling of bottom component for source-bulk junction	–	1e+09
FBTRBOTD	Normalization field at the reference temperature for band-to-band tunneling of bottom component for drain-bulk junction	–	1e+09
FBTRGAT	Normalization field at the reference temperature for band-to-band tunneling of gate-edge component for source-bulk junction	–	1e+09
FBTRGATD	Normalization field at the reference temperature for band-to-band tunneling of gate-edge component for drain-bulk junction	–	1e+09
FBTRSTI	Normalization field at the reference temperature for band-to-band tunneling of STI-edge component for source-bulk junction	–	1e+09
FBTRSTID	Normalization field at the reference temperature for band-to-band tunneling of STI-edge component for drain-bulk junction	–	1e+09
FBET1	Relative mobility decrease due to first lateral profile	–	0
FBET1W	Width dependence of relative mobility decrease due to first lateral profile	–	0
FBET2	Relative mobility decrease due to second lateral profile	–	0
FETAO	Effective field parameter	–	1
FJUNQ	Fraction below which source-bulk junction capacitance components are considered negligible	–	0.03
FJUNQD	Fraction below which drain-bulk junction capacitance components are considered negligible	–	0.03
FNTEXCL	Length dependence coefficient of excess noise	–	0
FNTO	Thermal noise coefficient	–	1
FOL1	First length dependence coefficient for short channel body effect	–	0

Table 2-118. PSP102VA legacy MOSFET 102.5 Device Model Parameters

Parameter	Description	Units	Default
FOL2	Second length dependence coefficient for short channel body effect	–	0
GC20	Gate current slope factor	–	0.375
GC30	Gate current curvature factor	–	0.063
GCO0	Gate tunnelling energy adjustment	–	0
IDSATRBOT	Saturation current density at the reference temperature of bottom component for source-bulk junction	–	1e-12
IDSATRBOTD	Saturation current density at the reference temperature of bottom component for drain-bulk junction	–	1e-12
IDSATRGAT	Saturation current density at the reference temperature of gate-edge component for source-bulk junction	–	1e-18
IDSATRGATD	Saturation current density at the reference temperature of gate-edge component for drain-bulk junction	–	1e-18
IDSATRSTI	Saturation current density at the reference temperature of STI-edge component for source-bulk junction	–	1e-18
IDSATRSTID	Saturation current density at the reference temperature of STI-edge component for drain-bulk junction	–	1e-18
IGINVLW	Gate channel current pre-factor for 1 um**2 channel area	–	0
IGOVDW	Gate overlap current pre-factor for 1 um wide channel for drain side	–	0
IGOVW	Gate overlap current pre-factor for 1 um wide channel	–	0
IMAX	Maximum current up to which forward current behaves exponentially	–	1000
KUO	Mobility degradation/enhancement coefficient	–	0
KUOWEL	Length dependent mobility degradation factor	–	0
KUOWELW	Area dependent mobility degradation factor	–	0
KUOWEO	Geometrical independent mobility degradation factor	–	0
KUOWEW	Width dependent mobility degradation factor	–	0
KVSAT	Saturation velocity degradation/enhancement coefficient	–	0
KVTHO	Threshold shift parameter	–	0
KVTHOWEL	Length dependent threshold shift parameter	–	0
KVTHOWELW	Area dependent threshold shift parameter	–	0
KVTHOWEO	Geometrical independent threshold shift parameter	–	0
KVTHOWEW	Width dependent threshold shift parameter	–	0
LAP	Effective channel length reduction per side	–	0
LEVEL	Model level	–	1020
LINTNOI	Length offset for flicker noise	–	0

Table 2-118. PSP102VA legacy MOSFET 102.5 Device Model Parameters

Parameter	Description	Units	Default
LKUO	Length dependence of KUO	–	0
LKVTHO	Length dependence of KVTHO	–	0
LLODKUO	Length parameter for UO stress effect	–	0
LLODVTH	Length parameter for VTH-stress effect	–	0
LODETA0	eta0 shift modification factor for stress effect	–	1
LOV	Overlap length for gate/drain and gate/source overlap capacitance	–	0
LOVD	Overlap length for gate/drain overlap capacitance	–	0
LP1	Mobility-related characteristic length of first lateral profile	–	1e-08
LP1W	Width dependence of mobility-related characteristic length of first lateral profile	–	0
LP2	Mobility-related characteristic length of second lateral profile	–	1e-08
LPCK	Char. length of lateral doping profile	–	1e-08
LPCKW	Width dependence of char. length of lateral doping profile	–	0
LVARL	Length dependence of LVAR	–	0
LVARO	Geom. independent difference between actual and programmed gate length	–	0
LVARW	Width dependence of LVAR	–	0
MEFFTATBOT	Effective mass (in units of m0) for trap-assisted tunneling of bottom component for source-bulk junction	–	0.25
MEFFTATBOTD	Effective mass (in units of m0) for trap-assisted tunneling of bottom component for drain-bulk junction	–	0.25
MEFFTATGAT	Effective mass (in units of m0) for trap-assisted tunneling of gate-edge component for source-bulk junction	–	0.25
MEFFTATGATD	Effective mass (in units of m0) for trap-assisted tunneling of gate-edge component for drain-bulk junction	–	0.25
MEFFTATSTI	Effective mass (in units of m0) for trap-assisted tunneling of STI-edge component for source-bulk junction	–	0.25
MEFFTATSTID	Effective mass (in units of m0) for trap-assisted tunneling of STI-edge component for drain-bulk junction	–	0.25
MUEO	Geometry independent mobility reduction coefficient at TR	–	0.5

Table 2-118. PSP102VA legacy MOSFET 102.5 Device Model Parameters

Parameter	Description	Units	Default
MUEW	Width dependence of mobility reduction coefficient at TR	–	0
NFALW	First coefficient of flicker noise for 1 um**2 channel area	–	8e+22
NFBLW	Second coefficient of flicker noise for 1 um**2 channel area	–	3e+07
NFCLW	Third coefficient of flicker noise for 1 um**2 channel area	–	0
NOVDO	Effective doping of overlap region for drain side	–	5e+25
NOVO	Effective doping of overlap region	–	5e+25
NPCK	Pocket doping level	–	1e+24
NPCKW	Width dependence of pocket doping NPCK due to segregation	–	0
NPL	Length dependence of gate poly-silicon doping	–	0
NPO	Geometry-independent gate poly-silicon doping	–	1e+26
NSLPO	Effective doping bias-dependence parameter	–	0.05
NSUBO	Geometry independent substrate doping	–	3e+23
NSUBW	Width dependence of background doping NSUBO due to segregation	–	0
PBOT	Grading coefficient of bottom component for source-bulk junction	–	0.5
PBOTD	Grading coefficient of bottom component for drain-bulk junction	–	0.5
PBRBOT	Breakdown onset tuning parameter of bottom component for source-bulk junction	–	4
PBRBOTD	Breakdown onset tuning parameter of bottom component for drain-bulk junction	–	4
PBRGAT	Breakdown onset tuning parameter of gate-edge component for source-bulk junction	–	4
PBRGATD	Breakdown onset tuning parameter of gate-edge component for drain-bulk junction	–	4
PBRSTI	Breakdown onset tuning parameter of STI-edge component for source-bulk junction	–	4
PBRSTID	Breakdown onset tuning parameter of STI-edge component for drain-bulk junction	–	4
PGAT	Grading coefficient of gate-edge component for source-bulk junction	–	0.5
PGATD	Grading coefficient of gate-edge component for drain-bulk junction	–	0.5
PHIGBOT	Zero-temperature bandgap voltage of bottom component for source-bulk junction	–	1.16

Table 2-118. PSP102VA legacy MOSFET 102.5 Device Model Parameters

Parameter	Description	Units	Default
PHIGBOTD	Zero-temperature bandgap voltage of bottom component for drain-bulk junction	–	1.16
PHIGGAT	Zero-temperature bandgap voltage of gate-edge component for source-bulk junction	–	1.16
PHIGGATD	Zero-temperature bandgap voltage of gate-edge component for drain-bulk junction	–	1.16
PHIGSTI	Zero-temperature bandgap voltage of STI-edge component for source-bulk junction	–	1.16
PHIGSTID	Zero-temperature bandgap voltage of STI-edge component for drain-bulk junction	–	1.16
PKUO	Cross-term dependence of KUO	–	0
PKVTHO	Cross-term dependence of KVTHO	–	0
PSTI	Grading coefficient of STI-edge component for source-bulk junction	–	0.5
PSTID	Grading coefficient of STI-edge component for drain-bulk junction	–	0.5
QMC	Quantum-mechanical correction factor	–	1
RBULKO	Bulk resistance between node BP and BI	–	0
RGO	Gate resistance	–	0
RINT	Contact resistance between silicide and ploy	–	0
RJUNDO	Drain-side bulk resistance between node BI and BD	–	0
RJUNSO	Source-side bulk resistance between node BI and BS	–	0
RSBO	Back-bias dependence of series resistance	–	0
RSGO	Gate-bias dependence of series resistance	–	0
RSHG	Gate electrode diffusion sheet resistance	–	0
RSW1	Source/drain series resistance for 1 um wide channel at TR	–	2500
RSW2	Higher-order width scaling of RS	–	0
RVPOLY	Vertical poly resistance	–	0
RWELLO	Well resistance between node BI and B	–	0
SAREF	Reference distance between OD-edge and poly from one side	–	1e-06
SBREF	Reference distance between OD-edge and poly from other side	–	1e-06
SCREF	Distance between OD-edge and well edge of a reference device	–	1e-06
STA20	Temperature dependence of A2	–	0
STBETL	Length dependence of temperature dependence of BETN	–	0

Table 2-118. PSP102VA legacy MOSFET 102.5 Device Model Parameters

Parameter	Description	Units	Default
STBETLW	Area dependence of temperature dependence of BETN	–	0
STBETO	Geometry independent temperature dependence of BETN	–	1
STBETW	Width dependence of temperature dependence of BETN	–	0
STBGIDLDO	Temperature dependence of BGIDL for drain side	–	0
STBGIDL0	Temperature dependence of BGIDL	–	0
STCSO	Temperature dependence of CS	–	0
STETA0	eta0 shift factor related to VTHO change	–	0
STFBBTBOT	Temperature scaling parameter for band-to-band tunneling of bottom component for source-bulk junction	–	-0.001
STFBBTBOTD	Temperature scaling parameter for band-to-band tunneling of bottom component for drain-bulk junction	–	-0.001
STFBBTGAT	Temperature scaling parameter for band-to-band tunneling of gate-edge component for source-bulk junction	–	-0.001
STFBBTGATD	Temperature scaling parameter for band-to-band tunneling of gate-edge component for drain-bulk junction	–	-0.001
STFBBTSTI	Temperature scaling parameter for band-to-band tunneling of STI-edge component for source-bulk junction	–	-0.001
STFBBTSTID	Temperature scaling parameter for band-to-band tunneling of STI-edge component for drain-bulk junction	–	-0.001
STIGO	Temperature dependence of IGINV and IGOV	–	2
STMUE0	Temperature dependence of MUE	–	0
STRSO	Temperature dependence of RS	–	1
STTHEMU0	Temperature dependence of THEMU	–	1.5
STTHESATL	Length dependence of temperature dependence of THESAT	–	0
STTHESATLW	Area dependence of temperature dependence of THESAT	–	0
STTHESATO	Geometry independent temperature dependence of THESAT	–	1
STTHESATW	Width dependence of temperature dependence of THESAT	–	0

Table 2-118. PSP102VA legacy MOSFET 102.5 Device Model Parameters

Parameter	Description	Units	Default
STVFBL	Length dependence of temperature dependence of VFB	–	0
STVFBLW	Area dependence of temperature dependence of VFB	–	0
STVFBO	Geometry-independent temperature dependence of VFB	–	0.0005
STVFBW	Width dependence of temperature dependence of VFB	–	0
STXCORO	Temperature dependence of XCOR	–	0
SWGIDL	Flag for GIDL current, 0=turn off IGIDL	–	0
SWGATE	Flag for gate current, 0=turn off IG	–	0
SWIMPACT	Flag for impact ionization current, 0=turn off II	–	0
SWJUNASYM	Flag for asymmetric junctions; 0=symmetric, 1=asymmetric	–	0
SWJUNCAP	Flag for juncap, 0=turn off juncap	–	0
SWJUNEXP	Flag for JUNCAP-express; 0=full model, 1=express model	–	0
THEMUO	Mobility reduction exponent at TR	–	1.5
THESATBO	Back-bias dependence of velocity saturation	–	0
THESATGO	Gate-bias dependence of velocity saturation	–	0
THESATL	Length dependence of THESAT	–	0.05
THESATLEXP	Exponent for length dependence of THESAT	–	1
THESATLW	Area dependence of velocity saturation parameter	–	0
THESATO	Geometry independent velocity saturation parameter at TR	–	0
THESATW	Width dependence of velocity saturation parameter	–	0
TKUO	Temperature dependence of KUO	–	0
TOXO	Gate oxide thickness	–	2e-09
TOXOVDO	Overlap oxide thickness for drain side	–	2e-09
TOXOVO	Overlap oxide thickness	–	2e-09
TR	nominal (reference) temperature	–	21
TRJ	reference temperature	–	21
TYPE	Channel type parameter, +1=NMOS -1=PMOS	–	1
UO	Zero-field mobility at TR	–	0.05
VBIRBOT	Built-in voltage at the reference temperature of bottom component for source-bulk junction	–	1
VBIRBOTD	Built-in voltage at the reference temperature of bottom component for drain-bulk junction	–	1
VBIRGAT	Built-in voltage at the reference temperature of gate-edge component for source-bulk junction	–	1

Table 2-118. PSP102VA legacy MOSFET 102.5 Device Model Parameters

Parameter	Description	Units	Default
VBIRGATD	Built-in voltage at the reference temperature of gate-edge component for drain-bulk junction	–	1
VBIRSTI	Built-in voltage at the reference temperature of STI-edge component for source-bulk junction	–	1
VBIRSTID	Built-in voltage at the reference temperature of STI-edge component for drain-bulk junction	–	1
VBRBOT	Breakdown voltage of bottom component for source-bulk junction	–	10
VBRBOTD	Breakdown voltage of bottom component for drain-bulk junction	–	10
VBRGAT	Breakdown voltage of gate-edge component for source-bulk junction	–	10
VBRGATD	Breakdown voltage of gate-edge component for drain-bulk junction	–	10
VBRSTI	Breakdown voltage of STI-edge component for source-bulk junction	–	10
VBRSTID	Breakdown voltage of STI-edge component for drain-bulk junction	–	10
VFBL	Length dependence of flat-band voltage	–	0
VFBLW	Area dependence of flat-band voltage	–	0
VFBO	Geometry-independent flat-band voltage at TR	–	-1
VFBW	Width dependence of flat-band voltage	–	0
VJUNREF	Typical maximum source-bulk junction voltage; usually about 2*VSUP	–	2.5
VJUNREFD	Typical maximum drain-bulk junction voltage; usually about 2*VSUP	–	2.5
VNSUBO	Effective doping bias-dependence parameter	–	0
VPO	CLM logarithmic dependence parameter	–	0.05
WBET	Characteristic width for width scaling of BETN	–	1e-09
WEB	Coefficient for SCB	–	0
WEC	Coefficient for SCC	–	0
WKUO	Width dependence of KUO	–	0
WKVTHO	Width dependence of KVTHO	–	0
WLOD	Width parameter	–	0
WLODKUO	Width parameter for UO stress effect	–	0
WLODVTH	Width parameter for VTH-stress effect	–	0
WOT	Effective channel width reduction per side	–	0
WSEG	Char. length of segregation of background doping NSUBO	–	1e-08

Table 2-118. PSP102VA legacy MOSFET 102.5 Device Model Parameters

Parameter	Description	Units	Default
WSEGP	Char. length of segregation of pocket doping NPCK	–	1e-08
WVARL	Length dependence of WVAR	–	0
WVARO	Geom. independent difference between actual and programmed field-oxide opening	–	0
WVARW	Width dependence of WVAR	–	0
XCORL	Length dependence of non-universality parameter	–	0
XCORLW	Area dependence of non-universality parameter	–	0
XCORO	Geometry independent non-universality parameter	–	0
XCORW	Width dependence of non-universality parameter	–	0
XJUNGAT	Junction depth of gate-edge component for source-bulk junction	–	1e-07
XJUNGATD	Junction depth of gate-edge component for drain-bulk junction	–	1e-07
XJUNSTI	Junction depth of STI-edge component for source-bulk junction	–	1e-07
XJUNSTID	Junction depth of STI-edge component for drain-bulk junction	–	1e-07

Table 2-119. MOSFET level 102 Output Variables

Parameter	Description	Units	Default
c _{type}	Flag for channel type		none
s _{dint}	Flag for source-drain interchange		none
i _{se}	Total source current	A	none
i _{ge}	Total gate current	A	none
i _{de}	Total drain current	A	none
i _{be}	Total bulk current	A	none
i _{ds}	Drain current, excl. avalanche, tunnel, GISL, GIDL, and junction currents	A	none
i _{db}	Drain to bulk current	A	none
i _{sb}	Source to bulk current	A	none
i _{gs}	Gate-source tunneling current	A	none
i _{gd}	Gate-drain tunneling current	A	none
i _{gb}	Gate-bulk tunneling current	A	none
i _{gcs}	Gate-channel tunneling current (source component)	A	none
i _{gcd}	Gate-channel tunneling current (drain component)	A	none
i _{avl}	Substrate current due to weak avalanche	A	none
i _{gisl}	Gate-induced source leakage current	A	none

Table 2-119. MOSFET level 102 Output Variables

Parameter	Description	Units	Default
igidl	Gate-induced drain leakage current	A	none
ijs	Total source junction current	A	none
ijsbot	Source junction current (bottom component)	A	none
ijsgat	Source junction current (gate-edge component)	A	none
ijssti	Source junction current (STI-edge component)	A	none
ijd	Total drain junction current	A	none
ijdbot	Drain junction current (bottom component)	A	none
ijdgat	Drain junction current (gate-edge component)	A	none
ijdsti	Drain junction current (STI-edge component)	A	none
vds	Drain-source voltage	V	none
vgs	Gate-source voltage	V	none
vsb	Source-bulk voltage	V	none
vto	Zero-bias threshold voltage	V	none
vtb	Threshold voltage including back bias effects	V	none
vth	Threshold voltage including back bias and drain bias effects	V	none
vgt	Effective gate drive voltage including back bias and drain bias effects	V	none
vdss	Drain saturation voltage at actual bias	V	none
vsat	Saturation limit	V	none
gm	Transconductance	Ω^{-1}	none
gmb	Substrate transconductance	Ω^{-1}	none
gds	Output conductance	Ω^{-1}	none
gjs	Source junction conductance	Ω^{-1}	none
gjd	Drain junction conductance	Ω^{-1}	none
cdd	Drain capacitance	F	none
cdg	Drain-gate capacitance	F	none
cds	Drain-source capacitance	F	none
cdb	Drain-bulk capacitance	F	none
cgd	Gate-drain capacitance	F	none
cgg	Gate capacitance	F	none
cgs	Gate-source capacitance	F	none
cgb	Gate-bulk capacitance	F	none
csd	Source-drain capacitance	F	none
csg	Source-gate capacitance	F	none
css	Source capacitance	F	none

Table 2-119. MOSFET level 102 Output Variables

Parameter	Description	Units	Default
csb	Source-bulk capacitance	F	none
cbd	Bulk-drain capacitance	F	none
cbg	Bulk-gate capacitance	F	none
cbs	Bulk-source capacitance	F	none
cbb	Bulk capacitance	F	none
cgso1	Total gate-source overlap capacitance	F	none
cgdo1	Total gate-drain overlap capacitance	F	none
cjs	Total source junction capacitance	F	none
cjsbot	Source junction capacitance (bottom component)	F	none
cjsgat	Source junction capacitance (gate-edge component)	F	none
cjssti	Source junction capacitance (STI-edge component)	F	none
cjd	Total drain junction capacitance	F	none
cjdbot	Drain junction capacitance (bottom component)	F	none
cjdgat	Drain junction capacitance (gate-edge component)	F	none
cjdsti	Drain junction capacitance (STI-edge component)	F	none
weff	Effective channel width for geometrical models	m	none
leff	Effective channel length for geometrical models	m	none
u	Transistor gain		none
rout	Small-signal output resistance	Ohm	none
vearly	Equivalent Early voltage	V	none
beff	Gain factor	A/V ²	none
fug	Unity gain frequency at actual bias	Hz	none
rg	Gate resistance	Ohm	none
sfl	Flicker noise current spectral density at 1 Hz	A ² /Hz	none
sqrtsff	Input-referred RMS white noise voltage spectral density at 1 kHz	V/sqrt(Hz)	none
sqrtsfw	Input-referred RMS white noise voltage spectral density	V/sqrt(Hz)	none
sid	White noise current spectral density	A ² /Hz	none
sig	Induced gate noise current spectral density at 1 Hz	A ² /Hz	none
cigid	Imaginary part of correlation coefficient between Sig and Sid		none
fknee	Cross-over frequency above which white noise is dominant	Hz	none
sigs	Gate-source current noise spectral density	A ² /Hz	none
sigd	Gate-drain current noise spectral density	A ² /Hz	none
siavl	Impact ionization current noise spectral density	A ² /Hz	none

Table 2-119. MOSFET level 102 Output Variables

Parameter	Description	Units	Default
ssi	Total source junction current noise spectral density	A ² /Hz	none
sdi	Total drain junction current noise spectral density	A ² /Hz	none
lp_vfb	Local parameter VFB after T-scaling and clipping	V	none
lp_stvfb	Local parameter STVFB after clipping	V/K	none
lp_tox	Local parameter TOX after clipping	m	none
lp_epsrox	Local parameter EPSROX after clipping		none
lp_neff	Local parameter NEFF after clipping	m ⁻³	none
lp_vnsub	Local parameter VNSUB after clipping	V	none
lp_nslp	Local parameter NSLP after clipping	V	none
lp_dnsb	Local parameter DNSUB after clipping	V ⁻¹	none
lp_dphib	Local parameter DPHIB after clipping	V	none
lp_np	Local parameter NP after clipping	m ⁻³	none
lp_ct	Local parameter CT after clipping		none
lp_toxov	Local parameter TOXOV after clipping	m	none
lp_toxovd	Local parameter TOXOVD after clipping	m	none
lp_nov	Local parameter NOV after clipping	m ⁻³	none
lp_novd	Local parameter NOVD after clipping	m ⁻³	none
lp_cf	Local parameter CF after clipping		none
lp_cfb	Local parameter CFB after clipping	V ⁻¹	none
lp_betn	Local parameter BETN after T-scaling and clipping	m ² /(V s)	none
lp_stbet	Local parameter STBET after clipping		none
lp_mue	Local parameter MUE after T-scaling and clipping	m/V	none
lp_stmue	Local parameter STMUE after clipping		none
lp_themu	Local parameter THEMU after T-scaling and clipping		none
lp_stthemu	Local parameter STTHEMU after clipping		none
lp_cs	Local parameter CS after T-scaling and clipping		none
lp_stcs	Local parameter STCS after clipping		none
lp_xcor	Local parameter XCOR after T-scaling and clipping	V ⁻¹	none
lp_stxcor	Local parameter STXCOR after clipping		none
lp_feta	Local parameter FETA after clipping		none
lp_rs	Local parameter RS after T-scaling and clipping	Ohm	none
lp_strs	Local parameter STRS after clipping		none
lp_rsb	Local parameter RSB after clipping	V ⁻¹	none
lp_rsg	Local parameter RSG after clipping	V ⁻¹	none
lp_thesat	Local parameter THESAT after T-scaling and clipping	V ⁻¹	none
lp_stthesat	Local parameter STTHESAT after clipping		none

Table 2-119. MOSFET level 102 Output Variables

Parameter	Description	Units	Default
lp_thesatb	Local parameter THESATB after clipping	V ⁻¹	none
lp_thesatg	Local parameter THESATG after clipping	V ⁻¹	none
lp_ax	Local parameter AX after clipping		none
lp_alp	Local parameter ALP after clipping		none
lp_alp1	Local parameter ALP1 after clipping	V	none
lp_alp2	Local parameter ALP2 after clipping	V ⁻¹	none
lp_vp	Local parameter VP after clipping	V	none
lp_a1	Local parameter A1 after clipping		none
lp_a2	Local parameter A2 after T-scaling and clipping	V	none
lp_sta2	Local parameter STA2 after clipping		none
lp_a3	Local parameter A3 after clipping		none
lp_a4	Local parameter A4 after clipping	1/sqrt(V)	none
lp_gco	Local parameter GCO after clipping		none
lp_iginv	Local parameter IGINV after T-scaling and clipping	A	none
lp_igov	Local parameter IGOV after T-scaling and clipping	A	none
lp_igovd	Local parameter IGOVD after T-scaling and clipping	A	none
lp_stig	Local parameter STIG after clipping		none
lp_gc2	Local parameter GC2 after clipping		none
lp_gc3	Local parameter GC3 after clipping		none
lp_chib	Local parameter CHIB after clipping	V	none
lp_agidl	Local parameter AGIDL after clipping	A/V ³	none
lp_agidld	Local parameter AGIDLD after clipping	A/V ³	none
lp_bgidl	Local parameter BGIDL after T-scaling and clipping	V	none
lp_bgidld	Local parameter BGIDLD after T-scaling and clipping	V	none
lp_stbgidl	Local parameter STBGIDL after clipping	V/K	none
lp_stbgidld	Local parameter STBGIDLD after clipping	V/K	none
lp_cgidl	Local parameter CGIDL after clipping		none
lp_cgidld	Local parameter CGIDLD after clipping		none
lp_cox	Local parameter COX after clipping	F	none
lp_cgov	Local parameter CGOV after clipping	F	none
lp_cgovd	Local parameter CGOVD after clipping	F	none
lp_cgbov	Local parameter CGBOV after clipping	F	none
lp_cfr	Local parameter CFR after clipping	F	none
lp_cfrd	Local parameter CFRD after clipping	F	none
lp_fnt	Local parameter FNT after clipping		none
lp_fntexc	Local parameter FNTEXC after clipping		none

Table 2-119. MOSFET level 102 Output Variables

Parameter	Description	Units	Default
lp_nfa	Local parameter NFA after clipping	1/(V m ⁴)	none
lp_nfb	Local parameter NFB after clipping	1/(V m ²)	none
lp_nfc	Local parameter NFC after clipping	V ⁻¹	none
lp_ef	Local parameter EF after clipping		none
lp_rg	Local parameter RG after clipping	Ohm	none
lp_rbulk	Local parameter RBULK after clipping	Ohm	none
lp_rwell	Local parameter RWELL after clipping	Ohm	none
lp_rjuns	Local parameter RJUNS after clipping	Ohm	none
lp_rjund	Local parameter RJUND after clipping	Ohm	none
tk	Device Temperature	K	none
cjosbot	Bottom component of total zero-bias source junction capacitance at device temperature	F	none
cjossti	STI-edge component of total zero-bias source junction capacitance at device temperature	F	none
cjosgat	Gate-edge component of total zero-bias source junction capacitance at device temperature	F	none
vbisbot	Built-in voltage of source-side bottom junction at device temperature	V	none
vbissti	Built-in voltage of source-side STI-edge junction at device temperature	V	none
vbisgat	Built-in voltage of source-side gate-edge junction at device temperature	V	none
idsatsbot	Total source-side bottom junction saturation current	A	none
idsatssti	Total source-side STI-edge junction saturation current	A	none
idsatsgat	Total source-side gate-edge junction saturation current	A	none
cjosbotd	Bottom component of total zero-bias drain junction capacitance at device temperature	F	none
cjosstid	STI-edge component of total zero-bias drain junction capacitance at device temperature	F	none
cjosgatd	Gate-edge component of total zero-bias drain junction capacitance at device temperature	F	none
vbisbotd	Built-in voltage of drain-side bottom junction at device temperature	V	none
vbisstid	Built-in voltage of drain-side STI-edge junction at device temperature	V	none
vbisgatd	Built-in voltage of drain-side gate-edge junction at device temperature	V	none
idsatsbotd	Total drain-side bottom junction saturation current	A	none
idsatsstid	Total drain-side STI-edge junction saturation current	A	none

Table 2-119. MOSFET level 102 Output Variables

Parameter	Description	Units	Default
idsatsgatd	Total drain-side gate-edge junction saturation current	A	none

2.3.20.12. Level 103 and 1031 MOSFET Tables (PSP version 103.4)

Xyce includes the PSP MOSFET model, version 103.4 [29]. The version without self-heating is the level 103 MOSFET, and the version with self-heating is the level 1031. Note that the level 1031 MOSFET requires five nodes on its instance line: drain, gate, source, bulk, and dt. The fifth node will be the temperature rise of the device due to self-heating.

Full documentation for the PSP model is available on its web site, <http://www.cea.fr/cea-tech/leti/pspsupport>. Instance and model parameters for the PSP model are given in tables 2-120, 2-121, 2-123, and 2-124.

The PSP103 devices support output of the internal variables in table 2-122 and table 2-125 on the .PRINT line of a netlist. To access them from a print line, use the syntax N(<instance>:<variable>) where “<instance>” refers to the name of the specific PSP103 M device in your netlist.

Table 2-120. PSP103VA MOSFET Device Instance Parameters

Parameter	Description	Units	Default
ABDRAIN	Bottom area of drain junction	m ²	1e-12
ABSOURCE	Bottom area of source junction	m ²	1e-12
AD	Bottom area of drain junction	m ²	1e-12
AS	Bottom area of source junction	m ²	1e-12
DELVTO	Threshold voltage shift parameter	V	0
DELVTOEDGE	Threshold voltage shift parameter of edge transistor	V	0
DTA	Temperature offset w.r.t. ambient temperature	K	0
FACTUO	Zero-field mobility pre-factor	—	1
FACTUOEDGE	Zero-field mobility pre-factor of edge transistor	—	1
JW	Gate-edge length of source/drain junction	m	1e-06
L	Design length	m	1e-05
LGDRAIN	Gate-edge length of drain junction	m	1e-06
LGSOURCE	Gate-edge length of source junction	m	1e-06
LSDRAIN	STI-edge length of drain junction	m	1e-06
LSSOURCE	STI-edge length of source junction	m	1e-06
M	Alias for MULT	—	1
MULT	Number of devices in parallel	—	1
NF	Number of fingers	—	1
NGCON	Number of gate contacts	—	1
NRD	Number of squares of drain diffusion	—	0

Table 2-120. PSP103VA MOSFET Device Instance Parameters

Parameter	Description	Units	Default
NRS	Number of squares of source diffusion	—	0
PD	Perimeter of drain junction	m	1e-06
PS	Perimeter of source junction	m	1e-06
SA	Distance between OD-edge and poly from one side	m	0
SB	Distance between OD-edge and poly from other side	m	0
SC	Distance between OD-edge and nearest well edge	m	0
SCA	Integral of the first distribution function for scattered well dopants	—	0
SCB	Integral of the second distribution function for scattered well dopants	—	0
SCC	Integral of the third distribution function for scattered well dopants	—	0
SD	Distance between neighbouring fingers	m	0
W	Design width	m	1e-05
XGW	Distance from the gate contact to the channel edge	m	1e-07

Table 2-121. PSP103VA MOSFET Device Model Parameters

Parameter	Description	Units	Default
A1	Impact-ionization pre-factor	—	1
A1L	Length dependence of A1	—	0
A10	Geometry independent impact-ionization pre-factor	—	1
A1W	Width dependence of A1	—	0
A2	Impact-ionization exponent at TR	V	10
A20	Impact-ionization exponent at TR	V	10
A3	Saturation-voltage dependence of impact-ionization	—	1
A3L	Length dependence of A3	—	0
A30	Geometry independent saturation-voltage dependence of II	—	1
A3W	Width dependence of A3	—	0
A4	Back-bias dependence of impact-ionization	$V^{-1/2}$	0
A4L	Length dependence of A4	—	0
A40	Geometry independent back-bias dependence of II	$V^{-1/2}$	0
A4W	Width dependence of A4	—	0
AGIDL	GIDL pre-factor	A/V^3	0
AGIDLD	GIDL pre-factor for drain side	A/V^3	0
AGIDLDW	Width dependence of GIDL pre-factor for drain side	A/V^3	0

Table 2-121. PSP103VA MOSFET Device Model Parameters

Parameter	Description	Units	Default
AGIDLW	Width dependence of GIDL pre-factor	A/V^3	0
ALP	CLM pre-factor	—	0.01
ALP1	CLM enhancement factor above threshold	V	0
ALP1L1	Length dependence of CLM enhancement factor above threshold	V	0
ALP1L2	Second_order length dependence of ALP1	—	0
ALP1LEXP	Exponent for length dependence of ALP1	—	0.5
ALP1W	Width dependence of ALP1	—	0
ALP2	CLM enhancement factor below threshold	V^{-1}	0
ALP2L1	Length dependence of CLM enhancement factor below threshold	V^{-1}	0
ALP2L2	Second_order length dependence of ALP2	—	0
ALP2LEXP	Exponent for length dependence of ALP2	—	0.5
ALP2W	Width dependence of ALP2	—	0
ALPL	Length dependence of ALP	—	0.0005
ALPLEXP	Exponent for length dependence of ALP	—	1
ALPNOI	Exponent for length offset for flicker noise	—	2
ALPW	Width dependence of ALP	—	0
AX	Linear/saturation transition factor	—	3
AXL	Length dependence of AX	—	0.4
AXO	Geometry independent linear/saturation transition factor	—	18
BETEDGEW	Width scaling coefficient of edge transistor mobility	—	0
BETN	Channel aspect ratio times zero-field mobility	$m^2/(Vs)$	0.07
BETNEDGE	Channel aspect ratio times zero-field mobility of edge transistor	$m^2/(Vs)$	0.0005
BETW1	First higher-order width scaling coefficient of BETN	—	0
BETW2	Second higher-order width scaling coefficient of BETN	—	0
BGIDL	GIDL probability factor at TR	V	41
BGIDL D	GIDL probability factor at TR for drain side	V	41
BGIDLDO	GIDL probability factor at TR for drain side	V	41
BGIDL O	GIDL probability factor at TR	V	41
CBBTBOT	Band-to-band tunneling prefactor of bottom component for source-bulk junction	A/V^3	1e-12
CBBTBOTD	Band-to-band tunneling prefactor of bottom component for drain-bulk junction	A/V^3	1e-12

Table 2-121. PSP103VA MOSFET Device Model Parameters

Parameter	Description	Units	Default
CBBTGAT	Band-to-band tunneling prefactor of gate-edge component for source-bulk junction	Am/V ³	1e-18
CBBTGATD	Band-to-band tunneling prefactor of gate-edge component for drain-bulk junction	Am/V ³	1e-18
CBBTSTI	Band-to-band tunneling prefactor of STI-edge component for source-bulk junction	Am/V ³	1e-18
CBBTSTID	Band-to-band tunneling prefactor of STI-edge component for drain-bulk junction	Am/V ³	1e-18
CF	DIBL-parameter	—	0
CFB	Back bias dependence of CF	V ⁻¹	0
CFBEDGE	Bulk voltage dependence parameter of DIBL-parameter of edge transistors	V ⁻¹	0
CFBEDGEO	Bulk voltage dependence parameter of DIBL-parameter of edge transistors	V ⁻¹	0
CFBO	Back-bias dependence of CF	V ⁻¹	0
CFD	Drain voltage dependence of CF	V ⁻¹	0
CFDEEDGE	Drain voltage dependence parameter of DIBL-parameter of edge transistors	V ⁻¹	0
CFDEEDGE0	Drain voltage dependence parameter of DIBL-parameter of edge transistors	V ⁻¹	0
CFDO	Drain voltage dependence of CF	V ⁻¹	0
CFEDGE	DIBL parameter of edge transistors	—	0
CFEDGEL	Length dependence of DIBL-parameter of edge transistors	—	0
CFEDGELEXP	Exponent for length dependence of DIBL-parameter of edge transistors	—	2
CFEDGEW	Width dependence of DIBL-parameter of edge transistors	—	0
CFL	Length dependence of DIBL-parameter	—	0
CFLEXP	Exponent for length dependence of CF	—	2
CFR	Outer fringe capacitance	F	0
CFRD	Outer fringe capacitance for drain side	F	0
CFRDW	Outer fringe capacitance for 1 um wide channel for drain side	F	0
CFRW	Outer fringe capacitance for 1 um wide channel	F	0
CFW	Width dependence of CF	—	0
CGBOV	Oxide capacitance for gate-bulk overlap	F	0
CGBOVL	Oxide capacitance for gate-bulk overlap for 1 um long channel	F	0

Table 2-121. PSP103VA MOSFET Device Model Parameters

Parameter	Description	Units	Default
CGIDL	Back-bias dependence of GIDL	—	0
CGIDLD	Back-bias dependence of GIDL for drain side	—	0
CGIDLDO	Back-bias dependence of GIDL for drain side	—	0
CGIDLO	Back-bias dependence of GIDL	—	0
CGOV	Oxide capacitance for gate-drain/source overlap	F	1e-15
CGOVD	Oxide capacitance for gate-drain overlap	F	1e-15
CHIB	Tunnelling barrier height	V	3.1
CHIBO	Tunnelling barrier height	V	3.1
CJORBOT	Zero-bias capacitance per unit-of-area of bottom component for source-bulk junction	F/m ²	0.001
CJORBOTD	Zero-bias capacitance per unit-of-area of bottom component for drain-bulk junction	F/m ²	0.001
CJORGAT	Zero-bias capacitance per unit-of-length of gate-edge component for source-bulk junction	F/m	1e-09
CJORGATD	Zero-bias capacitance per unit-of-length of gate-edge component for drain-bulk junction	F/m	1e-09
CJORSTI	Zero-bias capacitance per unit-of-length of STI-edge component for source-bulk junction	F/m	1e-09
CJORSTID	Zero-bias capacitance per unit-of-length of STI-edge component for drain-bulk junction	F/m	1e-09
COX	Oxide capacitance for intrinsic channel	F	1e-14
CS	Coulomb scattering parameter at TR	—	0
CSL	Length dependence of CS	—	0
CSLEXP	Exponent for length dependence of CS	—	1
CSLW	Area dependence of CS	—	0
CSO	Geometry independent coulomb scattering parameter at TR	—	0
CSRHBOT	Shockley-Read-Hall prefactor of bottom component for source-bulk junction	A/m ³	100
CSRHBOTD	Shockley-Read-Hall prefactor of bottom component for drain-bulk junction	A/m ³	100
CSRHGAT	Shockley-Read-Hall prefactor of gate-edge component for source-bulk junction	A/m ²	0.0001
CSRHGATD	Shockley-Read-Hall prefactor of gate-edge component for drain-bulk junction	A/m ²	0.0001
CSRHSTI	Shockley-Read-Hall prefactor of STI-edge component for source-bulk junction	A/m ²	0.0001
CSRHSTID	Shockley-Read-Hall prefactor of STI-edge component for drain-bulk junction	A/m ²	0.0001

Table 2-121. PSP103VA MOSFET Device Model Parameters

Parameter	Description	Units	Default
CSW	Width dependence of CS	—	0
CT	Interface states factor	—	0
CTATBOT	Trap-assisted tunneling prefactor of bottom component for source-bulk junction	A/m ³	100
CTATBOTD	Trap-assisted tunneling prefactor of bottom component for drain-bulk junction	A/m ³	100
CTATGAT	Trap-assisted tunneling prefactor of gate-edge component for source-bulk junction	A/m ²	0.0001
CTATGATD	Trap-assisted tunneling prefactor of gate-edge component for drain-bulk junction	A/m ²	0.0001
CTATSTI	Trap-assisted tunneling prefactor of STI-edge component for source-bulk junction	A/m ²	0.0001
CTATSTID	Trap-assisted tunneling prefactor of STI-edge component for drain-bulk junction	A/m ²	0.0001
CTEDGE	Interface states factor of edge transistors	—	0
CTEDGEL	Length dependence of interface states factor of edge transistors	—	0
CTEDGELEXP	Exponent for length dependence of interface states factor of edge transistors	—	1
CTEDGE0	Geometry-independent interface states factor of edge transistors	—	0
CTL	Length dependence of interface states factor	—	0
CTLEXP	Exponent for length dependence of interface states factor	—	1
CTLW	Area dependence of interface states factor	—	0
CTO	Geometry-independent interface states factor	—	0
CTW	Width dependence of interface states factor	—	0
DELVTAC	Offset parameter for PHIB in separate charge calculation	V	0
DELVTACL	Length dependence of DELVTAC	V	0
DELVTACLEXP	Exponent for length dependence of offset of DELVTAC	—	1
DELVTACLW	Area dependence of DELVTAC	V	0
DELVTACO	Geom. independent offset parameter for PHIB in separate charge calculation	V	0
DELVTACW	Width dependence of DELVTAC	V	0
DLQ	Effective channel length reduction for CV	m	0
DLSIL	Silicide extension over the physical gate length	m	0
DNSUB	Effective doping bias-dependence parameter	V ⁻¹	0

Table 2-121. PSP103VA MOSFET Device Model Parameters

Parameter	Description	Units	Default
DNSUBO	Effective doping bias-dependence parameter	V ⁻¹	0
DPHIB	Offset parameter for PHIB	V	0
DPHIBEDGE	Offset parameter for PHIB of edge transistors	V	0
DPHIBEDGEL	Length dependence of edge transistor PHIB offset	V	0
DPHIBEDGELEXP	Exponent for length dependence of edge transistor PHIB offset	—	1
DPHIBEDGELW	Area dependence of edge transistor PHIB offset	V	0
DPHIBEDGE0	Geometry independent of edge transistor PHIB offset	V	0
DPHIBEDGEW	Width dependence of edge transistor PHIB offset	V	0
DPHIBL	Length dependence offset of PHIB	V	0
DPHIBLEXP	Exponent for length dependence of offset of PHIB	—	1
DPHIBLW	Area dependence of offset of PHIB	V	0
DPHIB0	Geometry independent offset of PHIB	V	0
DPHIBW	Width dependence of offset of PHIB	V	0
DTA	Temperature offset w.r.t. ambient temperature	K	0
DVSBNUD	Vsb-range for NUD-effect	V	1
DVSBNUD0	Vsb range for NUD-effect	V	1
DWQ	Effective channel width reduction for CV	m	0
EF	Flicker noise frequency exponent	—	1
EFEDGE	Flicker noise frequency exponent of edge transistors	—	1
EFEDGE0	Flicker noise frequency exponent	—	1
EFO	Flicker noise frequency exponent	—	1
EPSROX	Relative permittivity of gate dielectric	—	3.9
EPSROX0	Relative permittivity of gate dielectric	—	3.9
FACNEFFAC	Pre-factor for effective substrate doping in separate charge calculation	—	1
FACNEFFACL	Length dependence of FACNEFFAC	—	0
FACNEFFACLW	Area dependence of FACNEFFAC	—	0
FACNEFFACO	Geom. independent pre-factor for effective substrate doping in separate charge calculation	—	1
FACNEFFACW	Width dependence of FACNEFFAC	—	0
FBTRBOT	Normalization field at the reference temperature for band-to-band tunneling of bottom component for source-bulk junction	Vm ⁻¹	1e+09
FBTRBOTD	Normalization field at the reference temperature for band-to-band tunneling of bottom component for drain-bulk junction	Vm ⁻¹	1e+09

Table 2-121. PSP103VA MOSFET Device Model Parameters

Parameter	Description	Units	Default
FBBTRGAT	Normalization field at the reference temperature for band-to-band tunneling of gate-edge component for source-bulk junction	Vm^{-1}	1e+09
FBBTRGATD	Normalization field at the reference temperature for band-to-band tunneling of gate-edge component for drain-bulk junction	Vm^{-1}	1e+09
FBBTRSTI	Normalization field at the reference temperature for band-to-band tunneling of STI-edge component for source-bulk junction	Vm^{-1}	1e+09
FBBTRSTID	Normalization field at the reference temperature for band-to-band tunneling of STI-edge component for drain-bulk junction	Vm^{-1}	1e+09
FBET1	Relative mobility decrease due to first lateral profile	—	0
FBET1W	Width dependence of relative mobility decrease due to first lateral profile	—	0
FBET2	Relative mobility decrease due to second lateral profile	—	0
FBETEDGE	Length dependence of edge transistor mobility	—	0
FETA	Effective field parameter	—	1
FETAO	Effective field parameter	—	1
FJUNQ	Fraction below which source-bulk junction capacitance components are considered negligible	—	0.03
FJUNQD	Fraction below which drain-bulk junction capacitance components are considered negligible	—	0.03
FNT	Thermal noise coefficient	—	1
FNTEDGE	Thermal noise coefficient of edge transistors	—	1
FNTEDGE0	Thermal noise coefficient	—	1
FNTEXC	Excess noise coefficient	—	0
FNTEXCL	Length dependence coefficient of excess noise	—	0
FNTO	Thermal noise coefficient	—	1
FOL1	First length dependence coefficient for short channel body effect	—	0
FOL2	Second length dependence coefficient for short channel body effect	—	0
FREV	Coefficient for reverse breakdown current limitation	—	1000
GC2	Gate current slope factor	—	0.375
GC20	Gate current slope factor	—	0.375
GC3	Gate current curvature factor	—	0.063
GC30	Gate current curvature factor	—	0.063
GCO	Gate tunnelling energy adjustment	—	0

Table 2-121. PSP103VA MOSFET Device Model Parameters

Parameter	Description	Units	Default
GCOO	Gate tunnelling energy adjustment	—	0
GFACNUD	Body-factor change due to NUD-effect	—	1
GFACNUDL	Length dependence of GFACNUD	—	0
GFACNUDLEXP	Exponent for length dependence of GFACNUD	—	1
GFACNUDLW	Area dependence of GFACNUD	—	0
GFACNUDO	Geom. independent body-factor change due to NUD-effect	—	1
GFACNUDW	Width dependence of GFACNUD	—	0
IDSATRBOT	Saturation current density at the reference temperature of bottom component for source-bulk junction	A/m ²	1e-12
IDSATRBOTD	Saturation current density at the reference temperature of bottom component for drain-bulk junction	A/m ²	1e-12
IDSATRGAT	Saturation current density at the reference temperature of gate-edge component for source-bulk junction	A/m	1e-18
IDSATRGATD	Saturation current density at the reference temperature of gate-edge component for drain-bulk junction	A/m	1e-18
IDSATRSTI	Saturation current density at the reference temperature of STI-edge component for source-bulk junction	A/m	1e-18
IDSATRSTID	Saturation current density at the reference temperature of STI-edge component for drain-bulk junction	A/m	1e-18
IGINV	Gate channel current pre-factor	A	0
IGINVLW	Gate channel current pre-factor for 1 um**2 channel area	A	0
IGOV	Gate overlap current pre-factor	A	0
IGOVD	Gate overlap current pre-factor for drain side	A	0
IGOVDW	Gate overlap current pre-factor for 1 um wide channel for drain side	A	0
IGOVW	Gate overlap current pre-factor for 1 um wide channel	A	0
IMAX	Maximum current up to which forward current behaves exponentially	A	1000
KUO	Mobility degradation/enhancement coefficient	m	0
KUOWEL	Length dependent mobility degradation factor	—	0
KUOWELW	Area dependent mobility degradation factor	—	0
KUOWEO	Geometrical independent mobility degradation factor	—	0
KUOWEW	Width dependent mobility degradation factor	—	0
KVSAT	Saturation velocity degradation/enhancement coefficient	m	0
KVTHO	Threshold shift parameter	Vm	0
KVTHOWEL	Length dependent threshold shift parameter	—	0

Table 2-121. PSP103VA MOSFET Device Model Parameters

Parameter	Description	Units	Default
KVTHOWELW	Area dependent threshold shift parameter	—	0
KVTHOWEO	Geometrical independent threshold shift parameter	—	0
KVTHOWEW	Width dependent threshold shift parameter	—	0
LAP	Effective channel length reduction per side	m	0
LEVEL	Model level	—	103
LINTNOI	Length offset for flicker noise	m	0
LKUO	Length dependence of KUO	—	0
LKVTHO	Length dependence of KVTHO	—	0
LLODKUO	Length parameter for UO stress effect	—	0
LLODVTH	Length parameter for VTH-stress effect	—	0
LMAX	Dummy parameter to label binning set	m	1
LMIN	Dummy parameter to label binning set	m	0
LODETAO	Eta0 shift modification factor for stress effect	—	1
LOV	Overlap length for gate/drain and gate/source overlap capacitance	m	0
LOVD	Overlap length for gate/drain overlap capacitance	m	0
LP1	Mobility-related characteristic length of first lateral profile	m	1e-08
LP1W	Width dependence of mobility-related characteristic length of first lateral profile	—	0
LP2	Mobility-related characteristic length of second lateral profile	m	1e-08
LPCK	Char. length of lateral doping profile	m	1e-08
LPCKW	Width dependence of char. length of lateral doping profile	—	0
LPEDGE	Exponent for length dependence of edge transistor mobility	m	1e-08
LVARL	Length dependence of LVAR	—	0
LVARO	Geom. independent difference between actual and programmed gate length	m	0
LVARW	Width dependence of LVAR	—	0
MEFFTATBOT	Effective mass (in units of m0) for trap-assisted tunneling of bottom component for source-bulk junction	—	0.25
MEFFTATBOTD	Effective mass (in units of m0) for trap-assisted tunneling of bottom component for drain-bulk junction	—	0.25

Table 2-121. PSP103VA MOSFET Device Model Parameters

Parameter	Description	Units	Default
MEFFTATGAT	Effective mass (in units of m0) for trap-assisted tunneling of gate-edge component for source-bulk junction	—	0.25
MEFFTATGATD	Effective mass (in units of m0) for trap-assisted tunneling of gate-edge component for drain-bulk junction	—	0.25
MEFFTATSTI	Effective mass (in units of m0) for trap-assisted tunneling of STI-edge component for source-bulk junction	—	0.25
MEFFTATSTID	Effective mass (in units of m0) for trap-assisted tunneling of STI-edge component for drain-bulk junction	—	0.25
MUE	Mobility reduction coefficient at TR	m/V	0.5
MUEO	Geometry independent mobility reduction coefficient at TR	m/V	0.5
MUEW	Width dependence of mobility reduction coefficient at TR	—	0
NEFF	Effective substrate doping	m ⁻³	5e+23
NEFFEDGE	Effective substrate doping of edge transistors	m ⁻³	5e+23
NFA	First coefficient of flicker noise	—	8e+22
NFAEDGE	First coefficient of flicker noise of edge transistors	—	8e+22
NFAEDGELW	First coefficient of flicker noise for 1 um**2 channel area	—	8e+22
NFALW	First coefficient of flicker noise for 1 um**2 channel area	—	8e+22
NFB	Second coefficient of flicker noise	—	3e+07
NFBEDGE	Second coefficient of flicker noise of edge transistors	—	3e+07
NFBEDGELW	Second coefficient of flicker noise for 1 um**2 channel area	—	3e+07
NFBLW	Second coefficient of flicker noise for 1 um**2 channel area	—	3e+07
NFC	Third coefficient of flicker noise	V ⁻¹	0
NFCEDGE	Third coefficient of flicker noise of edge transistors	V ⁻¹	0
NFCEDGELW	Third coefficient of flicker noise for 1 um**2 channel area	V ⁻¹	0
NFCLW	Third coefficient of flicker noise for 1 um**2 channel area	V ⁻¹	0
NOV	Effective doping of overlap region	m ⁻³	5e+25
NOVD	Effective doping of overlap region for drain side	m ⁻³	5e+25
NOVDO	Effective doping of overlap region for drain side	m ⁻³	5e+25

Table 2-121. PSP103VA MOSFET Device Model Parameters

Parameter	Description	Units	Default
NOVO	Effective doping of overlap region	m ⁻³	5e+25
NP	Gate poly-silicon doping	m ⁻³	1e+26
NPCK	Pocket doping level	m ⁻³	1e+24
NPCKW	Width dependence of pocket doping NPCK due to segregation	—	0
NPL	Length dependence of gate poly-silicon doping	—	0
NPO	Geometry-independent gate poly-silicon doping	m ⁻³	1e+26
NSLP	Effective doping bias-dependence parameter	V	0.05
NSLPO	Effective doping bias-dependence parameter	V	0.05
NSUBEDGEL	Length dependence of edge transistor substrate doping	—	0
NSUBEDGELW	Area dependence of edge transistor substrate doping	—	0
NSUBEDGE0	Geometry independent substrate doping of edge transistors	m ⁻³	5e+23
NSUBEDGEW	Width dependence of edge transistor substrate doping	—	0
NSUBO	Geometry independent substrate doping	m ⁻³	3e+23
NSUBW	Width dependence of background doping NSUBO due to segregation	—	0
PBOT	Grading coefficient of bottom component for source-bulk junction	—	0.5
PBOTD	Grading coefficient of bottom component for drain-bulk junction	—	0.5
PBRBOT	Breakdown onset tuning parameter of bottom component for source-bulk junction	V	4
PBRBOTD	Breakdown onset tuning parameter of bottom component for drain-bulk junction	V	4
PBRGAT	Breakdown onset tuning parameter of gate-edge component for source-bulk junction	V	4
PBRGATD	Breakdown onset tuning parameter of gate-edge component for drain-bulk junction	V	4
PBRSTI	Breakdown onset tuning parameter of STI-edge component for source-bulk junction	V	4
PBRSTID	Breakdown onset tuning parameter of STI-edge component for drain-bulk junction	V	4
PGAT	Grading coefficient of gate-edge component for source-bulk junction	—	0.5
PGATD	Grading coefficient of gate-edge component for drain-bulk junction	—	0.5
PHIGBOT	Zero-temperature bandgap voltage of bottom component for source-bulk junction	V	1.16

Table 2-121. PSP103VA MOSFET Device Model Parameters

Parameter	Description	Units	Default
PHIGBOTD	Zero-temperature bandgap voltage of bottom component for drain-bulk junction	V	1.16
PHIGGAT	Zero-temperature bandgap voltage of gate-edge component for source-bulk junction	V	1.16
PHIGGATD	Zero-temperature bandgap voltage of gate-edge component for drain-bulk junction	V	1.16
PHIGSTI	Zero-temperature bandgap voltage of STI-edge component for source-bulk junction	V	1.16
PHIGSTID	Zero-temperature bandgap voltage of STI-edge component for drain-bulk junction	V	1.16
PKUO	Cross-term dependence of KUO	—	0
PKVTHO	Cross-term dependence of KVTHO	—	0
PLA1	Coefficient for the length dependence of A1	—	0
PLA3	Coefficient for the length dependence of A3	—	0
PLA4	Coefficient for the length dependence of A4	$V^{-1/2}$	0
PLAGIDL	Coefficient for the length dependence of AGIDL	A/V^3	0
PLAGIDLD	Coefficient for the length dependence of AGIDL for drain side	A/V^3	0
PLALP	Coefficient for the length dependence of ALP	—	0
PLALP1	Coefficient for the length dependence of ALP1	V	0
PLALP2	Coefficient for the length dependence of ALP2	V^{-1}	0
PLAX	Coefficient for the length dependence of AX	—	0
PLBETN	Coefficient for the length dependence of BETN	$m^2/(Vs)$	0
PLBETNEDGE	Coefficient for the length dependence of BETNEDGE	$m^2/(Vs)$	0
PLCF	Coefficient for the length dependence of CF	—	0
PLCFEDGE	Coefficient for the length dependence of CFEDGE	—	0
PLCFR	Coefficient for the length dependence of CFR	F	0
PLCFRD	Coefficient for the length dependence of CFR for drain side	F	0
PLCGBOV	Coefficient for the length dependence of CGBOV	F	0
PLCGOV	Coefficient for the length dependence of CGOV	F	0
PLCGOVD	Coefficient for the length dependence of CGOV for drain side	F	0
PLCOX	Coefficient for the length dependence of COX	F	0
PLCS	Coefficient for the length dependence of CS	—	0
PLCT	Coefficient for the length dependence of CT	—	0
PLCTEDGE	Coefficient for the length dependence of CTEDGE	—	0
PLDELVTAC	Coefficient for the length dependence of DELVTAC	V	0

Table 2-121. PSP103VA MOSFET Device Model Parameters

Parameter	Description	Units	Default
PLDPHIB	Coefficient for the length dependence of DPHIB	V	0
PLDPHIBEDGE	Coefficient for the length dependence of DPHIBEDGE	V	0
PLFACNEFFAC	Coefficient for the length dependence of FACNEFFAC	—	0
PLFNTEXC	Coefficient for the length dependence of FNTEXC	—	0
PLGFACNUD	Coefficient for the length dependence of GFACNUD	—	0
PLIGINV	Coefficient for the length dependence of IGINV	A	0
PLIGOV	Coefficient for the length dependence of IGOV	A	0
PLIGOVD	Coefficient for the length dependence of IGOV for drain side	A	0
PLKUOWE	Coefficient for the length dependence part of KUOWE	—	0
PLKVTHOWE	Coefficient for the length dependence part of KVTHOWE	—	0
PLMUE	Coefficient for the length dependence of MUE	m/V	0
PLNEFF	Coefficient for the length dependence of NEFF	m ⁻³	0
PLNEFFEDGE	Coefficient for the length dependence of NEFFEDGE	m ⁻³	0
PLNFA	Coefficient for the length dependence of NFA	—	0
PLNFAEDGE	Coefficient for the length dependence of NFAEDGE	—	0
PLNFB	Coefficient for the length dependence of NFB	—	0
PLNFBEDGE	Coefficient for the length dependence of NFBEDGE	—	0
PLNFC	Coefficient for the length dependence of NFC	V ⁻¹	0
PLNFCEDGE	Coefficient for the length dependence of NFCEDGE	V ⁻¹	0
PLNOV	Coefficient for the length dependence of NOV	m ⁻³	0
PLNOVD	Coefficient for the length dependence of NOV for drain side	m ⁻³	0
PLNP	Coefficient for the length dependence of NP	m ⁻³	0
PLPSCE	Coefficient for the length dependence of PSCE	—	0
PLPSCEEDGE	Coefficient for the length dependence of PSCEEDGE	—	0
PLRS	Coefficient for the length dependence of RS	Ω	0
PLSTBET	Coefficient for the length dependence of STBET	—	0
PLSTBETEDGE	Coefficient for the length dependence of STBETEDGE	—	0
PLSTTHESAT	Coefficient for the length dependence of STTHESAT	—	0
PLSTVFB	Coefficient for the length dependence of STVFB	V/K	0
PLSTVFBEDGE	Coefficient for the length dependence of STVFBEDGE	V/K	0
PLTHESAT	Coefficient for the length dependence of THESAT	V ⁻¹	0
PLTHESATB	Coefficient for the length dependence of THESATB	V ⁻¹	0

Table 2-121. PSP103VA MOSFET Device Model Parameters

Parameter	Description	Units	Default
PLTHESATG	Coefficient for the length dependence of THESATG	V^{-1}	0
PLVFB	Coefficient for the length dependence of VFB	V	0
PLWA1	Coefficient for the length times width dependence of A1	—	0
PLWA3	Coefficient for the length times width dependence of A3	—	0
PLWA4	Coefficient for the length times width dependence of A4	$V^{-1/2}$	0
PLWAGIDL	Coefficient for the length times width dependence of AGIDL	A/V^3	0
PLWAGIDLD	Coefficient for the length times width dependence of AGIDL for drain side	A/V^3	0
PLWALP	Coefficient for the length times width dependence of ALP	—	0
PLWALP1	Coefficient for the length times width dependence of ALP1	V	0
PLWALP2	Coefficient for the length times width dependence of ALP2	V^{-1}	0
PLWAX	Coefficient for the length times width dependence of AX	—	0
PLWBETN	Coefficient for the length times width dependence of BETN	$m^2/(Vs)$	0
PLWBETNEDGE	Coefficient for the length times width dependence of BETNEDGE	$m^2/(Vs)$	0
PLWCF	Coefficient for the length times width dependence of CF	—	0
PLWCFEDGE	Coefficient for the length times width dependence of CFEDGE	—	0
PLWCFR	Coefficient for the length times width dependence of CFR	F	0
PLWCFRD	Coefficient for the length times width dependence of CFR for drain side	F	0
PLWCGBOV	Coefficient for the length times width dependence of CGBOV	F	0
PLWCGOV	Coefficient for the length times width dependence of CGOV	F	0
PLWCGOVD	Coefficient for the length times width dependence of CGOV for drain side	F	0
PLWCOX	Coefficient for the length times width dependence of COX	F	0

Table 2-121. PSP103VA MOSFET Device Model Parameters

Parameter	Description	Units	Default
PLWCS	Coefficient for the length times width dependence of CS	—	0
PLWCT	Coefficient for the length times width dependence of CT	—	0
PLWCTEDGE	Coefficient for the length times width dependence of CTEDGE	—	0
PLWDELVTAC	Coefficient for the length times width dependence of DELVTAC	V	0
PLWDPHIB	Coefficient for the length times width dependence of DPHIB	V	0
PLWDPHIBEDGE	Coefficient for the length times width dependence of DPHIBEDGE	V	0
PLWFACNEFFAC	Coefficient for the length times width dependence of FACNEFFAC	—	0
PLWFNTEXC	Coefficient for the length times width dependence of FNTEXC	—	0
PLWGFACNUD	Coefficient for the length times width dependence of GFACNUD	—	0
PLWIGINV	Coefficient for the length times width dependence of IGINV	A	0
PLWIGOV	Coefficient for the length times width dependence of IGOV	A	0
PLWIGOVD	Coefficient for the length times width dependence of IGOV for drain side	A	0
PLWKUOWE	Coefficient for the length times width dependence part of KUOWE	—	0
PLWKVTHOWE	Coefficient for the length times width dependence part of KVTHOWE	—	0
PLWMUE	Coefficient for the length times width dependence of MUE	m/V	0
PLWNEFF	Coefficient for the length times width dependence of NEFF	m ⁻³	0
PLWNEFFEDGE	Coefficient for the length times width dependence of NEFFEDGE	m ⁻³	0
PLWNFA	Coefficient for the length times width dependence of NFA	—	0
PLWNFAEDGE	Coefficient for the length times width dependence of NFAEDGE	—	0
PLWNFB	Coefficient for the length times width dependence of NFB	—	0
PLWNFBEDGE	Coefficient for the length times width dependence of NFBEDGE	—	0

Table 2-121. PSP103VA MOSFET Device Model Parameters

Parameter	Description	Units	Default
PLWNFC	Coefficient for the length times width dependence of NFC	V ⁻¹	0
PLWNFCEDGE	Coefficient for the length times width dependence of NFCEDGE	V ⁻¹	0
PLWNOV	Coefficient for the length times width dependence of NOV	m ⁻³	0
PLWNOVD	Coefficient for the length times width dependence of NOV for drain side	m ⁻³	0
PLWNP	Coefficient for the length times width dependence of NP	m ⁻³	0
PLWPSCE	Coefficient for the length times width dependence of PSCE	—	0
PLWPSCEEDGE	Coefficient for the length times width dependence of PSCEEDGE	—	0
PLWRS	Coefficient for the length times width dependence of RS	Ω	0
PLWSTBET	Coefficient for the length times width dependence of STBET	—	0
PLWSTBETEDGE	Coefficient for the length times width dependence of STBETEDGE	—	0
PLWSTTHESAT	Coefficient for the length times width dependence of STTHESAT	—	0
PLWSTVFB	Coefficient for the length times width dependence of STVFB	V/K	0
PLWSTVFBEDGE	Coefficient for the length times width dependence of STVFBEDGE	V/K	0
PLWTHESAT	Coefficient for the length times width dependence of THESAT	V ⁻¹	0
PLWTHESATB	Coefficient for the length times width dependence of THESATB	V ⁻¹	0
PLWTHESATG	Coefficient for the length times width dependence of THESATG	V ⁻¹	0
PLWVFB	Coefficient for the length times width dependence of VFB	V	0
PLWXCOR	Coefficient for the length times width dependence of XCOR	V ⁻¹	0
PLXCOR	Coefficient for the length dependence of XCOR	V ⁻¹	0
POA1	Coefficient for the geometry independent part of A1	—	1
POA2	Coefficient for the geometry independent part of A2	V	10
POA3	Coefficient for the geometry independent part of A3	—	1
POA4	Coefficient for the geometry independent part of A4	V ^{-1/2}	0

Table 2-121. PSP103VA MOSFET Device Model Parameters

Parameter	Description	Units	Default
POAGIDL	Coefficient for the geometry independent part of AGIDL	A/V^3	0
POAGIDLD	Coefficient for the geometry independent part of AGIDL for drain side	A/V^3	0
POALP	Coefficient for the geometry independent part of ALP	—	0.01
POALP1	Coefficient for the geometry independent part of ALP1	V	0
POALP2	Coefficient for the geometry independent part of ALP2	V^{-1}	0
POAX	Coefficient for the geometry independent part of AX	—	3
POBETN	Coefficient for the geometry independent part of BETN	$m^2/(Vs)$	0.07
POBETNEDGE	Coefficient for the geometry independent part of BETNEDGE	$m^2/(Vs)$	0.0005
POBGIDL	Coefficient for the geometry independent part of BGIDL	V	41
POBGIDLD	Coefficient for the geometry independent part of BGIDL for drain side	V	41
POCF	Coefficient for the geometry independent part of CF	—	0
POCFB	Coefficient for the geometry independent part of CFB	V^{-1}	0
POCFBEDGE	Coefficient for the geometry independent part of CFBEDGE	V^{-1}	0
POCFD	Coefficient for the geometry independent part of CFD	V^{-1}	0
POCFDEEDGE	Coefficient for the geometry independent part of CFDEEDGE	V^{-1}	0
POCFEDGE	Coefficient for the geometry independent part of CFEDGE	—	0
POCFR	Coefficient for the geometry independent part of CFR	F	0
POCFRD	Coefficient for the geometry independent part of CFR for drain side	F	0
POCGBOV	Coefficient for the geometry independent part of CGBOV	F	0
POCGIDL	Coefficient for the geometry independent part of CGIDL	—	0
POCGIDLD	Coefficient for the geometry independent part of CGIDL for drain side	—	0
POCGOV	Coefficient for the geometry independent part of CGOV	F	1e-15
POCGOVD	Coefficient for the geometry independent part of CGOV for drain side	F	1e-15

Table 2-121. PSP103VA MOSFET Device Model Parameters

Parameter	Description	Units	Default
POCHIB	Coefficient for the geometry independent part of CHIB	V	3.1
POCOX	Coefficient for the geometry independent part of COX	F	1e-14
POCS	Coefficient for the geometry independent part of CS	—	0
POCT	Coefficient for the geometry independent part of CT	—	0
POCTEDGE	Coefficient for the geometry independent part of CTEDGE	—	0
PODELVTAC	Coefficient for the geometry independent part of DELVTAC	V	0
PODNSUB	Coefficient for the geometry independent part of DNSUB	V ⁻¹	0
PODPHIB	Coefficient for the geometry independent part of DPHIB	V	0
PODPHIBEDGE	Coefficient for the geometry independent part of DPHIBEDGE	V	0
PODVSBNUD	Coefficient for the geometry independent part of DVSBNUD	V	1
POEF	Coefficient for the flicker noise frequency exponent	—	1
POEFEDGE	Coefficient for the geometry independent part of EFEDGE	—	1
POEPSROX	Coefficient for the geometry independent part of EPSOX	—	3.9
POFACNEFFAC	Coefficient for the geometry independent part of FACNEFFAC	—	1
POFETA	Coefficient for the geometry independent part of FETA	—	1
POFNT	Coefficient for the geometry independent part of FNT	—	1
POFNTEGE	Coefficient for the geometry independent part of FNTEGE	—	1
POFNTEXC	Coefficient for the geometry independent part of FNTEXC	—	0
POGC2	Coefficient for the geometry independent part of GC2	—	0.375
POGC3	Coefficient for the geometry independent part of GC3	—	0.063
POGCO	Coefficient for the geometry independent part of GCO	—	0
POGFACNUD	Coefficient for the geometry independent part of GFACNUD	—	1
POIGINV	Coefficient for the geometry independent part of IGINV	A	0
POIGOV	Coefficient for the geometry independent part of IGOV	A	0

Table 2-121. PSP103VA MOSFET Device Model Parameters

Parameter	Description	Units	Default
POIGOVD	Coefficient for the geometry independent part of IGOV for drain side	A	0
POKUOWE	Coefficient for the geometry independent part of KUOWE	—	0
POKVTHOWE	Coefficient for the geometry independent part of KVTHOWE	—	0
POMUE	Coefficient for the geometry independent part of MUE	m/V	0.5
PONEFF	Coefficient for the geometry independent part of NEFF	m ⁻³	5e+23
PONEFFEDGE	Coefficient for the geometry independent part of NEFFEDGE	m ⁻³	5e+23
PONFA	Coefficient for the geometry independent part of NFA	—	8e+22
PONFAEDGE	Coefficient for the geometry independent part of NFAEDGE	—	8e+22
PONFB	Coefficient for the geometry independent part of NFB	—	3e+07
PONFBEDGE	Coefficient for the geometry independent part of NFBEDGE	—	3e+07
PONFC	Coefficient for the geometry independent part of NFC	V ⁻¹	0
PONFCEDGE	Coefficient for the geometry independent part of NFCEDGE	V ⁻¹	0
PONOV	Coefficient for the geometry independent part of NOV	m ⁻³	5e+25
PONOVD	Coefficient for the geometry independent part of NOV for drain side	m ⁻³	5e+25
PONP	Coefficient for the geometry independent part of NP	m ⁻³	1e+26
PONSLP	Coefficient for the geometry independent part of NSLP	V	0.05
POPSCE	Coefficient for the geometry independent part of PSCE	—	0
POPSCEB	Coefficient for the geometry independent part of PSCEB	V ⁻¹	0
POPSCEBEDGE	Coefficient for the geometry independent part of PSCEBEDGE	V ⁻¹	0
POPSCED	Coefficient for the geometry independent part of PSCED	V ⁻¹	0
POPSCEDEEDGE	Coefficient for the geometry independent part of PSCEDEDGE	V ⁻¹	0
POPSCEEDGE	Coefficient for the geometry independent part of PSCEEDGE	—	0
PORS	Coefficient for the geometry independent part of RS	Ω	30
PORSB	Coefficient for the geometry independent part of RSB	V ⁻¹	0

Table 2-121. PSP103VA MOSFET Device Model Parameters

Parameter	Description	Units	Default
PORSG	Coefficient for the geometry independent part of RSG	V ⁻¹	0
POSTA2	Coefficient for the geometry independent part of STA2	V	0
POSTBET	Coefficient for the geometry independent part of STBET	—	1
POSTBETEDGE	Coefficient for the geometry independent part of STBETEDGE	—	1
POSTBGIDL	Coefficient for the geometry independent part of STBGIDL	V/K	0
POSTBGIDLD	Coefficient for the geometry independent part of STBGIDL for drain side	V/K	0
POSTCS	Coefficient for the geometry independent part of STCS	—	0
POSTIG	Coefficient for the geometry independent part of STIG	—	2
POSTMUE	Coefficient for the geometry independent part of STMUE	—	0
POSTRS	Coefficient for the geometry independent part of STRS	—	1
POSTTHEMU	Coefficient for the geometry independent part of STTHEMU	—	1.5
POSTTHESAT	Coefficient for the geometry independent part of STTHESAT	—	1
POSTVFB	Coefficient for the geometry independent part of STVFB	V/K	0.0005
POSTVFBEDGE	Coefficient for the geometry independent part of STVFBEDGE	V/K	0
POSTXCOR	Coefficient for the geometry independent part of STXCOR	—	0
POTHEMU	Coefficient for the geometry independent part of THEMU	—	1.5
POTHEMAT	Coefficient for the geometry independent part of THESAT	V ⁻¹	1
POTHEMATB	Coefficient for the geometry independent part of THESATB	V ⁻¹	0
POTHEMATG	Coefficient for the geometry independent part of THESATG	V ⁻¹	0
POTOX	Coefficient for the geometry independent part of TOX	m	2e-09
POTOXOV	Coefficient for the geometry independent part of TOXOV	m	2e-09
POTOXOVD	Coefficient for the geometry independent part of TOXOV for drain side	m	2e-09
POVFB	Coefficient for the geometry independent part of VFB	V	-1
POVFBEDGE	Coefficient for the geometry independent part of VFBEDGE	V	-1

Table 2-121. PSP103VA MOSFET Device Model Parameters

Parameter	Description	Units	Default
POVNSUB	Coefficient for the geometry independent part of VNSUB	V	0
POVP	Coefficient for the geometry independent part of VP	V	0.05
POVSBNUD	Coefficient for the geometry independent part of VSBNUD	V	0
POXCOR	Coefficient for the geometry independent part of XCOR	V ⁻¹	0
PSCE	Subthreshold slope coefficient for short channel transistor	—	0
PSCEB	Bulk voltage dependence parameter of subthreshold slope coefficient for short channel transistor	V ⁻¹	0
PSCEBEDGE	Bulk voltage dependence parameter of subthreshold slope coefficient for short channel edge transistors	V ⁻¹	0
PSCEBEDGEO	Bulk voltage dependence parameter of subthreshold slope coefficient for short channel edge transistors	V ⁻¹	0
PSCEBO	Bulk voltage dependence parameter of subthreshold slope coefficient for short channel transistor	V ⁻¹	0
PSCED	Drain voltage dependence parameter of subthreshold slope coefficient for short channel transistor	V ⁻¹	0
PSCEDEDGE	Drain voltage dependence parameter of subthreshold slope coefficient for short channel edge transistors	V ⁻¹	0
PSCEDEDGEO	Drain voltage dependence parameter of subthreshold slope coefficient for short channel edge transistors	V ⁻¹	0
PSCEDO	Drain voltage dependence parameter of subthreshold slope coefficient for short channel transistor	V ⁻¹	0
PSCEEDGE	Subthreshold slope coefficient for short channel edge transistors	—	0
PSCEEDGEL	Length dependence of subthreshold slope coefficient for short channel edge transistors	—	0
PSCEEDGELEXP	Exponent for length dependence of subthreshold slope coefficient for short channel edge transistors	—	2
PSCEEDGEW	Exponent for length dependence of subthreshold slope coefficient for short channel edge transistor	—	0
PSCEL	Length dependence of subthreshold slope coefficient for short channel transistor	—	0
PSCELEXP	Exponent for length dependence of subthreshold slope coefficient for short channel transistor	—	2
PSCEW	Exponent for length dependence of subthreshold slope coefficient for short channel transistor	—	0
PSTI	Grading coefficient of STI-edge component for source-bulk junction	—	0.5

Table 2-121. PSP103VA MOSFET Device Model Parameters

Parameter	Description	Units	Default
PSTID	Grading coefficient of STI-edge component for drain-bulk junction	—	0.5
PWA1	Coefficient for the width dependence of A1	—	0
PWA3	Coefficient for the width dependence of A3	—	0
PWA4	Coefficient for the width dependence of A4	$V^{-1/2}$	0
PWAGIDL	Coefficient for the width dependence of AGIDL	A/V^3	0
PWAGIDLD	Coefficient for the width dependence of AGIDL for drain side	A/V^3	0
PWALP	Coefficient for the width dependence of ALP	—	0
PWALP1	Coefficient for the width dependence of ALP1	V	0
PWALP2	Coefficient for the width dependence of ALP2	V^{-1}	0
PWAX	Coefficient for the width dependence of AX	—	0
PWBETN	Coefficient for the width dependence of BETN	$m^2/(Vs)$	0
PWBETNEDGE	Coefficient for the width dependence of BETNEDGE	$m^2/(Vs)$	0
PWCF	Coefficient for the width dependence of CF	—	0
PWCFEDGE	Coefficient for the width dependence of CFEDGE	—	0
PWCFR	Coefficient for the width dependence of CFR	F	0
PWCFRD	Coefficient for the width dependence of CFR for drain side	F	0
PWCGBOV	Coefficient for the width dependence of CGBOV	F	0
PWCGOV	Coefficient for the width dependence of CGOV	F	0
PWCGOVD	Coefficient for the width dependence of CGOV for drain side	F	0
PWCOX	Coefficient for the width dependence of COX	F	0
PWCS	Coefficient for the width dependence of CS	—	0
PWCT	Coefficient for the width dependence of CT	—	0
PWCTEDGE	Coefficient for the width dependence of CTEDGE	—	0
PWDELVTAC	Coefficient for the width dependence of DELVTAC	V	0
PWDPHIB	Coefficient for the width dependence of DPHIB	V	0
PWDPHIBEDGE	Coefficient for the width dependence of DPHIBEDGE	V	0
PWFACNEFFAC	Coefficient for the width dependence of FACNEFFAC	—	0
PWFNTEXC	Coefficient for the width dependence of FNTEXC	—	0
PWGFACTUD	Coefficient for the width dependence of GFACNUD	—	0
PWIGINV	Coefficient for the width dependence of IGINV	A	0
PWIGOV	Coefficient for the width dependence of IGOV	A	0
PWIGOVD	Coefficient for the width dependence of IGOV for drain side	A	0

Table 2-121. PSP103VA MOSFET Device Model Parameters

Parameter	Description	Units	Default
PWKUOWE	Coefficient for the width dependence part of KUOWE	—	0
PWKVTHOWE	Coefficient for the width dependence part of KVTHOWE	—	0
PWMUE	Coefficient for the width dependence of MUE	m/V	0
PWNEFF	Coefficient for the width dependence of NEFF	m ⁻³	0
PWNEFFEDGE	Coefficient for the width dependence of NEFFEDGE	m ⁻³	0
PWNFA	Coefficient for the width dependence of NFA	—	0
PWNFAEDGE	Coefficient for the width dependence of NFAEDGE	—	0
PWNFB	Coefficient for the width dependence of NFB	—	0
PWNFBEDGE	Coefficient for the width dependence of NFBEDGE	—	0
PWNFC	Coefficient for the width dependence of NFC	V ⁻¹	0
PWNFCEDGE	Coefficient for the width dependence of NFCEDGE	V ⁻¹	0
PWNOV	Coefficient for the width dependence of NOV	m ⁻³	0
PWNOVD	Coefficient for the width dependence of NOV for drain side	m ⁻³	0
PWNP	Coefficient for the width dependence of NP	m ⁻³	0
PWPSCE	Coefficient for the width dependence of PSCE	—	0
PWPSCEEDGE	Coefficient for the width dependence of PSCEEDGE	—	0
PWRS	Coefficient for the width dependence of RS	Ω	0
PWSTBET	Coefficient for the width dependence of STBET	—	0
PWSTBETEDGE	Coefficient for the width dependence of STBETEDGE	—	0
PWSTTHESAT	Coefficient for the width dependence of STTHESAT	—	0
PWSTVFB	Coefficient for the width dependence of STVFB	V/K	0
PWSTVFBEDGE	Coefficient for the width dependence of STVFBEDGE	V/K	0
PWTHESAT	Coefficient for the width dependence of THESAT	V ⁻¹	0
PWTHESATB	Coefficient for the width dependence of THESATB	V ⁻¹	0
PWTHESATG	Coefficient for the width dependence of THESATG	V ⁻¹	0
PWVFB	Coefficient for the width dependence of VFB	V	0
PWXCOR	Coefficient for the width dependence of XCOR	V ⁻¹	0
QMC	Quantum-mechanical correction factor	—	1
RBULK	Bulk resistance between node BP and BI	Ω	0
RBULK0	Bulk resistance between node BP and BI	Ω	0
RDE	External drain resistance	Ω	0
RG	Gate resistance	Ω	0
RGO	Gate resistance	Ω	0
RINT	Contact resistance between silicide and ploy	Ω m ²	0

Table 2-121. PSP103VA MOSFET Device Model Parameters

Parameter	Description	Units	Default
RJUND	Drain-side bulk resistance between node BI and BD	Ω	0
RJUNDO	Drain-side bulk resistance between node BI and BD	Ω	0
RJUNS	Source-side bulk resistance between node BI and BS	Ω	0
RJUNSO	Source-side bulk resistance between node BI and BS	Ω	0
RS	Series resistance at TR	Ω	30
RSB	Back-bias dependence of series resistance	V^{-1}	0
RSBO	Back-bias dependence of series resistance	V^{-1}	0
RSE	External source resistance	Ω	0
RSG	Gate-bias dependence of series resistance	V^{-1}	0
RSGO	Gate-bias dependence of series resistance	V^{-1}	0
RSH	Sheet resistance of source diffusion	Ω/\square	0
RSHD	Sheet resistance of drain diffusion	Ω/\square	0
RSHG	Gate electrode diffusion sheet resistance	Ω/\square	0
RSW1	Source/drain series resistance for 1 um wide channel at TR	Ω	50
RSW2	Higher-order width scaling of RS	—	0
RVPOLY	Vertical poly resistance	$\Omega\ m^2$	0
RWELL	Well resistance between node BI and B	Ω	0
RWELLO	Well resistance between node BI and B	Ω	0
SAREF	Reference distance between OD-edge and poly from one side	m	1e-06
SBREF	Reference distance between OD-edge and poly from other side	m	1e-06
SCREF	Distance between OD-edge and well edge of a reference device	m	1e-06
STA2	Temperature dependence of A2	V	0
STA20	Temperature dependence of A2	V	0
STBET	Temperature dependence of BETN	—	1
STBETEDGE	Temperature dependence of BETNEDGE	—	1
STBETEDGEL	Length dependence of temperature dependence of BETNEDGE	—	0
STBETEDGELW	Area dependence of temperature dependence of BETNEDGE	—	0
STBETEDGE0	Geometry independent temperature dependence of BETNEDGE	—	1
STBETEDGEW	Width dependence of temperature dependence of BETNEDGE	—	0

Table 2-121. PSP103VA MOSFET Device Model Parameters

Parameter	Description	Units	Default
STBETL	Length dependence of temperature dependence of BETN	—	0
STBETLW	Area dependence of temperature dependence of BETN	—	0
STBETO	Geometry independent temperature dependence of BETN	—	1
STBETW	Width dependence of temperature dependence of BETN	—	0
STBGIDL	Temperature dependence of BGIDL	V/K	0
STBGIDLD	Temperature dependence of BGIDL for drain side	V/K	0
STBGIDLDO	Temperature dependence of BGIDL for drain side	V/K	0
STBGIDLO	Temperature dependence of BGIDL	V/K	0
STCS	Temperature dependence of CS	—	0
STCSO	Temperature dependence of CS	—	0
STETA0	Eta0 shift factor related to VTHO change	m	0
STFBBTBOT	Temperature scaling parameter for band-to-band tunneling of bottom component for source-bulk junction	1/K	-0.001
STFBBTBOTD	Temperature scaling parameter for band-to-band tunneling of bottom component for drain-bulk junction	1/K	-0.001
STFBBTGAT	Temperature scaling parameter for band-to-band tunneling of gate-edge component for source-bulk junction	1/K	-0.001
STFBBTGATD	Temperature scaling parameter for band-to-band tunneling of gate-edge component for drain-bulk junction	1/K	-0.001
STFBBTSTI	Temperature scaling parameter for band-to-band tunneling of STI-edge component for source-bulk junction	1/K	-0.001
STFBBTSTID	Temperature scaling parameter for band-to-band tunneling of STI-edge component for drain-bulk junction	1/K	-0.001
STIG	Temperature dependence of IGINV and IGOV	—	2
STIGO	Temperature dependence of IGINV and IGOV	—	2
STMUE	Temperature dependence of MUE	—	0
STMUEO	Temperature dependence of MUE	—	0
STRS	Temperature dependence of RS	—	1
STRSO	Temperature dependence of RS	—	1
STTHEMU	Temperature dependence of THEMU	—	1.5

Table 2-121. PSP103VA MOSFET Device Model Parameters

Parameter	Description	Units	Default
STTHEMUO	Temperature dependence of THEMU	—	1.5
STTHESAT	Temperature dependence of THESAT	—	1
STTHESATL	Length dependence of temperature dependence of THESAT	—	0
STTHESATLW	Area dependence of temperature dependence of THESAT	—	0
STTHESATO	Geometry independent temperature dependence of THESAT	—	1
STTHESATW	Width dependence of temperature dependence of THESAT	—	0
STVFB	Temperature dependence of VFB	V/K	0.0005
STVFBEDGE	Temperature dependence of VFBEDGE	V/K	0.0005
STVFBEDGEL	Length dependence of temperature dependence of VFBEDGE	V/K	0
STVFBEDGELW	Area dependence of temperature dependence of VFBEDGE	V/K	0
STVFBEDGEO	Geometry-independent temperature dependence of VFBEDGE	V/K	0.0005
STVFBEDGEW	Width dependence of temperature dependence of VFBEDGE	V/K	0
STVFB	Length dependence of temperature dependence of VFB	V/K	0
STVFBWL	Area dependence of temperature dependence of VFB	V/K	0
STVFB	Geometry-independent temperature dependence of VFB	V/K	0.0005
STVFBW	Width dependence of temperature dependence of VFB	V/K	0
STXCOR	Temperature dependence of XCOR	—	0
STXCORO	Temperature dependence of XCOR	—	0
SWDELVTAC	Flag for separate capacitance calculation; 0=off, 1=on	—	0
SWEDGE	Flag for drain current of edge transistors; 0=off, 1=on	—	0
SWGEO	Flag for geometrical model, 0=local, 1=global, 2=binning	—	1
SWGIDL	Flag for GIDL current, 0=turn off IGIDL	—	0
SWIGATE	Flag for gate current, 0=turn off IG	—	0
SWIGN	Flag for induced gate noise; 0=off, 1=on	—	1
SWIMPACT	Flag for impact ionization current, 0=turn off II	—	0
SWJUNASYM	Flag for asymmetric junctions; 0=symmetric, 1=asymmetric	—	0
SWJUNCAP	Flag for juncap, 0=turn off juncap	—	0

Table 2-121. PSP103VA MOSFET Device Model Parameters

Parameter	Description	Units	Default
SWJUNEXP	Flag for JUNCAP-express; 0=full model, 1=express model	—	0
SWNUD	Flag for NUD-effect; 0=off, 1=on, 2=on+CV-correction	—	0
THEMU	Mobility reduction exponent at TR	—	1.5
THEMUO	Mobility reduction exponent at TR	—	1.5
THESAT	Velocity saturation parameter at TR	V ⁻¹	1
THESATB	Back-bias dependence of velocity saturation	V ⁻¹	0
THESATBO	Back-bias dependence of velocity saturation	V ⁻¹	0
THESATG	Gate-bias dependence of velocity saturation	V ⁻¹	0
THESATGO	Gate-bias dependence of velocity saturation	V ⁻¹	0
THESATL	Length dependence of THESAT	V ⁻¹	0.05
THESATLEXP	Exponent for length dependence of THESAT	—	1
THESATLW	Area dependence of velocity saturation parameter	—	0
THESATO	Geometry independent velocity saturation parameter at TR	V ⁻¹	0
THESATW	Width dependence of velocity saturation parameter	—	0
TKUO	Temperature dependence of KUO	—	0
TOX	Gate oxide thickness	m	2e-09
TOXO	Gate oxide thickness	m	2e-09
TOXOV	Overlap oxide thickness	m	2e-09
TOXOVD	Overlap oxide thickness for drain side	m	2e-09
TOXOVDO	Overlap oxide thickness for drain side	m	2e-09
TOXOVO	Overlap oxide thickness	m	2e-09
TR	nominal (reference) temperature	°C	21
TRJ	Reference temperature	°C	21
TYPE	Channel type parameter, +1=NMOS -1=PMOS	—	1
UO	Zero-field mobility at TR	m ² /(Vs)	0.05
VBIRBOT	Built-in voltage at the reference temperature of bottom component for source-bulk junction	V	1
VBIRBOTD	Built-in voltage at the reference temperature of bottom component for drain-bulk junction	V	1
VBIRGAT	Built-in voltage at the reference temperature of gate-edge component for source-bulk junction	V	1
VBIRGATD	Built-in voltage at the reference temperature of gate-edge component for drain-bulk junction	V	1
VBIRSTI	Built-in voltage at the reference temperature of STI-edge component for source-bulk junction	V	1

Table 2-121. PSP103VA MOSFET Device Model Parameters

Parameter	Description	Units	Default
VBIRSTID	Built-in voltage at the reference temperature of STI-edge component for drain-bulk junction	V	1
VBRBOT	Breakdown voltage of bottom component for source-bulk junction	V	10
VBRBOTD	Breakdown voltage of bottom component for drain-bulk junction	V	10
VBRGAT	Breakdown voltage of gate-edge component for source-bulk junction	V	10
VBRGATD	Breakdown voltage of gate-edge component for drain-bulk junction	V	10
VBRSTI	Breakdown voltage of STI-edge component for source-bulk junction	V	10
VBRSTID	Breakdown voltage of STI-edge component for drain-bulk junction	V	10
VFB	Flat band voltage at TR	V	-1
VFEDGE	Flat band voltage of edge transistors at TR	V	-1
VFEDGE0	Geometry-independent flat-band voltage of edge transistors at TR	V	-1
VFBL	Length dependence of flat-band voltage	V	0
VFBLW	Area dependence of flat-band voltage	V	0
VFBO	Geometry-independent flat-band voltage at TR	V	-1
VFBW	Width dependence of flat-band voltage	V	0
VJUNREF	Typical maximum source-bulk junction voltage; usually about 2*VSUP	V	2.5
VJUNREFD	Typical maximum drain-bulk junction voltage; usually about 2*VSUP	V	2.5
VNSUB	Effective doping bias-dependence parameter	V	0
VNSUBO	Effective doping bias-dependence parameter	V	0
VP	CLM logarithm dependence factor	V	0.05
VPO	CLM logarithmic dependence parameter	V	0.05
VSBNUD	Lower Vsb value for NUD-effect	V	0
VSBNUDO	Lower Vsb value for NUD-effect	V	0
WBET	Characteristic width for width scaling of BETN	m	1e-09
WEB	Coefficient for SCB	—	0
WEC	Coefficient for SCC	—	0
WEDGE	Electrical width of edge transistor per side	m	1e-08
WEDGEW	Width dependence of edge WEDGE	—	0
WKUO	Width dependence of KUO	—	0
WKVTHO	Width dependence of KVTHO	—	0

Table 2-121. PSP103VA MOSFET Device Model Parameters

Parameter	Description	Units	Default
WLOD	Width parameter	m	0
WLODKUO	Width parameter for UO stress effect	—	0
WLODVTH	Width parameter for VTH-stress effect	—	0
WMAX	Dummy parameter to label binning set	m	1
WMIN	Dummy parameter to label binning set	m	0
WOT	Effective channel width reduction per side	m	0
WSEG	Char. length of segregation of background doping NSUBO	m	1e-08
WSEGP	Char. length of segregation of pocket doping NPCK	m	1e-08
WVARL	Length dependence of WVAR	—	0
WVARO	Geom. independent difference between actual and programmed field-oxide opening	m	0
WVARW	Width dependence of WVAR	—	0
XCOR	Non-universality factor	V ⁻¹	0
XCORL	Length dependence of non-universality parameter	—	0
XCORLW	Area dependence of non-universality parameter	—	0
XCORO	Geometry independent non-universality parameter	V ⁻¹	0
XCORW	Width dependence of non-universality parameter	—	0
XJUNGAT	Junction depth of gate-edge component for source-bulk junction	m	1e-07
XJUNGATD	Junction depth of gate-edge component for drain-bulk junction	m	1e-07
XJUNSTI	Junction depth of STI-edge component for source-bulk junction	m	1e-07
XJUNSTID	Junction depth of STI-edge component for drain-bulk junction	m	1e-07

Table 2-122. MOSFET level 103 Output Variables

Parameter	Description	Units	Default
ctype	Flag for channel type		none
sdint	Flag for source-drain interchange		none
ise	Total source current	A	none
ige	Total gate current	A	none
ide	Total drain current	A	none
ibe	Total bulk current	A	none
ids	Drain current, excl. edge transistor currents, avalanche, tunnel, GISL, GIDL, and junction currents	A	none

Table 2-122. MOSFET level 103 Output Variables

Parameter	Description	Units	Default
idb	Drain to bulk current	A	none
isb	Source to bulk current	A	none
igs	Gate-source tunneling current	A	none
igd	Gate-drain tunneling current	A	none
igb	Gate-bulk tunneling current	A	none
idedge	Drain current of edge transistors	A	none
igcs	Gate-channel tunneling current (source component)	A	none
igcd	Gate-channel tunneling current (drain component)	A	none
iavl	Substrate current due to weak avalanche	A	none
igisl	Gate-induced source leakage current	A	none
igidl	Gate-induced drain leakage current	A	none
ijs	Total source junction current	A	none
ijsbot	Source junction current (bottom component)	A	none
ijsgat	Source junction current (gate-edge component)	A	none
ijssti	Source junction current (STI-edge component)	A	none
ijd	Total drain junction current	A	none
ijdbot	Drain junction current (bottom component)	A	none
ijdgat	Drain junction current (gate-edge component)	A	none
ijdsti	Drain junction current (STI-edge component)	A	none
vds	Drain-source voltage	V	none
vgs	Gate-source voltage	V	none
vsb	Source-bulk voltage	V	none
vto	Zero-bias threshold voltage	V	none
vts	Threshold voltage including back bias effects	V	none
vth	Threshold voltage including back bias and drain bias effects	V	none
vgt	Effective gate drive voltage including back bias and drain bias effects	V	none
vdss	Drain saturation voltage at actual bias	V	none
vsat	Saturation limit		none
gm	Transconductance	Ω^{-1}	none
gmb	Substrate transconductance	Ω^{-1}	none
gds	Output conductance	Ω^{-1}	none
gjs	Source junction conductance	Ω^{-1}	none
gjd	Drain junction conductance	Ω^{-1}	none
cdd	Drain capacitance	F	none

Table 2-122. MOSFET level 103 Output Variables

Parameter	Description	Units	Default
cdg	Drain-gate capacitance	F	none
cds	Drain-source capacitance	F	none
cdb	Drain-bulk capacitance	F	none
cgd	Gate-drain capacitance	F	none
cgg	Gate capacitance	F	none
cgs	Gate-source capacitance	F	none
cgb	Gate-bulk capacitance	F	none
csd	Source-drain capacitance	F	none
csg	Source-gate capacitance	F	none
css	Source capacitance	F	none
csb	Source-bulk capacitance	F	none
cbd	Bulk-drain capacitance	F	none
cbg	Bulk-gate capacitance	F	none
cbs	Bulk-source capacitance	F	none
cbb	Bulk capacitance	F	none
cgsol	Total gate-source overlap capacitance	F	none
cgdol	Total gate-drain overlap capacitance	F	none
cjs	Total source junction capacitance	F	none
cjsbot	Source junction capacitance (bottom component)	F	none
cjsgat	Source junction capacitance (gate-edge component)	F	none
cjssti	Source junction capacitance (STI-edge component)	F	none
cjd	Total drain junction capacitance	F	none
cjdbot	Drain junction capacitance (bottom component)	F	none
cjdgat	Drain junction capacitance (gate-edge component)	F	none
cjdsti	Drain junction capacitance (STI-edge component)	F	none
weff	Effective channel width for geometrical models	m	none
leff	Effective channel length for geometrical models	m	none
u	Transistor gain		none
rout	Small-signal output resistance	Ohm	none
vearly	Equivalent Early voltage	V	none
beff	Gain factor	A/V ²	none
fug	Unity gain frequency at actual bias	Hz	none
rg	Gate resistance	Ohm	none
sfl	Flicker noise current spectral density at 1 Hz	A ² /Hz	none
sqrtsff	Input-referred RMS white noise voltage spectral density at 1 kHz	V/sqrt(Hz)	none

Table 2-122. MOSFET level 103 Output Variables

Parameter	Description	Units	Default
sqrtsfw	Input-referred RMS white noise voltage spectral density	V/sqrt(Hz)	none
sid	White noise current spectral density	A ² /Hz	none
sig	Induced gate noise current spectral density at 1 Hz	A ² /Hz	none
cigid	Imaginary part of correlation coefficient between Sig and Sid		none
fknee	Cross-over frequency above which white noise is dominant	Hz	none
sigs	Gate-source current noise spectral density	A ² /Hz	none
sigd	Gate-drain current noise spectral density	A ² /Hz	none
siavl	Impact ionization current noise spectral density	A ² /Hz	none
ssi	Total source junction current noise spectral density	A ² /Hz	none
sdi	Total drain junction current noise spectral density	A ² /Hz	none
sfledge	Flicker noise current spectral density at 1 Hz of edge transistors	A ² /Hz	none
sidedge	White noise current spectral density of edge transistors	A ² /Hz	none
lp_vfb	Local parameter VFB after T-scaling and clipping	V	none
lp_stvfb	Local parameter STVFB after clipping	V/K	none
lp_tox	Local parameter TOX after clipping	m	none
lp_epsrox	Local parameter EPSROX after clipping		none
lp_neff	Local parameter NEFF after clipping	m ⁻³	none
lp_facneffac	Local parameter FACNEFFAC after clipping		none
lp_gfacnud	Local parameter GFACNUD after clipping		none
lp_vsbnud	Local parameter VSBNUD after clipping	V	none
lp_dvsbnud	Local parameter DVSBNUD after clipping	V	none
lp_vnsub	Local parameter VNSUB after clipping	V	none
lp_nslp	Local parameter NSLP after clipping	V	none
lp_dnsb	Local parameter DNSUB after clipping	V ⁻¹	none
lp_dphib	Local parameter DPHIB after clipping	V	none
lp_delvtac	Local parameter DELVTAC after clipping	V	none
lp_np	Local parameter NP after clipping	m ⁻³	none
lp_ct	Local parameter CT after clipping		none
lp_toxov	Local parameter TOXOV after clipping	m	none
lp_toxovd	Local parameter TOXOVD after clipping	m	none
lp_nov	Local parameter NOV after clipping	m ⁻³	none
lp_novd	Local parameter NOVD after clipping	m ⁻³	none

Table 2-122. MOSFET level 103 Output Variables

Parameter	Description	Units	Default
lp_cf	Local parameter CF after clipping		none
lp_cfd	Local parameter CFD after clipping	V ⁻¹	none
lp_cfb	Local parameter CFB after clipping	V ⁻¹	none
lp_psce	Local parameter PSCE after clipping		none
lp_psceb	Local parameter PSCEB after clipping	V ⁻¹	none
lp_psced	Local parameter PSCED after clipping	V ⁻¹	none
lp_betn	Local parameter BETN after T-scaling and clipping	m ² /(V s)	none
lp_stbet	Local parameter STBET after clipping		none
lp_mue	Local parameter MUE after T-scaling and clipping	m/V	none
lp_stmue	Local parameter STMUE after clipping		none
lp_themu	Local parameter THEMU after T-scaling and clipping		none
lp_stthemu	Local parameter STTHEMU after clipping		none
lp_cs	Local parameter CS after T-scaling and clipping		none
lp_stcs	Local parameter STCS after clipping		none
lp_xcor	Local parameter XCOR after T-scaling and clipping	V ⁻¹	none
lp_stxcor	Local parameter STXCOR after clipping		none
lp_feta	Local parameter FETA after clipping		none
lp_rs	Local parameter RS after T-scaling and clipping	Ohm	none
lp_strs	Local parameter STRS after clipping		none
lp_rsb	Local parameter RSB after clipping	V ⁻¹	none
lp_rsg	Local parameter RSG after clipping	V ⁻¹	none
lp_thesat	Local parameter THESAT after T-scaling and clipping	V ⁻¹	none
lp_stthesat	Local parameter STTHESAT after clipping		none
lp_thesatb	Local parameter THESATB after clipping	V ⁻¹	none
lp_thesatg	Local parameter THESATG after clipping	V ⁻¹	none
lp_ax	Local parameter AX after clipping		none
lp_alp	Local parameter ALP after clipping		none
lp_alp1	Local parameter ALP1 after clipping	V	none
lp_alp2	Local parameter ALP2 after clipping	V ⁻¹	none
lp_vp	Local parameter VP after clipping	V	none
lp_a1	Local parameter A1 after clipping		none
lp_a2	Local parameter A2 after T-scaling and clipping	V	none
lp_sta2	Local parameter STA2 after clipping		none
lp_a3	Local parameter A3 after clipping		none
lp_a4	Local parameter A4 after clipping	1/sqrt(V)	none
lp_gco	Local parameter GCO after clipping		none

Table 2-122. MOSFET level 103 Output Variables

Parameter	Description	Units	Default
lp_iginv	Local parameter IGINV after T-scaling and clipping	A	none
lp_igov	Local parameter IGOV after T-scaling and clipping	A	none
lp_igovd	Local parameter IGOVD after T-scaling and clipping	A	none
lp_stig	Local parameter STIG after clipping		none
lp_gc2	Local parameter GC2 after clipping		none
lp_gc3	Local parameter GC3 after clipping		none
lp_chib	Local parameter CHIB after clipping	V	none
lp_agidl	Local parameter AGIDL after clipping	A/V^3	none
lp_agidld	Local parameter AGIDLD after clipping	A/V^3	none
lp_bgidl	Local parameter BGIDL after T-scaling and clipping	V	none
lp_bgidld	Local parameter BGIDLD after T-scaling and clipping	V	none
lp_stbgidl	Local parameter STBGIDL after clipping	V/K	none
lp_stbgidld	Local parameter STBGIDLD after clipping	V/K	none
lp_cgidl	Local parameter CGIDL after clipping		none
lp_cgidld	Local parameter CGIDLD after clipping		none
lp_cox	Local parameter COX after clipping	F	none
lp_cgov	Local parameter CGOV after clipping	F	none
lp_cgovd	Local parameter CGOVD after clipping	F	none
lp_cgbov	Local parameter CGBOV after clipping	F	none
lp_cfr	Local parameter CFR after clipping	F	none
lp_cfrd	Local parameter CFRD after clipping	F	none
lp_fnt	Local parameter FNT after clipping		none
lp_fntexc	Local parameter FNTEXC after clipping		none
lp_nfa	Local parameter NFA after clipping	$1/(V\ m^4)$	none
lp_nfb	Local parameter NFB after clipping	$1/(V\ m^4)$	none
lp_nfc	Local parameter NFC after clipping	V^{-1}	none
lp_ef	Local parameter EF after clipping		none
lp_vfbedge	Local parameter VFBEDGE after T-scaling and clipping	V	none
lp_stvfbedge	Local parameter STVFBEDGE after clipping	V/K	none
lp_dphibedge	Local parameter DPHIBEDGE after clipping	V	none
lp_neffedge	Local parameter NEFFEDGE after clipping	m^{-3}	none
lp_ctedge	Local parameter CTEDGE after clipping		none
lp_betnedge	Local parameter BETNEDGE after T-scaling and clipping	$m^2/(Vs)$	none
lp_stbetedge	Local parameter STBETEDGE after clipping		none

Table 2-122. MOSFET level 103 Output Variables

Parameter	Description	Units	Default
lp_psceedge	Local parameter PSCEEDGE after clipping		none
lp_pscebedge	Local parameter PSCEBEDGE after clipping	V ⁻¹	none
lp_pscedge	Local parameter PSCEEDGE after clipping	V ⁻¹	none
lp_cfedge	Local parameter CFEDGE after clipping	V	none
lp_cfdedge	Local parameter CFEDGE after clipping	V ⁻¹	none
lp_cfbedge	Local parameter CFBEDGE after clipping	V ⁻¹	none
lp_fntedge	Local parameter FNTEDGE after clipping		none
lp_nfaedge	Local parameter NFAEDGE after clipping	1/(V m ⁴)	none
lp_nfbedge	Local parameter NFBEDGE after clipping	1/(V m ⁴)	none
lp_nfcedge	Local parameter NFCEDGE after clipping	V ⁻¹	none
lp_efedge	Local parameter EFEDGE after clipping		none
lp_rg	Local parameter RG after clipping	Ohm	none
lp_rse	Local parameter RSE after clipping	Ohm	none
lp_rde	Local parameter RDE after clipping	Ohm	none
lp_rbulk	Local parameter RBULK after clipping	Ohm	none
lp_rwell	Local parameter RWELL after clipping	Ohm	none
lp_rjuns	Local parameter RJUNS after clipping	Ohm	none
lp_rjund	Local parameter RJUND after clipping	Ohm	none
tk	Device Temperature	K	none
cjosbot	Bottom component of total zero-bias source junction capacitance at device temperature	F	none
cjossti	STI-edge component of total zero-bias source junction capacitance at device temperature	F	none
cjosgat	Gate-edge component of total zero-bias source junction capacitance at device temperature	F	none
vbisbot	Built-in voltage of source-side bottom junction at device temperature	V	none
vbissti	Built-in voltage of source-side STI-edge junction at device temperature	V	none
vbisgat	Built-in voltage of source-side gate-edge junction at device temperature	V	none
idsatsbot	Total source-side bottom junction saturation current	A	none
idsatssti	Total source-side STI-edge junction saturation current	A	none
idsatsgat	Total source-side gate-edge junction saturation current	A	none
cjosbotd	Bottom component of total zero-bias drain junction capacitance at device temperature	F	none
cjosstid	STI-edge component of total zero-bias drain junction capacitance at device temperature	F	none

Table 2-122. MOSFET level 103 Output Variables

Parameter	Description	Units	Default
cjosgatd	Gate-edge component of total zero-bias drain junction capacitance at device temperature	F	none
vbisbotd	Built-in voltage of drain-side bottom junction at device temperature	V	none
vbisstid	Built-in voltage of drain-side STI-edge junction at device temperature	V	none
vbisgatd	Built-in voltage of drain-side gate-edge junction at device temperature	V	none
idsatsbotd	Total drain-side bottom junction saturation current	A	none
idsatsstid	Total drain-side STI-edge junction saturation current	A	none
idsatsgatd	Total drain-side gate-edge junction saturation current	A	none

Table 2-123. PSP103VA MOSFET with self-heating Device Instance Parameters

Parameter	Description	Units	Default
ABDRAIN	Bottom area of drain junction	m ²	1e-12
ABSOURCE	Bottom area of source junction	m ²	1e-12
AD	Bottom area of drain junction	m ²	1e-12
AS	Bottom area of source junction	m ²	1e-12
DELVTO	Threshold voltage shift parameter	V	0
DELVTOEDGE	Threshold voltage shift parameter of edge transistor	V	0
DTA	Temperature offset w.r.t. ambient temperature	K	0
FACTUO	Zero-field mobility pre-factor	—	1
FACTUOEDGE	Zero-field mobility pre-factor of edge transistor	—	1
JW	Gate-edge length of source/drain junction	m	1e-06
L	Design length	m	1e-05
LGDRAIN	Gate-edge length of drain junction	m	1e-06
LGSOURCE	Gate-edge length of source junction	m	1e-06
LSDRAIN	STI-edge length of drain junction	m	1e-06
LSSOURCE	STI-edge length of source junction	m	1e-06
M	Alias for MULT	—	1
MULT	Number of devices in parallel	—	1
NF	Number of fingers	—	1
NGCON	Number of gate contacts	—	1
NRD	Number of squares of drain diffusion	—	0
NRS	Number of squares of source diffusion	—	0
PD	Perimeter of drain junction	m	1e-06

Table 2-123. PSP103VA MOSFET with self-heating Device Instance Parameters

Parameter	Description	Units	Default
PS	Perimeter of source junction	m	1e-06
SA	Distance between OD-edge and poly from one side	m	0
SB	Distance between OD-edge and poly from other side	m	0
SC	Distance between OD-edge and nearest well edge	m	0
SCA	Integral of the first distribution function for scattered well dopants	—	0
SCB	Integral of the second distribution function for scattered well dopants	—	0
SCC	Integral of the third distribution function for scattered well dopants	—	0
SD	Distance between neighbouring fingers	m	0
W	Design width	m	1e-05
XGW	Distance from the gate contact to the channel edge	m	1e-07

Table 2-124. PSP103VA MOSFET with self-heating Device Model Parameters

Parameter	Description	Units	Default
A1	Impact-ionization pre-factor	—	1
A1L	Length dependence of A1	—	0
A10	Geometry independent impact-ionization pre-factor	—	1
A1W	Width dependence of A1	—	0
A2	Impact-ionization exponent at TR	V	10
A20	Impact-ionization exponent at TR	V	10
A3	Saturation-voltage dependence of impact-ionization	—	1
A3L	Length dependence of A3	—	0
A30	Geometry independent saturation-voltage dependence of II	—	1
A3W	Width dependence of A3	—	0
A4	Back-bias dependence of impact-ionization	$V^{-1/2}$	0
A4L	Length dependence of A4	—	0
A40	Geometry independent back-bias dependence of II	$V^{-1/2}$	0
A4W	Width dependence of A4	—	0
AGIDL	GIDL pre-factor	A/V^3	0
AGIDLD	GIDL pre-factor for drain side	A/V^3	0
AGIDLW	Width dependence of GIDL pre-factor for drain side	A/V^3	0
AGIDLW	Width dependence of GIDL pre-factor	A/V^3	0
ALP	CLM pre-factor	—	0.01

Table 2-124. PSP103VA MOSFET with self-heating Device Model Parameters

Parameter	Description	Units	Default
ALP1	CLM enhancement factor above threshold	V	0
ALP1L1	Length dependence of CLM enhancement factor above threshold	V	0
ALP1L2	Second_order length dependence of ALP1	—	0
ALP1LEXP	Exponent for length dependence of ALP1	—	0.5
ALP1W	Width dependence of ALP1	—	0
ALP2	CLM enhancement factor below threshold	V ⁻¹	0
ALP2L1	Length dependence of CLM enhancement factor below threshold	V ⁻¹	0
ALP2L2	Second_order length dependence of ALP2	—	0
ALP2LEXP	Exponent for length dependence of ALP2	—	0.5
ALP2W	Width dependence of ALP2	—	0
ALPL	Length dependence of ALP	—	0.0005
ALPLEXP	Exponent for length dependence of ALP	—	1
ALPNOI	Exponent for length offset for flicker noise	—	2
ALPW	Width dependence of ALP	—	0
AX	Linear/saturation transition factor	—	3
AXL	Length dependence of AX	—	0.4
AXO	Geometry independent linear/saturation transition factor	—	18
BETEDGEW	Width scaling coefficient of edge transistor mobility	—	0
BETN	Channel aspect ratio times zero-field mobility	m ² /(Vs)	0.07
BETNEDGE	Channel aspect ratio times zero-field mobility of edge transistor	m ² /(Vs)	0.0005
BETW1	First higher-order width scaling coefficient of BETN	—	0
BETW2	Second higher-order width scaling coefficient of BETN	—	0
BGIDL	GIDL probability factor at TR	V	41
BGIDLD	GIDL probability factor at TR for drain side	V	41
BGIDLDO	GIDL probability factor at TR for drain side	V	41
BGIDLO	GIDL probability factor at TR	V	41
CBBTBOT	Band-to-band tunneling prefactor of bottom component for source-bulk junction	A/V ³	1e-12
CBBTBOTD	Band-to-band tunneling prefactor of bottom component for drain-bulk junction	A/V ³	1e-12
CBBTGAT	Band-to-band tunneling prefactor of gate-edge component for source-bulk junction	Am/V ³	1e-18

Table 2-124. PSP103VA MOSFET with self-heating Device Model Parameters

Parameter	Description	Units	Default
CBBTGATD	Band-to-band tunneling prefactor of gate-edge component for drain-bulk junction	Am/V ³	1e-18
CBBTSTI	Band-to-band tunneling prefactor of STI-edge component for source-bulk junction	Am/V ³	1e-18
CBBTSTID	Band-to-band tunneling prefactor of STI-edge component for drain-bulk junction	Am/V ³	1e-18
CF	DIBL-parameter	—	0
CFB	Back bias dependence of CF	V ⁻¹	0
CFBEDGE	Bulk voltage dependence parameter of DIBL-parameter of edge transistors	V ⁻¹	0
CFBEDGEO	Bulk voltage dependence parameter of DIBL-parameter of edge transistors	V ⁻¹	0
CFBO	Back-bias dependence of CF	V ⁻¹	0
CFD	Drain voltage dependence of CF	V ⁻¹	0
CFDEEDGE	Drain voltage dependence parameter of DIBL-parameter of edge transistors	V ⁻¹	0
CFDEEDGE0	Drain voltage dependence parameter of DIBL-parameter of edge transistors	V ⁻¹	0
CFDO	Drain voltage dependence of CF	V ⁻¹	0
CFEDGE	DIBL parameter of edge transistors	—	0
CFEDGEL	Length dependence of DIBL-parameter of edge transistors	—	0
CFEDGELEXP	Exponent for length dependence of DIBL-parameter of edge transistors	—	2
CFEDGEW	Width dependence of DIBL-parameter of edge transistors	—	0
CFL	Length dependence of DIBL-parameter	—	0
CFLEXP	Exponent for length dependence of CF	—	2
CFR	Outer fringe capacitance	F	0
CFRD	Outer fringe capacitance for drain side	F	0
CFRDW	Outer fringe capacitance for 1 um wide channel for drain side	F	0
CFRW	Outer fringe capacitance for 1 um wide channel	F	0
CFW	Width dependence of CF	—	0
CGBOV	Oxide capacitance for gate-bulk overlap	F	0
CGBOVL	Oxide capacitance for gate-bulk overlap for 1 um long channel	F	0
CGIDL	Back-bias dependence of GIDL	—	0
CGIDLD	Back-bias dependence of GIDL for drain side	—	0

Table 2-124. PSP103VA MOSFET with self-heating Device Model Parameters

Parameter	Description	Units	Default
CGIDLDO	Back-bias dependence of GIDL for drain side	—	0
CGIDLO	Back-bias dependence of GIDL	—	0
CGOV	Oxide capacitance for gate-drain/source overlap	F	1e-15
CGOVD	Oxide capacitance for gate-drain overlap	F	1e-15
CHIB	Tunnelling barrier height	V	3.1
CHIBO	Tunnelling barrier height	V	3.1
CJORBOT	Zero-bias capacitance per unit-of-area of bottom component for source-bulk junction	F/m ²	0.001
CJORBOTD	Zero-bias capacitance per unit-of-area of bottom component for drain-bulk junction	F/m ²	0.001
CJORGAT	Zero-bias capacitance per unit-of-length of gate-edge component for source-bulk junction	F/m	1e-09
CJORGATD	Zero-bias capacitance per unit-of-length of gate-edge component for drain-bulk junction	F/m	1e-09
CJORSTI	Zero-bias capacitance per unit-of-length of STI-edge component for source-bulk junction	F/m	1e-09
CJORSTID	Zero-bias capacitance per unit-of-length of STI-edge component for drain-bulk junction	F/m	1e-09
COX	Oxide capacitance for intrinsic channel	F	1e-14
CS	Coulomb scattering parameter at TR	—	0
CSL	Length dependence of CS	—	0
CSLEXP	Exponent for length dependence of CS	—	1
CSLW	Area dependence of CS	—	0
CSO	Geometry independent coulomb scattering parameter at TR	—	0
CSRHBOT	Shockley-Read-Hall prefactor of bottom component for source-bulk junction	A/m ³	100
CSRHBOTD	Shockley-Read-Hall prefactor of bottom component for drain-bulk junction	A/m ³	100
CSRHGAT	Shockley-Read-Hall prefactor of gate-edge component for source-bulk junction	A/m ²	0.0001
CSRHGATD	Shockley-Read-Hall prefactor of gate-edge component for drain-bulk junction	A/m ²	0.0001
CSRHSTI	Shockley-Read-Hall prefactor of STI-edge component for source-bulk junction	A/m ²	0.0001
CSRHSTID	Shockley-Read-Hall prefactor of STI-edge component for drain-bulk junction	A/m ²	0.0001
CSW	Width dependence of CS	—	0
CT	Interface states factor	—	0

Table 2-124. PSP103VA MOSFET with self-heating Device Model Parameters

Parameter	Description	Units	Default
CTATBOT	Trap-assisted tunneling prefactor of bottom component for source-bulk junction	A/m ³	100
CTATBOTD	Trap-assisted tunneling prefactor of bottom component for drain-bulk junction	A/m ³	100
CTATGAT	Trap-assisted tunneling prefactor of gate-edge component for source-bulk junction	A/m ²	0.0001
CTATGATD	Trap-assisted tunneling prefactor of gate-edge component for drain-bulk junction	A/m ²	0.0001
CTATSTI	Trap-assisted tunneling prefactor of STI-edge component for source-bulk junction	A/m ²	0.0001
CTATSTID	Trap-assisted tunneling prefactor of STI-edge component for drain-bulk junction	A/m ²	0.0001
CTEDGE	Interface states factor of edge transistors	—	0
CTEDGEL	Length dependence of interface states factor of edge transistors	—	0
CTEDGELEXP	Exponent for length dependence of interface states factor of edge transistors	—	1
CTEDGE0	Geometry-independent interface states factor of edge transistors	—	0
CTH	Thermal capacitance	—	0
CTHLW	Length-correction to width dependence of thermal capacitance	—	0
CTH0	Geometry independent part of thermal capacitance	—	0
CTHW1	Width dependence of thermal capacitance	—	0
CTHW2	Offset in width dependence of thermal capacitance	—	0
CTL	Length dependence of interface states factor	—	0
CTLEXP	Exponent for length dependence of interface states factor	—	1
CTLW	Area dependence of interface states factor	—	0
CT0	Geometry-independent interface states factor	—	0
CTW	Width dependence of interface states factor	—	0
DELVTAC	Offset parameter for PHIB in separate charge calculation	V	0
DELVTACL	Length dependence of DELVTAC	V	0
DELVTACLEXP	Exponent for length dependence of offset of DELVTAC	—	1
DELVTACLW	Area dependence of DELVTAC	V	0
DELVTACO	Geom. independent offset parameter for PHIB in separate charge calculation	V	0
DELVTACW	Width dependence of DELVTAC	V	0

Table 2-124. PSP103VA MOSFET with self-heating Device Model Parameters

Parameter	Description	Units	Default
DLQ	Effective channel length reduction for CV	m	0
DLSIL	Silicide extension over the physical gate length	m	0
DNSUB	Effective doping bias-dependence parameter	V ⁻¹	0
DNSUBO	Effective doping bias-dependence parameter	V ⁻¹	0
DPHIB	Offset parameter for PHIB	V	0
DPHIBEDGE	Offset parameter for PHIB of edge transistors	V	0
DPHIBEDGE L	Length dependence of edge transistor PHIB offset	V	0
DPHIBEDGELEXP	Exponent for length dependence of edge transistor PHIB offset	—	1
DPHIBEDGE L W	Area dependence of edge transistor PHIB offset	V	0
DPHIBEDGE O	Geometry independent of edge transistor PHIB offset	V	0
DPHIBEDGE W	Width dependence of edge transistor PHIB offset	V	0
DPHIB L	Length dependence offset of PHIB	V	0
DPHIBLEXP	Exponent for length dependence of offset of PHIB	—	1
DPHIB L W	Area dependence of offset of PHIB	V	0
DPHIB O	Geometry independent offset of PHIB	V	0
DPHIB W	Width dependence of offset of PHIB	V	0
DTA	Temperature offset w.r.t. ambient temperature	K	0
DVSBNUD	Vsb-range for NUD-effect	V	1
DVSBNUD O	Vsb range for NUD-effect	V	1
DWQ	Effective channel width reduction for CV	m	0
EF	Flicker noise frequency exponent	—	1
EFEDGE	Flicker noise frequency exponent of edge transistors	—	1
EFEDGE O	Flicker noise frequency exponent	—	1
EFO	Flicker noise frequency exponent	—	1
EPSROX	Relative permittivity of gate dielectric	—	3.9
EPSROX O	Relative permittivity of gate dielectric	—	3.9
FACNEFFAC	Pre-factor for effective substrate doping in separate charge calculation	—	1
FACNEFFAC L	Length dependence of FACNEFFAC	—	0
FACNEFFAC L W	Area dependence of FACNEFFAC	—	0
FACNEFFAC O	Geom. independent pre-factor for effective substrate doping in separate charge calculation	—	1
FACNEFFAC W	Width dependence of FACNEFFAC	—	0
FBTTRBOT	Normalization field at the reference temperature for band-to-band tunneling of bottom component for source-bulk junction	Vm ⁻¹	1e+09

Table 2-124. PSP103VA MOSFET with self-heating Device Model Parameters

Parameter	Description	Units	Default
FBBTRBOTD	Normalization field at the reference temperature for band-to-band tunneling of bottom component for drain-bulk junction	Vm^{-1}	1e+09
FBBTRGAT	Normalization field at the reference temperature for band-to-band tunneling of gate-edge component for source-bulk junction	Vm^{-1}	1e+09
FBBTRGATD	Normalization field at the reference temperature for band-to-band tunneling of gate-edge component for drain-bulk junction	Vm^{-1}	1e+09
FBBTRSTI	Normalization field at the reference temperature for band-to-band tunneling of STI-edge component for source-bulk junction	Vm^{-1}	1e+09
FBBTRSTID	Normalization field at the reference temperature for band-to-band tunneling of STI-edge component for drain-bulk junction	Vm^{-1}	1e+09
FBET1	Relative mobility decrease due to first lateral profile	—	0
FBET1W	Width dependence of relative mobility decrease due to first lateral profile	—	0
FBET2	Relative mobility decrease due to second lateral profile	—	0
FBETEDGE	Length dependence of edge transistor mobility	—	0
FETA	Effective field parameter	—	1
FETAO	Effective field parameter	—	1
FJUNQ	Fraction below which source-bulk junction capacitance components are considered negligible	—	0.03
FJUNQD	Fraction below which drain-bulk junction capacitance components are considered negligible	—	0.03
FNT	Thermal noise coefficient	—	1
FNTEDGE	Thermal noise coefficient of edge transistors	—	1
FNTEDGE0	Thermal noise coefficient	—	1
FNTEXC	Excess noise coefficient	—	0
FNTEXCL	Length dependence coefficient of excess noise	—	0
FNTO	Thermal noise coefficient	—	1
FOL1	First length dependence coefficient for short channel body effect	—	0
FOL2	Second length dependence coefficient for short channel body effect	—	0
FREV	Coefficient for reverse breakdown current limitation	—	1000
GC2	Gate current slope factor	—	0.375
GC20	Gate current slope factor	—	0.375

Table 2-124. PSP103VA MOSFET with self-heating Device Model Parameters

Parameter	Description	Units	Default
GC3	Gate current curvature factor	—	0.063
GC30	Gate current curvature factor	—	0.063
GCO	Gate tunnelling energy adjustment	—	0
GCOO	Gate tunnelling energy adjustment	—	0
GFACNUD	Body-factor change due to NUD-effect	—	1
GFACNUDL	Length dependence of GFACNUD	—	0
GFACNUDEXP	Exponent for length dependence of GFACNUD	—	1
GFACNUDLW	Area dependence of GFACNUD	—	0
GFACNUDO	Geom. independent body-factor change due to NUD-effect	—	1
GFACNUDW	Width dependence of GFACNUD	—	0
IDSATRBOT	Saturation current density at the reference temperature of bottom component for source-bulk junction	A/m ²	1e-12
IDSATRBOTD	Saturation current density at the reference temperature of bottom component for drain-bulk junction	A/m ²	1e-12
IDSATRGAT	Saturation current density at the reference temperature of gate-edge component for source-bulk junction	A/m	1e-18
IDSATRGATD	Saturation current density at the reference temperature of gate-edge component for drain-bulk junction	A/m	1e-18
IDSATRSTI	Saturation current density at the reference temperature of STI-edge component for source-bulk junction	A/m	1e-18
IDSATRSTID	Saturation current density at the reference temperature of STI-edge component for drain-bulk junction	A/m	1e-18
IGINV	Gate channel current pre-factor	A	0
IGINVLW	Gate channel current pre-factor for 1 um**2 channel area	A	0
IGOV	Gate overlap current pre-factor	A	0
IGOVD	Gate overlap current pre-factor for drain side	A	0
IGOVDW	Gate overlap current pre-factor for 1 um wide channel for drain side	A	0
IGOVW	Gate overlap current pre-factor for 1 um wide channel	A	0
IMAX	Maximum current up to which forward current behaves exponentially	A	1000
KUO	Mobility degradation/enhancement coefficient	m	0
KUOWEL	Length dependent mobility degradation factor	—	0
KUOWELW	Area dependent mobility degradation factor	—	0
KUOWEO	Geometrical independent mobility degradation factor	—	0
KUOWEW	Width dependent mobility degradation factor	—	0

Table 2-124. PSP103VA MOSFET with self-heating Device Model Parameters

Parameter	Description	Units	Default
KVSAT	Saturation velocity degradation/enhancement coefficient	m	0
KVTHO	Threshold shift parameter	Vm	0
KVTHOWEL	Length dependent threshold shift parameter	—	0
KVTHOWELW	Area dependent threshold shift parameter	—	0
KVTHOWEO	Geometrical independent threshold shift parameter	—	0
KVTHOWEW	Width dependent threshold shift parameter	—	0
LAP	Effective channel length reduction per side	m	0
LEVEL	Model level	—	103
LINTNOI	Length offset for flicker noise	m	0
LKUO	Length dependence of KUO	—	0
LKVTHO	Length dependence of KVTHO	—	0
LLODKUO	Length parameter for UO stress effect	—	0
LLODVTH	Length parameter for VTH-stress effect	—	0
LMAX	Dummy parameter to label binning set	m	1
LMIN	Dummy parameter to label binning set	m	0
LODETAO	Eta0 shift modification factor for stress effect	—	1
LOV	Overlap length for gate/drain and gate/source overlap capacitance	m	0
LOVD	Overlap length for gate/drain overlap capacitance	m	0
LP1	Mobility-related characteristic length of first lateral profile	m	1e-08
LP1W	Width dependence of mobility-related characteristic length of first lateral profile	—	0
LP2	Mobility-related characteristic length of second lateral profile	m	1e-08
LPCK	Char. length of lateral doping profile	m	1e-08
LPCKW	Width dependence of char. length of lateral doping profile	—	0
LPEDGE	Exponent for length dependence of edge transistor mobility	m	1e-08
LVARL	Length dependence of LVAR	—	0
LVARO	Geom. independent difference between actual and programmed gate length	m	0
LVARW	Width dependence of LVAR	—	0
MEFFTATBOT	Effective mass (in units of m0) for trap-assisted tunneling of bottom component for source-bulk junction	—	0.25

Table 2-124. PSP103VA MOSFET with self-heating Device Model Parameters

Parameter	Description	Units	Default
MEFFTATBOTD	Effective mass (in units of m0) for trap-assisted tunneling of bottom component for drain-bulk junction	—	0.25
MEFFTATGAT	Effective mass (in units of m0) for trap-assisted tunneling of gate-edge component for source-bulk junction	—	0.25
MEFFTATGATD	Effective mass (in units of m0) for trap-assisted tunneling of gate-edge component for drain-bulk junction	—	0.25
MEFFTATSTI	Effective mass (in units of m0) for trap-assisted tunneling of STI-edge component for source-bulk junction	—	0.25
MEFFTATSTID	Effective mass (in units of m0) for trap-assisted tunneling of STI-edge component for drain-bulk junction	—	0.25
MUE	Mobility reduction coefficient at TR	m/V	0.5
MUEO	Geometry independent mobility reduction coefficient at TR	m/V	0.5
MUEW	Width dependence of mobility reduction coefficient at TR	—	0
NEFF	Effective substrate doping	m ⁻³	5e+23
NEFFEDGE	Effective substrate doping of edge transistors	m ⁻³	5e+23
NFA	First coefficient of flicker noise	—	8e+22
NFAEDGE	First coefficient of flicker noise of edge transistors	—	8e+22
NFAEDGELW	First coefficient of flicker noise for 1 um**2 channel area	—	8e+22
NFALW	First coefficient of flicker noise for 1 um**2 channel area	—	8e+22
NFB	Second coefficient of flicker noise	—	3e+07
NFBEDGE	Second coefficient of flicker noise of edge transistors	—	3e+07
NFBEDGELW	Second coefficient of flicker noise for 1 um**2 channel area	—	3e+07
NFBLW	Second coefficient of flicker noise for 1 um**2 channel area	—	3e+07
NFC	Third coefficient of flicker noise	V ⁻¹	0
NFCEDGE	Third coefficient of flicker noise of edge transistors	V ⁻¹	0
NFCEDGELW	Third coefficient of flicker noise for 1 um**2 channel area	V ⁻¹	0
NFCLW	Third coefficient of flicker noise for 1 um**2 channel area	V ⁻¹	0
NOV	Effective doping of overlap region	m ⁻³	5e+25

Table 2-124. PSP103VA MOSFET with self-heating Device Model Parameters

Parameter	Description	Units	Default
NOVD	Effective doping of overlap region for drain side	m^{-3}	5e+25
NOVDO	Effective doping of overlap region for drain side	m^{-3}	5e+25
NOVO	Effective doping of overlap region	m^{-3}	5e+25
NP	Gate poly-silicon doping	m^{-3}	1e+26
NPCK	Pocket doping level	m^{-3}	1e+24
NPCKW	Width dependence of pocket doping NPCK due to segregation	—	0
NPL	Length dependence of gate poly-silicon doping	—	0
NPO	Geometry-independent gate poly-silicon doping	m^{-3}	1e+26
NSLP	Effective doping bias-dependence parameter	V	0.05
NSLPO	Effective doping bias-dependence parameter	V	0.05
NSUBEDGEL	Length dependence of edge transistor substrate doping	—	0
NSUBEDGELW	Area dependence of edge transistor substrate doping	—	0
NSUBEDGE0	Geometry independent substrate doping of edge transistors	m^{-3}	5e+23
NSUBEDGEW	Width dependence of edge transistor substrate doping	—	0
NSUBO	Geometry independent substrate doping	m^{-3}	3e+23
NSUBW	Width dependence of background doping NSUBO due to segregation	—	0
PBOT	Grading coefficient of bottom component for source-bulk junction	—	0.5
PBOTD	Grading coefficient of bottom component for drain-bulk junction	—	0.5
PBRBOT	Breakdown onset tuning parameter of bottom component for source-bulk junction	V	4
PBRBOTD	Breakdown onset tuning parameter of bottom component for drain-bulk junction	V	4
PBRGAT	Breakdown onset tuning parameter of gate-edge component for source-bulk junction	V	4
PBRGATD	Breakdown onset tuning parameter of gate-edge component for drain-bulk junction	V	4
PBRSTI	Breakdown onset tuning parameter of STI-edge component for source-bulk junction	V	4
PBRSTID	Breakdown onset tuning parameter of STI-edge component for drain-bulk junction	V	4
PGAT	Grading coefficient of gate-edge component for source-bulk junction	—	0.5
PGATD	Grading coefficient of gate-edge component for drain-bulk junction	—	0.5

Table 2-124. PSP103VA MOSFET with self-heating Device Model Parameters

Parameter	Description	Units	Default
PHIGBOT	Zero-temperature bandgap voltage of bottom component for source-bulk junction	V	1.16
PHIGBOTD	Zero-temperature bandgap voltage of bottom component for drain-bulk junction	V	1.16
PHIGGAT	Zero-temperature bandgap voltage of gate-edge component for source-bulk junction	V	1.16
PHIGGATD	Zero-temperature bandgap voltage of gate-edge component for drain-bulk junction	V	1.16
PHIGSTI	Zero-temperature bandgap voltage of STI-edge component for source-bulk junction	V	1.16
PHIGSTID	Zero-temperature bandgap voltage of STI-edge component for drain-bulk junction	V	1.16
PKUO	Cross-term dependence of KUO	—	0
PKVTHO	Cross-term dependence of KVTHO	—	0
PLA1	Coefficient for the length dependence of A1	—	0
PLA3	Coefficient for the length dependence of A3	—	0
PLA4	Coefficient for the length dependence of A4	$V^{-1/2}$	0
PLAGIDL	Coefficient for the length dependence of AGIDL	A/V^3	0
PLAGIDLD	Coefficient for the length dependence of AGIDL for drain side	A/V^3	0
PLALP	Coefficient for the length dependence of ALP	—	0
PLALP1	Coefficient for the length dependence of ALP1	V	0
PLALP2	Coefficient for the length dependence of ALP2	V^{-1}	0
PLAX	Coefficient for the length dependence of AX	—	0
PLBETN	Coefficient for the length dependence of BETN	$m^2/(Vs)$	0
PLBETNEDGE	Coefficient for the length dependence of BETNEDGE	$m^2/(Vs)$	0
PLCF	Coefficient for the length dependence of CF	—	0
PLCFEDGE	Coefficient for the length dependence of CFEDGE	—	0
PLCFR	Coefficient for the length dependence of CFR	F	0
PLCFRD	Coefficient for the length dependence of CFR for drain side	F	0
PLCGBOV	Coefficient for the length dependence of CGBOV	F	0
PLCGOV	Coefficient for the length dependence of CGOV	F	0
PLCGOVD	Coefficient for the length dependence of CGOV for drain side	F	0
PLCOX	Coefficient for the length dependence of COX	F	0
PLCS	Coefficient for the length dependence of CS	—	0
PLCT	Coefficient for the length dependence of CT	—	0

Table 2-124. PSP103VA MOSFET with self-heating Device Model Parameters

Parameter	Description	Units	Default
PLCTEDGE	Coefficient for the length dependence of CTEDGE	—	0
PLDELVTAC	Coefficient for the length dependence of DELVTAC	V	0
PLDPHIB	Coefficient for the length dependence of DPHIB	V	0
PLDPHIBEDGE	Coefficient for the length dependence of DPHIBEDGE	V	0
PLFACNEFFAC	Coefficient for the length dependence of FACNEFFAC	—	0
PLFNTEXC	Coefficient for the length dependence of FNTEXC	—	0
PLGFACNUD	Coefficient for the length dependence of GFACNUD	—	0
PLIGINV	Coefficient for the length dependence of IGINV	A	0
PLIGOV	Coefficient for the length dependence of IGOV	A	0
PLIGOVD	Coefficient for the length dependence of IGOV for drain side	A	0
PLKUOWE	Coefficient for the length dependence part of KUOWE	—	0
PLKVTHOWE	Coefficient for the length dependence part of KVTHOWE	—	0
PLMUE	Coefficient for the length dependence of MUE	m/V	0
PLNEFF	Coefficient for the length dependence of NEFF	m ⁻³	0
PLNEFFEDGE	Coefficient for the length dependence of NEFFEDGE	m ⁻³	0
PLNFA	Coefficient for the length dependence of NFA	—	0
PLNFAEDGE	Coefficient for the length dependence of NFAEDGE	—	0
PLNFB	Coefficient for the length dependence of NFB	—	0
PLNFBEDGE	Coefficient for the length dependence of NFBEDGE	—	0
PLNFC	Coefficient for the length dependence of NFC	V ⁻¹	0
PLNFCEDGE	Coefficient for the length dependence of NFCEDGE	V ⁻¹	0
PLNOV	Coefficient for the length dependence of NOV	m ⁻³	0
PLNOVD	Coefficient for the length dependence of NOV for drain side	m ⁻³	0
PLNP	Coefficient for the length dependence of NP	m ⁻³	0
PLPSCE	Coefficient for the length dependence of PSCE	—	0
PLPSCEEDGE	Coefficient for the length dependence of PSCEEDGE	—	0
PLRS	Coefficient for the length dependence of RS	Ω	0
PLSTBET	Coefficient for the length dependence of STBET	—	0
PLSTBETEDGE	Coefficient for the length dependence of STBETEDGE	—	0
PLSTTHESAT	Coefficient for the length dependence of STTHESAT	—	0
PLSTVFB	Coefficient for the length dependence of STVFB	V/K	0
PLSTVFBEDGE	Coefficient for the length dependence of STVFBEDGE	V/K	0

Table 2-124. PSP103VA MOSFET with self-heating Device Model Parameters

Parameter	Description	Units	Default
PLTHESAT	Coefficient for the length dependence of THESAT	V^{-1}	0
PLTHESATB	Coefficient for the length dependence of THESATB	V^{-1}	0
PLTHESATG	Coefficient for the length dependence of THESATG	V^{-1}	0
PLVFB	Coefficient for the length dependence of VFB	V	0
PLWA1	Coefficient for the length times width dependence of A1	—	0
PLWA3	Coefficient for the length times width dependence of A3	—	0
PLWA4	Coefficient for the length times width dependence of A4	$V^{-1/2}$	0
PLWAGIDL	Coefficient for the length times width dependence of AGIDL	A/V^3	0
PLWAGIDLD	Coefficient for the length times width dependence of AGIDL for drain side	A/V^3	0
PLWALP	Coefficient for the length times width dependence of ALP	—	0
PLWALP1	Coefficient for the length times width dependence of ALP1	V	0
PLWALP2	Coefficient for the length times width dependence of ALP2	V^{-1}	0
PLWAX	Coefficient for the length times width dependence of AX	—	0
PLWBETN	Coefficient for the length times width dependence of BETN	$m^2/(Vs)$	0
PLWBETNEDGE	Coefficient for the length times width dependence of BETNEDGE	$m^2/(Vs)$	0
PLWCF	Coefficient for the length times width dependence of CF	—	0
PLWCFEDGE	Coefficient for the length times width dependence of CFEDGE	—	0
PLWCFR	Coefficient for the length times width dependence of CFR	F	0
PLWCFRD	Coefficient for the length times width dependence of CFR for drain side	F	0
PLWCGBOV	Coefficient for the length times width dependence of CGBOV	F	0
PLWCGOV	Coefficient for the length times width dependence of CGOV	F	0
PLWCGOVD	Coefficient for the length times width dependence of CGOV for drain side	F	0

Table 2-124. PSP103VA MOSFET with self-heating Device Model Parameters

Parameter	Description	Units	Default
PLWCOX	Coefficient for the length times width dependence of COX	F	0
PLWCS	Coefficient for the length times width dependence of CS	—	0
PLWCT	Coefficient for the length times width dependence of CT	—	0
PLWCTEDGE	Coefficient for the length times width dependence of CTEDGE	—	0
PLWDELVTAC	Coefficient for the length times width dependence of DELVTAC	V	0
PLWDPHIB	Coefficient for the length times width dependence of DPHIB	V	0
PLWDPHIBEDGE	Coefficient for the length times width dependence of DPHIBEDGE	V	0
PLWFACNEFFAC	Coefficient for the length times width dependence of FACNEFFAC	—	0
PLWFNTEXC	Coefficient for the length times width dependence of FNTEXC	—	0
PLWGFACNUD	Coefficient for the length times width dependence of GFACNUD	—	0
PLWIGINV	Coefficient for the length times width dependence of IGINV	A	0
PLWIGOV	Coefficient for the length times width dependence of IGOV	A	0
PLWIGOVD	Coefficient for the length times width dependence of IGOV for drain side	A	0
PLWKUOWE	Coefficient for the length times width dependence part of KUOWE	—	0
PLWKVTHOWE	Coefficient for the length times width dependence part of KVTHOWE	—	0
PLWMUE	Coefficient for the length times width dependence of MUE	m/V	0
PLWNEFF	Coefficient for the length times width dependence of NEFF	m ⁻³	0
PLWNEFFEDGE	Coefficient for the length times width dependence of NEFFEDGE	m ⁻³	0
PLWNFA	Coefficient for the length times width dependence of NFA	—	0
PLWNFAEDGE	Coefficient for the length times width dependence of NFAEDGE	—	0
PLWNFB	Coefficient for the length times width dependence of NFB	—	0

Table 2-124. PSP103VA MOSFET with self-heating Device Model Parameters

Parameter	Description	Units	Default
PLWNFBEDGE	Coefficient for the length times width dependence of NFBEDGE	—	0
PLWNFC	Coefficient for the length times width dependence of NFC	V ⁻¹	0
PLWNFCEDGE	Coefficient for the length times width dependence of NFCEDGE	V ⁻¹	0
PLWNOV	Coefficient for the length times width dependence of NOV	m ⁻³	0
PLWNOVD	Coefficient for the length times width dependence of NOV for drain side	m ⁻³	0
PLWNP	Coefficient for the length times width dependence of NP	m ⁻³	0
PLWPSCE	Coefficient for the length times width dependence of PSCE	—	0
PLWPSCEEDGE	Coefficient for the length times width dependence of PSCEEDGE	—	0
PLWRS	Coefficient for the length times width dependence of RS	Ω	0
PLWSTBET	Coefficient for the length times width dependence of STBET	—	0
PLWSTBETEDGE	Coefficient for the length times width dependence of STBETEDGE	—	0
PLWSTTHESAT	Coefficient for the length times width dependence of STTHESAT	—	0
PLWSTVFB	Coefficient for the length times width dependence of STVFB	V/K	0
PLWSTVFBEDGE	Coefficient for the length times width dependence of STVFBEDGE	V/K	0
PLWTHESAT	Coefficient for the length times width dependence of THESAT	V ⁻¹	0
PLWTHESATB	Coefficient for the length times width dependence of THESATB	V ⁻¹	0
PLWTHESATG	Coefficient for the length times width dependence of THESATG	V ⁻¹	0
PLWVFB	Coefficient for the length times width dependence of VFB	V	0
PLWXCOR	Coefficient for the length times width dependence of XCOR	V ⁻¹	0
PLXCOR	Coefficient for the length dependence of XCOR	V ⁻¹	0
POA1	Coefficient for the geometry independent part of A1	—	1
POA2	Coefficient for the geometry independent part of A2	V	10

Table 2-124. PSP103VA MOSFET with self-heating Device Model Parameters

Parameter	Description	Units	Default
POA3	Coefficient for the geometry independent part of A3	—	1
POA4	Coefficient for the geometry independent part of A4	$V^{-1/2}$	0
POAGIDL	Coefficient for the geometry independent part of AGIDL	A/V^3	0
POAGIDLD	Coefficient for the geometry independent part of AGIDL for drain side	A/V^3	0
POALP	Coefficient for the geometry independent part of ALP	—	0.01
POALP1	Coefficient for the geometry independent part of ALP1	V	0
POALP2	Coefficient for the geometry independent part of ALP2	V^{-1}	0
POAX	Coefficient for the geometry independent part of AX	—	3
POBETN	Coefficient for the geometry independent part of BETN	$m^2/(Vs)$	0.07
POBETNEDGE	Coefficient for the geometry independent part of BETNEDGE	$m^2/(Vs)$	0.0005
POBGIDL	Coefficient for the geometry independent part of BGIDL	V	41
POBGIDLD	Coefficient for the geometry independent part of BGIDL for drain side	V	41
POCF	Coefficient for the geometry independent part of CF	—	0
POCFB	Coefficient for the geometry independent part of CFB	V^{-1}	0
POCFBEDGE	Coefficient for the geometry independent part of CFBEDGE	V^{-1}	0
POCFD	Coefficient for the geometry independent part of CFD	V^{-1}	0
POCFDEDGE	Coefficient for the geometry independent part of CFDEDGE	V^{-1}	0
POCFEDGE	Coefficient for the geometry independent part of CFEDGE	—	0
POCFR	Coefficient for the geometry independent part of CFR	F	0
POCFRD	Coefficient for the geometry independent part of CFR for drain side	F	0
POCGBOV	Coefficient for the geometry independent part of CGBOV	F	0
POCGIDL	Coefficient for the geometry independent part of CGIDL	—	0
POCGIDLD	Coefficient for the geometry independent part of CGIDL for drain side	—	0
POCGOV	Coefficient for the geometry independent part of CGOV	F	1e-15

Table 2-124. PSP103VA MOSFET with self-heating Device Model Parameters

Parameter	Description	Units	Default
POCGOVD	Coefficient for the geometry independent part of CGOV for drain side	F	1e-15
POCHIB	Coefficient for the geometry independent part of CHIB	V	3.1
POCOX	Coefficient for the geometry independent part of COX	F	1e-14
POCS	Coefficient for the geometry independent part of CS	—	0
POCT	Coefficient for the geometry independent part of CT	—	0
POCTEDGE	Coefficient for the geometry independent part of CTEDGE	—	0
PODELVTAC	Coefficient for the geometry independent part of DELVTAC	V	0
PODNSUB	Coefficient for the geometry independent part of DNSUB	V ⁻¹	0
PODPHIB	Coefficient for the geometry independent part of DPHIB	V	0
PODPHIBEDGE	Coefficient for the geometry independent part of DPHIBEDGE	V	0
PODVSBNUD	Coefficient for the geometry independent part of DVSBNUD	V	1
POEF	Coefficient for the flicker noise frequency exponent	—	1
POEFEDGE	Coefficient for the geometry independent part of EFEDGE	—	1
POEPSROX	Coefficient for the geometry independent part of EPSOX	—	3.9
POFACNEFFAC	Coefficient for the geometry independent part of FACNEFFAC	—	1
POFETA	Coefficient for the geometry independent part of FETA	—	1
POFNT	Coefficient for the geometry independent part of FNT	—	1
POFNTEEDGE	Coefficient for the geometry independent part of FNTEEDGE	—	1
POFNTEXC	Coefficient for the geometry independent part of FNTEXC	—	0
POGC2	Coefficient for the geometry independent part of GC2	—	0.375
POGC3	Coefficient for the geometry independent part of GC3	—	0.063
POGCO	Coefficient for the geometry independent part of GCO	—	0
POGFACNUD	Coefficient for the geometry independent part of GFACNUD	—	1
POIGINV	Coefficient for the geometry independent part of IGINV	A	0

Table 2-124. PSP103VA MOSFET with self-heating Device Model Parameters

Parameter	Description	Units	Default
POIGOV	Coefficient for the geometry independent part of IGOV	A	0
POIGOVD	Coefficient for the geometry independent part of IGOV for drain side	A	0
POKUOWE	Coefficient for the geometry independent part of KUOWE	—	0
POKVTHOWE	Coefficient for the geometry independent part of KVTHOWE	—	0
POMUE	Coefficient for the geometry independent part of MUE	m/V	0.5
PONEFF	Coefficient for the geometry independent part of NEFF	m ⁻³	5e+23
PONEFFEDGE	Coefficient for the geometry independent part of NEFFEDGE	m ⁻³	5e+23
PONFA	Coefficient for the geometry independent part of NFA	—	8e+22
PONFAEDGE	Coefficient for the geometry independent part of NFAEDGE	—	8e+22
PONFB	Coefficient for the geometry independent part of NFB	—	3e+07
PONFBEDGE	Coefficient for the geometry independent part of NFBEDGE	—	3e+07
PONFC	Coefficient for the geometry independent part of NFC	V ⁻¹	0
PONFCEDGE	Coefficient for the geometry independent part of NFCEDGE	V ⁻¹	0
PONOV	Coefficient for the geometry independent part of NOV	m ⁻³	5e+25
PONOVD	Coefficient for the geometry independent part of NOV for drain side	m ⁻³	5e+25
PONP	Coefficient for the geometry independent part of NP	m ⁻³	1e+26
PONSLP	Coefficient for the geometry independent part of NSLP	V	0.05
POPSCE	Coefficient for the geometry independent part of PSCE	—	0
POPSCEB	Coefficient for the geometry independent part of PSCEB	V ⁻¹	0
POPSCEBEDGE	Coefficient for the geometry independent part of PSCEBEDGE	V ⁻¹	0
POPSCED	Coefficient for the geometry independent part of PSCED	V ⁻¹	0
POPSCEDEEDGE	Coefficient for the geometry independent part of PSCEDEDGE	V ⁻¹	0
POPSCEEDGE	Coefficient for the geometry independent part of PSCEEDGE	—	0
PORS	Coefficient for the geometry independent part of RS	Ω	30

Table 2-124. PSP103VA MOSFET with self-heating Device Model Parameters

Parameter	Description	Units	Default
PORSB	Coefficient for the geometry independent part of RSB	V ⁻¹	0
PORSG	Coefficient for the geometry independent part of RSG	V ⁻¹	0
POSTA2	Coefficient for the geometry independent part of STA2	V	0
POSTBET	Coefficient for the geometry independent part of STBET	—	1
POSTBETEDGE	Coefficient for the geometry independent part of STBETEDGE	—	1
POSTBGIDL	Coefficient for the geometry independent part of STBGIDL	V/K	0
POSTBGIDLD	Coefficient for the geometry independent part of STBGIDL for drain side	V/K	0
POSTCS	Coefficient for the geometry independent part of STCS	—	0
POSTIG	Coefficient for the geometry independent part of STIG	—	2
POSTMUE	Coefficient for the geometry independent part of STMUE	—	0
POSTRS	Coefficient for the geometry independent part of STRS	—	1
POSTTHEMU	Coefficient for the geometry independent part of STTHEMU	—	1.5
POSTTHESAT	Coefficient for the geometry independent part of STTHESAT	—	1
POSTVFB	Coefficient for the geometry independent part of STVFB	V/K	0.0005
POSTVFBEDGE	Coefficient for the geometry independent part of STVFBEDGE	V/K	0
POSTXCOR	Coefficient for the geometry independent part of STXCOR	—	0
POTHEMU	Coefficient for the geometry independent part of THEMU	—	1.5
POTHEMAT	Coefficient for the geometry independent part of THESAT	V ⁻¹	1
POTHEMATB	Coefficient for the geometry independent part of THESATB	V ⁻¹	0
POTHEMATG	Coefficient for the geometry independent part of THESATG	V ⁻¹	0
POTOX	Coefficient for the geometry independent part of TOX	m	2e-09
POTOXOV	Coefficient for the geometry independent part of TOXOV	m	2e-09
POTOXOVD	Coefficient for the geometry independent part of TOXOV for drain side	m	2e-09
POVFB	Coefficient for the geometry independent part of VFB	V	-1

Table 2-124. PSP103VA MOSFET with self-heating Device Model Parameters

Parameter	Description	Units	Default
POVFBEDGE	Coefficient for the geometry independent part of VFBEDGE	V	-1
POVNSUB	Coefficient for the geometry independent part of VNSUB	V	0
POVP	Coefficient for the geometry independent part of VP	V	0.05
POVSBNUD	Coefficient for the geometry independent part of VSBNUD	V	0
POXCOR	Coefficient for the geometry independent part of XCOR	V ⁻¹	0
PSCE	Subthreshold slope coefficient for short channel transistor	—	0
PSCEB	Bulk voltage dependence parameter of subthreshold slope coefficient for short channel transistor	V ⁻¹	0
PSCEBEDGE	Bulk voltage dependence parameter of subthreshold slope coefficient for short channel edge transistors	V ⁻¹	0
PSCEBEDGE0	Bulk voltage dependence parameter of subthreshold slope coefficient for short channel edge transistors	V ⁻¹	0
PSCEBO	Bulk voltage dependence parameter of subthreshold slope coefficient for short channel transistor	V ⁻¹	0
PSCED	Drain voltage dependence parameter of subthreshold slope coefficient for short channel transistor	V ⁻¹	0
PSCEEDGE	Drain voltage dependence parameter of subthreshold slope coefficient for short channel edge transistors	V ⁻¹	0
PSCEEDGE0	Drain voltage dependence parameter of subthreshold slope coefficient for short channel edge transistors	V ⁻¹	0
PSCEDO	Drain voltage dependence parameter of subthreshold slope coefficient for short channel transistor	V ⁻¹	0
PSCEEDGE	Subthreshold slope coefficient for short channel edge transistors	—	0
PSCEEDGEL	Length dependence of subthreshold slope coefficient for short channel edge transistors	—	0
PSCEEDGELEXP	Exponent for length dependence of subthreshold slope coefficient for short channel edge transistors	—	2
PSCEEDGEW	Exponent for length dependence of subthreshold slope coefficient for short channel edge transistor	—	0
PSCEL	Length dependence of subthreshold slope coefficient for short channel transistor	—	0
PSCELEXP	Exponent for length dependence of subthreshold slope coefficient for short channel transistor	—	2
PSCEW	Exponent for length dependence of subthreshold slope coefficient for short channel transistor	—	0

Table 2-124. PSP103VA MOSFET with self-heating Device Model Parameters

Parameter	Description	Units	Default
PSTI	Grading coefficient of STI-edge component for source-bulk junction	—	0.5
PSTID	Grading coefficient of STI-edge component for drain-bulk junction	—	0.5
PWA1	Coefficient for the width dependence of A1	—	0
PWA3	Coefficient for the width dependence of A3	—	0
PWA4	Coefficient for the width dependence of A4	$V^{-1/2}$	0
PWAGIDL	Coefficient for the width dependence of AGIDL	A/V^3	0
PWAGIDLD	Coefficient for the width dependence of AGIDL for drain side	A/V^3	0
PWALP	Coefficient for the width dependence of ALP	—	0
PWALP1	Coefficient for the width dependence of ALP1	V	0
PWALP2	Coefficient for the width dependence of ALP2	V^{-1}	0
PWAX	Coefficient for the width dependence of AX	—	0
PWBETN	Coefficient for the width dependence of BETN	$m^2/(Vs)$	0
PWBETNEDGE	Coefficient for the width dependence of BETNEDGE	$m^2/(Vs)$	0
PWCF	Coefficient for the width dependence of CF	—	0
PWCFEDGE	Coefficient for the width dependence of CFEDGE	—	0
PWCFR	Coefficient for the width dependence of CFR	F	0
PWCFRD	Coefficient for the width dependence of CFR for drain side	F	0
PWCGBOV	Coefficient for the width dependence of CGBOV	F	0
PWCGOV	Coefficient for the width dependence of CGOV	F	0
PWCGOVD	Coefficient for the width dependence of CGOV for drain side	F	0
PWCOX	Coefficient for the width dependence of COX	F	0
PWCS	Coefficient for the width dependence of CS	—	0
PWCT	Coefficient for the width dependence of CT	—	0
PWCTEDGE	Coefficient for the width dependence of CTEDGE	—	0
PWDELVTAC	Coefficient for the width dependence of DELVTAC	V	0
PWDPHIB	Coefficient for the width dependence of DPHIB	V	0
PWDPHIBEDGE	Coefficient for the width dependence of DPHIBEDGE	V	0
PWFACNEFFAC	Coefficient for the width dependence of FACNEFFAC	—	0
PWFNTEXC	Coefficient for the width dependence of FNTEXC	—	0
PWGFACNUD	Coefficient for the width dependence of GFACNUD	—	0
PWIGINV	Coefficient for the width dependence of IGINV	A	0
PWIGOV	Coefficient for the width dependence of IGOV	A	0

Table 2-124. PSP103VA MOSFET with self-heating Device Model Parameters

Parameter	Description	Units	Default
PWIGOVD	Coefficient for the width dependence of IGOV for drain side	A	0
PWKUOWE	Coefficient for the width dependence part of KUOWE	—	0
PWKVTHOWE	Coefficient for the width dependence part of KVTHOWE	—	0
PWMUE	Coefficient for the width dependence of MUE	m/V	0
PWNEFF	Coefficient for the width dependence of NEFF	m ⁻³	0
PWNEFFEDGE	Coefficient for the width dependence of NEFFEDGE	m ⁻³	0
PWNFA	Coefficient for the width dependence of NFA	—	0
PWNFAEDGE	Coefficient for the width dependence of NFAEDGE	—	0
PWNFB	Coefficient for the width dependence of NFB	—	0
PWNFBEDGE	Coefficient for the width dependence of NFBEDGE	—	0
PWNFC	Coefficient for the width dependence of NFC	V ⁻¹	0
PWNFCEDGE	Coefficient for the width dependence of NFCEDGE	V ⁻¹	0
PWNOV	Coefficient for the width dependence of NOV	m ⁻³	0
PWNOVD	Coefficient for the width dependence of NOV for drain side	m ⁻³	0
PWNP	Coefficient for the width dependence of NP	m ⁻³	0
PWPSCE	Coefficient for the width dependence of PSCE	—	0
PWPSCEEDGE	Coefficient for the width dependence of PSCEEDGE	—	0
PWRS	Coefficient for the width dependence of RS	Ω	0
PWSTBET	Coefficient for the width dependence of STBET	—	0
PWSTBETEDGE	Coefficient for the width dependence of STBETEDGE	—	0
PWSTTHESAT	Coefficient for the width dependence of STTHESAT	—	0
PWSTVFB	Coefficient for the width dependence of STVFB	V/K	0
PWSTVFBEDGE	Coefficient for the width dependence of STVFBEDGE	V/K	0
PWTHESAT	Coefficient for the width dependence of THESAT	V ⁻¹	0
PWTHESATB	Coefficient for the width dependence of THESATB	V ⁻¹	0
PWTHESATG	Coefficient for the width dependence of THESATG	V ⁻¹	0
PWVFB	Coefficient for the width dependence of VFB	V	0
PWXCOR	Coefficient for the width dependence of XCOR	V ⁻¹	0
QMC	Quantum-mechanical correction factor	—	1
RBULK	Bulk resistance between node BP and BI	Ω	0
RBULK0	Bulk resistance between node BP and BI	Ω	0
RDE	External drain resistance	Ω	0
RG	Gate resistance	Ω	0
RGO	Gate resistance	Ω	0

Table 2-124. PSP103VA MOSFET with self-heating Device Model Parameters

Parameter	Description	Units	Default
RINT	Contact resistance between silicide and ploy	$\Omega \text{ m}^2$	0
RJUND	Drain-side bulk resistance between node BI and BD	Ω	0
RJUNDO	Drain-side bulk resistance between node BI and BD	Ω	0
RJUNS	Source-side bulk resistance between node BI and BS	Ω	0
RJUNSO	Source-side bulk resistance between node BI and BS	Ω	0
RS	Series resistance at TR	Ω	30
RSB	Back-bias dependence of series resistance	V^{-1}	0
RSBO	Back-bias dependence of series resistance	V^{-1}	0
RSE	External source resistance	Ω	0
RSG	Gate-bias dependence of series resistance	V^{-1}	0
RSGO	Gate-bias dependence of series resistance	V^{-1}	0
RSH	Sheet resistance of source diffusion	Ω/\square	0
RSHD	Sheet resistance of drain diffusion	Ω/\square	0
RSHG	Gate electrode diffusion sheet resistance	Ω/\square	0
RSW1	Source/drain series resistance for 1 um wide channel at TR	Ω	50
RSW2	Higher-order width scaling of RS	—	0
RTH	Thermal resistance	—	0
RTHLW	Length-correction to width dependence of thermal resistance	—	0
RTHO	Geometry independent part of thermal resistance	—	0
RTHW1	Width dependence of thermal resistance	—	0
RTHW2	Offset in width dependence of thermal resistance	—	0
RVPOLY	Vertical poly resistance	$\Omega \text{ m}^2$	0
RWELL	Well resistance between node BI and B	Ω	0
RWELLO	Well resistance between node BI and B	Ω	0
SAREF	Reference distance between OD-edge and poly from one side	m	1e-06
SBREF	Reference distance between OD-edge and poly from other side	m	1e-06
SCREF	Distance between OD-edge and well edge of a reference device	m	1e-06
STA2	Temperature dependence of A2	V	0
STA20	Temperature dependence of A2	V	0
STBET	Temperature dependence of BETN	—	1
STBETEDGE	Temperature dependence of BETNEDGE	—	1
STBETEDGEL	Length dependence of temperature dependence of BETNEDGE	—	0

Table 2-124. PSP103VA MOSFET with self-heating Device Model Parameters

Parameter	Description	Units	Default
STBETEDGELW	Area dependence of temperature dependence of BETNEDGE	—	0
STBETEDGE0	Geometry independent temperature dependence of BETNEDGE	—	1
STBETEDGEW	Width dependence of temperature dependence of BETNEDGE	—	0
STBETL	Length dependence of temperature dependence of BETN	—	0
STBETLW	Area dependence of temperature dependence of BETN	—	0
STBETO	Geometry independent temperature dependence of BETN	—	1
STBETW	Width dependence of temperature dependence of BETN	—	0
STBGIDL	Temperature dependence of BGIDL	V/K	0
STBGIDLD	Temperature dependence of BGIDL for drain side	V/K	0
STBGIDLDO	Temperature dependence of BGIDL for drain side	V/K	0
STBGIDLO	Temperature dependence of BGIDL	V/K	0
STCS	Temperature dependence of CS	—	0
STCSO	Temperature dependence of CS	—	0
STETA0	Eta0 shift factor related to VTH0 change	m	0
STFBBTBOT	Temperature scaling parameter for band-to-band tunneling of bottom component for source-bulk junction	1/K	-0.001
STFBBTBOTD	Temperature scaling parameter for band-to-band tunneling of bottom component for drain-bulk junction	1/K	-0.001
STFBBTGAT	Temperature scaling parameter for band-to-band tunneling of gate-edge component for source-bulk junction	1/K	-0.001
STFBBTGATD	Temperature scaling parameter for band-to-band tunneling of gate-edge component for drain-bulk junction	1/K	-0.001
STFBBTSTI	Temperature scaling parameter for band-to-band tunneling of STI-edge component for source-bulk junction	1/K	-0.001
STFBBTSTID	Temperature scaling parameter for band-to-band tunneling of STI-edge component for drain-bulk junction	1/K	-0.001
STIG	Temperature dependence of IGINV and IGOV	—	2
STIGO	Temperature dependence of IGINV and IGOV	—	2

Table 2-124. PSP103VA MOSFET with self-heating Device Model Parameters

Parameter	Description	Units	Default
STMUE	Temperature dependence of MUE	—	0
STMUEO	Temperature dependence of MUE	—	0
STRS	Temperature dependence of RS	—	1
STRSO	Temperature dependence of RS	—	1
STRTH	Temperature sensitivity of RTH	—	0
STRTHO	Temperature sensitivity of RTH	—	0
STTHEMU	Temperature dependence of THEMU	—	1.5
STTHEMUO	Temperature dependence of THEMU	—	1.5
STTHESAT	Temperature dependence of THESAT	—	1
STTHESATL	Length dependence of temperature dependence of THESAT	—	0
STTHESATLW	Area dependence of temperature dependence of THESAT	—	0
STTHESATO	Geometry independent temperature dependence of THESAT	—	1
STTHESATW	Width dependence of temperature dependence of THESAT	—	0
STVFB	Temperature dependence of VFB	V/K	0.0005
STVFBEDGE	Temperature dependence of VFBEDGE	V/K	0.0005
STVFBEDGE L	Length dependence of temperature dependence of VFBEDGE	V/K	0
STVFBEDGE L W	Area dependence of temperature dependence of VFBEDGE	V/K	0
STVFBEDGE O	Geometry-independent temperature dependence of VFBEDGE	V/K	0.0005
STVFBEDGE W	Width dependence of temperature dependence of VFBEDGE	V/K	0
STVFB L	Length dependence of temperature dependence of VFB	V/K	0
STVFB L W	Area dependence of temperature dependence of VFB	V/K	0
STVFB O	Geometry-independent temperature dependence of VFB	V/K	0.0005
STVFB W	Width dependence of temperature dependence of VFB	V/K	0
STXCOR	Temperature dependence of XCOR	—	0
STXCOR O	Temperature dependence of XCOR	—	0
SWDELVTAC	Flag for separate capacitance calculation; 0=off, 1=on	—	0
SWEDGE	Flag for drain current of edge transistors; 0=off, 1=on	—	0
SWGEO	Flag for geometrical model, 0=local, 1=global, 2=binning	—	1

Table 2-124. PSP103VA MOSFET with self-heating Device Model Parameters

Parameter	Description	Units	Default
SWGIDL	Flag for GIDL current, 0=turn off IGIDL	—	0
SWGATE	Flag for gate current, 0=turn off IG	—	0
SWIGN	Flag for induced gate noise; 0=off, 1=on	—	1
SWIMPACT	Flag for impact ionization current, 0=turn off II	—	0
SWJUNASYM	Flag for asymmetric junctions; 0=symmetric, 1=asymmetric	—	0
SWJUNCAP	Flag for juncap, 0=turn off juncap	—	0
SWJUNEXP	Flag for JUNCAP-express; 0=full model, 1=express model	—	0
SWNUD	Flag for NUD-effect; 0=off, 1=on, 2=on+CV-correction	—	0
THEMU	Mobility reduction exponent at TR	—	1.5
THEMUO	Mobility reduction exponent at TR	—	1.5
THESAT	Velocity saturation parameter at TR	V ⁻¹	1
THESATB	Back-bias dependence of velocity saturation	V ⁻¹	0
THESATBO	Back-bias dependence of velocity saturation	V ⁻¹	0
THESATG	Gate-bias dependence of velocity saturation	V ⁻¹	0
THESATGO	Gate-bias dependence of velocity saturation	V ⁻¹	0
THESATL	Length dependence of THESAT	V ⁻¹	0.05
THESATLEXP	Exponent for length dependence of THESAT	—	1
THESATLW	Area dependence of velocity saturation parameter	—	0
THESATO	Geometry independent velocity saturation parameter at TR	V ⁻¹	0
THESATW	Width dependence of velocity saturation parameter	—	0
TKUO	Temperature dependence of KUO	—	0
TOX	Gate oxide thickness	m	2e-09
TOXO	Gate oxide thickness	m	2e-09
TOXOV	Overlap oxide thickness	m	2e-09
TOXOVD	Overlap oxide thickness for drain side	m	2e-09
TOXOVDO	Overlap oxide thickness for drain side	m	2e-09
TOXOVO	Overlap oxide thickness	m	2e-09
TR	nominal (reference) temperature	°C	21
TRJ	Reference temperature	°C	21
TYPE	Channel type parameter, +1=NMOS -1=PMOS	—	1
UO	Zero-field mobility at TR	m ² /(Vs)	0.05
VBIRBOT	Built-in voltage at the reference temperature of bottom component for source-bulk junction	V	1

Table 2-124. PSP103VA MOSFET with self-heating Device Model Parameters

Parameter	Description	Units	Default
VBIRBOTD	Built-in voltage at the reference temperature of bottom component for drain-bulk junction	V	1
VBIRGAT	Built-in voltage at the reference temperature of gate-edge component for source-bulk junction	V	1
VBIRGATD	Built-in voltage at the reference temperature of gate-edge component for drain-bulk junction	V	1
VBIRSTI	Built-in voltage at the reference temperature of STI-edge component for source-bulk junction	V	1
VBIRSTID	Built-in voltage at the reference temperature of STI-edge component for drain-bulk junction	V	1
VBRBOT	Breakdown voltage of bottom component for source-bulk junction	V	10
VBRBOTD	Breakdown voltage of bottom component for drain-bulk junction	V	10
VBRGAT	Breakdown voltage of gate-edge component for source-bulk junction	V	10
VBRGATD	Breakdown voltage of gate-edge component for drain-bulk junction	V	10
VBRSTI	Breakdown voltage of STI-edge component for source-bulk junction	V	10
VBRSTID	Breakdown voltage of STI-edge component for drain-bulk junction	V	10
VFB	Flat band voltage at TR	V	-1
VFEDGE	Flat band voltage of edge transistors at TR	V	-1
VFEDGE0	Geometry-independent flat-band voltage of edge transistors at TR	V	-1
VFBL	Length dependence of flat-band voltage	V	0
VFBLW	Area dependence of flat-band voltage	V	0
VFBO	Geometry-independent flat-band voltage at TR	V	-1
VFBW	Width dependence of flat-band voltage	V	0
VJUNREF	Typical maximum source-bulk junction voltage; usually about 2*VSUP	V	2.5
VJUNREFD	Typical maximum drain-bulk junction voltage; usually about 2*VSUP	V	2.5
VNSUB	Effective doping bias-dependence parameter	V	0
VNSUBO	Effective doping bias-dependence parameter	V	0
VP	CLM logarithm dependence factor	V	0.05
VPO	CLM logarithmic dependence parameter	V	0.05
VSBNUD	Lower Vsb value for NUD-effect	V	0
VSBNUDO	Lower Vsb value for NUD-effect	V	0

Table 2-124. PSP103VA MOSFET with self-heating Device Model Parameters

Parameter	Description	Units	Default
WBET	Characteristic width for width scaling of BETN	m	1e-09
WEB	Coefficient for SCB	—	0
WEC	Coefficient for SCC	—	0
WEDGE	Electrical width of edge transistor per side	m	1e-08
WEDGEW	Width dependence of edge WEDGE	—	0
WKUO	Width dependence of KUO	—	0
WKVTHO	Width dependence of KVTHO	—	0
WLOD	Width parameter	m	0
WLODKUO	Width parameter for UO stress effect	—	0
WLODVTH	Width parameter for VTH-stress effect	—	0
WMAX	Dummy parameter to label binning set	m	1
WMIN	Dummy parameter to label binning set	m	0
WOT	Effective channel width reduction per side	m	0
WSEG	Char. length of segregation of background doping NSUBO	m	1e-08
WSEGP	Char. length of segregation of pocket doping NPCK	m	1e-08
WVARL	Length dependence of WVAR	—	0
WVARO	Geom. independent difference between actual and programmed field-oxide opening	m	0
WVARW	Width dependence of WVAR	—	0
XCOR	Non-universality factor	V ⁻¹	0
XCORL	Length dependence of non-universality parameter	—	0
XCORLW	Area dependence of non-universality parameter	—	0
XCORO	Geometry independent non-universality parameter	V ⁻¹	0
XCORW	Width dependence of non-universality parameter	—	0
XJUNGAT	Junction depth of gate-edge component for source-bulk junction	m	1e-07
XJUNGATD	Junction depth of gate-edge component for drain-bulk junction	m	1e-07
XJUNSTI	Junction depth of STI-edge component for source-bulk junction	m	1e-07
XJUNSTID	Junction depth of STI-edge component for drain-bulk junction	m	1e-07

Table 2-125. MOSFET level 1031 Output Variables

Parameter	Description	Units	Default
ctype	Flag for channel type		none
sdint	Flag for source-drain interchange		none
ise	Total source current	A	none
ige	Total gate current	A	none
ide	Total drain current	A	none
ibe	Total bulk current	A	none
ids	Drain current, excl. edge transistor currents, avalanche, tunnel, GISL, GIDL, and junction currents	A	none
idb	Drain to bulk current	A	none
isb	Source to bulk current	A	none
igs	Gate-source tunneling current	A	none
igd	Gate-drain tunneling current	A	none
igb	Gate-bulk tunneling current	A	none
idedge	Drain current of edge transistors	A	none
igcs	Gate-channel tunneling current (source component)	A	none
igcd	Gate-channel tunneling current (drain component)	A	none
iavl	Substrate current due to weak avalanche	A	none
igisl	Gate-induced source leakage current	A	none
igidl	Gate-induced drain leakage current	A	none
ijs	Total source junction current	A	none
ijsbot	Source junction current (bottom component)	A	none
ijsgat	Source junction current (gate-edge component)	A	none
ijssti	Source junction current (STI-edge component)	A	none
ijd	Total drain junction current	A	none
ijdbot	Drain junction current (bottom component)	A	none
ijdgat	Drain junction current (gate-edge component)	A	none
ijdsti	Drain junction current (STI-edge component)	A	none
vds	Drain-source voltage	V	none
vgs	Gate-source voltage	V	none
vsb	Source-bulk voltage	V	none
vto	Zero-bias threshold voltage	V	none
vts	Threshold voltage including back bias effects	V	none
vth	Threshold voltage including back bias and drain bias effects	V	none
vgt	Effective gate drive voltage including back bias and drain bias effects	V	none
vdss	Drain saturation voltage at actual bias	V	none

Table 2-125. MOSFET level 1031 Output Variables

Parameter	Description	Units	Default
vsat	Saturation limit		none
gm	Transconductance	Ω^{-1}	none
gmb	Substrate transconductance	Ω^{-1}	none
gds	Output conductance	Ω^{-1}	none
gjs	Source junction conductance	Ω^{-1}	none
gjd	Drain junction conductance	Ω^{-1}	none
cdd	Drain capacitance	F	none
cdg	Drain-gate capacitance	F	none
cds	Drain-source capacitance	F	none
cdb	Drain-bulk capacitance	F	none
cgd	Gate-drain capacitance	F	none
cgg	Gate capacitance	F	none
cgs	Gate-source capacitance	F	none
cgb	Gate-bulk capacitance	F	none
csd	Source-drain capacitance	F	none
csg	Source-gate capacitance	F	none
css	Source capacitance	F	none
csb	Source-bulk capacitance	F	none
cbd	Bulk-drain capacitance	F	none
cbg	Bulk-gate capacitance	F	none
cbs	Bulk-source capacitance	F	none
cbb	Bulk capacitance	F	none
cgsol	Total gate-source overlap capacitance	F	none
cgdol	Total gate-drain overlap capacitance	F	none
cjs	Total source junction capacitance	F	none
cjsbot	Source junction capacitance (bottom component)	F	none
cjsgat	Source junction capacitance (gate-edge component)	F	none
cjssti	Source junction capacitance (STI-edge component)	F	none
cjd	Total drain junction capacitance	F	none
cjdbot	Drain junction capacitance (bottom component)	F	none
cjdgat	Drain junction capacitance (gate-edge component)	F	none
cjdsti	Drain junction capacitance (STI-edge component)	F	none
weff	Effective channel width for geometrical models	m	none
leff	Effective channel length for geometrical models	m	none
u	Transistor gain		none
rout	Small-signal output resistance	Ohm	none

Table 2-125. MOSFET level 1031 Output Variables

Parameter	Description	Units	Default
vearly	Equivalent Early voltage	V	none
beff	Gain factor	A/V ²	none
fug	Unity gain frequency at actual bias	Hz	none
rg	Gate resistance	Ohm	none
sfl	Flicker noise current spectral density at 1 Hz	A ² /Hz	none
sqrtsff	Input-referred RMS white noise voltage spectral density at 1 kHz	V/sqrt(Hz)	none
sqrtsfw	Input-referred RMS white noise voltage spectral density	V/sqrt(Hz)	none
sid	White noise current spectral density	A ² /Hz	none
sig	Induced gate noise current spectral density at 1 Hz	A ² /Hz	none
cigid	Imaginary part of correlation coefficient between Sig and Sid		none
fknee	Cross-over frequency above which white noise is dominant	Hz	none
sigs	Gate-source current noise spectral density	A ² /Hz	none
sigd	Gate-drain current noise spectral density	A ² /Hz	none
siavl	Impact ionization current noise spectral density	A ² /Hz	none
ssi	Total source junction current noise spectral density	A ² /Hz	none
sdi	Total drain junction current noise spectral density	A ² /Hz	none
sfledge	Flicker noise current spectral density at 1 Hz of edge transistors	A ² /Hz	none
sidedge	White noise current spectral density of edge transistors	A ² /Hz	none
lp_vfb	Local parameter VFB after T-scaling and clipping	V	none
lp_stvfb	Local parameter STVFB after clipping	V/K	none
lp_tox	Local parameter TOX after clipping	m	none
lp_epsrox	Local parameter EPSROX after clipping		none
lp_neff	Local parameter NEFF after clipping	m ⁻³	none
lp_facneffac	Local parameter FACNEFFAC after clipping		none
lp_gfacnud	Local parameter GFACNUD after clipping		none
lp_vsbnud	Local parameter VSBNUD after clipping	V	none
lp_dvsbnud	Local parameter DVSBNUD after clipping	V	none
lp_vnsub	Local parameter VNSUB after clipping	V	none
lp_nslp	Local parameter NSLP after clipping	V	none
lp_dnsud	Local parameter DNSUB after clipping	V ⁻¹	none
lp_dphib	Local parameter DPHIB after clipping	V	none
lp_delvtac	Local parameter DELVTAC after clipping	V	none

Table 2-125. MOSFET level 1031 Output Variables

Parameter	Description	Units	Default
lp_np	Local parameter NP after clipping	m ⁻³	none
lp_ct	Local parameter CT after clipping		none
lp_toxov	Local parameter TOXOV after clipping	m	none
lp_toxovd	Local parameter TOXOVD after clipping	m	none
lp_nov	Local parameter NOV after clipping	m ⁻³	none
lp_novd	Local parameter NOVD after clipping	m ⁻³	none
lp_cf	Local parameter CF after clipping		none
lp_cfd	Local parameter CFD after clipping	V ⁻¹	none
lp_cfb	Local parameter CFB after clipping	V ⁻¹	none
lp_psce	Local parameter PSCE after clipping		none
lp_psceb	Local parameter PSCEB after clipping	V ⁻¹	none
lp_psced	Local parameter PSCED after clipping	V ⁻¹	none
lp_betn	Local parameter BETN after T-scaling and clipping	m ² /(V s)	none
lp_stbet	Local parameter STBET after clipping		none
lp_mue	Local parameter MUE after T-scaling and clipping	m/V	none
lp_stmue	Local parameter STMUE after clipping		none
lp_themu	Local parameter THEMU after T-scaling and clipping		none
lp_stthemu	Local parameter STTHEMU after clipping		none
lp_cs	Local parameter CS after T-scaling and clipping		none
lp_stcs	Local parameter STCS after clipping		none
lp_xcor	Local parameter XCOR after T-scaling and clipping	V ⁻¹	none
lp_stxcor	Local parameter STXCOR after clipping		none
lp_feta	Local parameter FETA after clipping		none
lp_rs	Local parameter RS after T-scaling and clipping	Ohm	none
lp_strs	Local parameter STRS after clipping		none
lp_rsb	Local parameter RSB after clipping	V ⁻¹	none
lp_rsg	Local parameter RSG after clipping	V ⁻¹	none
lp_thesat	Local parameter THESAT after T-scaling and clipping	V ⁻¹	none
lp_stthesat	Local parameter STTHESAT after clipping		none
lp_thesatb	Local parameter THESATB after clipping	V ⁻¹	none
lp_thesatg	Local parameter THESATG after clipping	V ⁻¹	none
lp_ax	Local parameter AX after clipping		none
lp_alp	Local parameter ALP after clipping		none
lp_alp1	Local parameter ALP1 after clipping	V	none
lp_alp2	Local parameter ALP2 after clipping	V ⁻¹	none
lp_vp	Local parameter VP after clipping	V	none

Table 2-125. MOSFET level 1031 Output Variables

Parameter	Description	Units	Default
lp_a1	Local parameter A1 after clipping		none
lp_a2	Local parameter A2 after T-scaling and clipping	V	none
lp_sta2	Local parameter STA2 after clipping		none
lp_a3	Local parameter A3 after clipping		none
lp_a4	Local parameter A4 after clipping	1/sqrt(V)	none
lp_gco	Local parameter GCO after clipping		none
lp_iginv	Local parameter IGINV after T-scaling and clipping	A	none
lp_igov	Local parameter IGOV after T-scaling and clipping	A	none
lp_igovd	Local parameter IGOVD after T-scaling and clipping	A	none
lp_stig	Local parameter STIG after clipping		none
lp_gc2	Local parameter GC2 after clipping		none
lp_gc3	Local parameter GC3 after clipping		none
lp_chib	Local parameter CHIB after clipping	V	none
lp_agidl	Local parameter AGIDL after clipping	A/V^3	none
lp_agidld	Local parameter AGIDLD after clipping	A/V^3	none
lp_bgidl	Local parameter BGIDL after T-scaling and clipping	V	none
lp_bgidld	Local parameter BGIDLD after T-scaling and clipping	V	none
lp_stbgidl	Local parameter STBGIDL after clipping	V/K	none
lp_stbgidld	Local parameter STBGIDLD after clipping	V/K	none
lp_cgidl	Local parameter CGIDL after clipping		none
lp_cgidld	Local parameter CGIDLD after clipping		none
lp_cox	Local parameter COX after clipping	F	none
lp_cgov	Local parameter CGOV after clipping	F	none
lp_cgovd	Local parameter CGOVD after clipping	F	none
lp_cgbov	Local parameter CGBOV after clipping	F	none
lp_cfr	Local parameter CFR after clipping	F	none
lp_cfrd	Local parameter CFRD after clipping	F	none
lp_fnt	Local parameter FNT after clipping		none
lp_fntexc	Local parameter FNTEXC after clipping		none
lp_nfa	Local parameter NFA after clipping	$1/(V\ m^4)$	none
lp_nfb	Local parameter NFB after clipping	$1/(V\ m^4)$	none
lp_nfc	Local parameter NFC after clipping	V^{-1}	none
lp_ef	Local parameter EF after clipping		none
lp_vfbedge	Local parameter VFBEDGE after T-scaling and clipping	V	none
lp_stvfbedge	Local parameter STVFBEDGE after clipping	V/K	none

Table 2-125. MOSFET level 1031 Output Variables

Parameter	Description	Units	Default
lp_dphibedge	Local parameter DPHIBEDGE after clipping	V	none
lp_neffedge	Local parameter NEFFEDGE after clipping	m ⁻³	none
lp_ctedge	Local parameter CTEDGE after clipping		none
lp_betnedge	Local parameter BETNEDGE after T-scaling and clipping	m ² /(Vs)	none
lp_stbetedge	Local parameter STBETEDGE after clipping		none
lp_psceedge	Local parameter PSCEEDGE after clipping		none
lp_pscebedge	Local parameter PSCEBEDGE after clipping	V ⁻¹	none
lp_pscdedge	Local parameter PSCDEEDGE after clipping	V ⁻¹	none
lp_cfedge	Local parameter CFEDGE after clipping	V	none
lp_cfdedge	Local parameter CFDEEDGE after clipping	V ⁻¹	none
lp_cfbedge	Local parameter CFBEDGE after clipping	V ⁻¹	none
lp_fntedge	Local parameter FNTEDGE after clipping		none
lp_nfaedge	Local parameter NFAEDGE after clipping	1/(V m ⁴)	none
lp_nfbedge	Local parameter NFBEDGE after clipping	1/(V m ⁴)	none
lp_nfcedge	Local parameter NFCEDGE after clipping	V ⁻¹	none
lp_efedge	Local parameter EFEDGE after clipping		none
lp_rg	Local parameter RG after clipping	Ohm	none
lp_rse	Local parameter RSE after clipping	Ohm	none
lp_rde	Local parameter RDE after clipping	Ohm	none
lp_rbulk	Local parameter RBULK after clipping	Ohm	none
lp_rwell	Local parameter RWELL after clipping	Ohm	none
lp_rjuns	Local parameter RJUNS after clipping	Ohm	none
lp_rjund	Local parameter RJUND after clipping	Ohm	none
lp_rth	Local parameter RTH after T-scaling and clipping	K/W	none
lp_cth	Local parameter CTH after clipping	J/K	none
lp_strth	Local parameter STRTH after clipping		none
pdiss	Power dissipation	W	none
dtsh	Temperature rise due to self heating	K	none
tk	Device Temperature	K	none
cjosbot	Bottom component of total zero-bias source junction capacitance at device temperature	F	none
cjossti	STI-edge component of total zero-bias source junction capacitance at device temperature	F	none
cjosgat	Gate-edge component of total zero-bias source junction capacitance at device temperature	F	none

Table 2-125. MOSFET level 1031 Output Variables

Parameter	Description	Units	Default
vbisbot	Built-in voltage of source-side bottom junction at device temperature	V	none
vbissti	Built-in voltage of source-side STI-edge junction at device temperature	V	none
vbisgat	Built-in voltage of source-side gate-edge junction at device temperature	V	none
idsatsbot	Total source-side bottom junction saturation current	A	none
idsatssti	Total source-side STI-edge junction saturation current	A	none
idsatsgat	Total source-side gate-edge junction saturation current	A	none
cjosbotd	Bottom component of total zero-bias drain junction capacitance at device temperature	F	none
cjosstid	STI-edge component of total zero-bias drain junction capacitance at device temperature	F	none
cjogasd	Gate-edge component of total zero-bias drain junction capacitance at device temperature	F	none
vbisbotd	Built-in voltage of drain-side bottom junction at device temperature	V	none
vbisstid	Built-in voltage of drain-side STI-edge junction at device temperature	V	none
vbisgaid	Built-in voltage of drain-side gate-edge junction at device temperature	V	none
idsatsbotd	Total drain-side bottom junction saturation current	A	none
idsatsstid	Total drain-side STI-edge junction saturation current	A	none
idsatsgaid	Total drain-side gate-edge junction saturation current	A	none

2.3.20.13. Level 111 MOSFET Tables (BSIM CMG version 111.2.1)

Xyce includes the BSIM CMG Common Multi-gate model version 111. The code in Xyce was generated from the BSIM group's Verilog-A input using the default "ifdef" lines provided, and therefore supports only the subset of BSIM CMG features those defaults enable. Instance and model parameters for the BSIM CMG model are given in tables 2-126 and 2-127. Details of the model are documented in the BSIM-CMG technical report[30], available from the BSIM web site at <http://bsim.berkeley.edu/models/bsimcmg/>.

The BSIM CMG devices support output of the internal variables in tables 2-134, 2-137, and 2-128 on the .PRINT line of a netlist. To access them from a print line, use the syntax N(<instance>:<variable>) where "<instance>" refers to the name of the specific level 107 or 108 M device in your netlist.

Table 2-126. BSIM-CMG FINFET v111.2.1 Device Instance Parameters

Parameter	Description	Units	Default
ADEJ	Drain junction area (BULKMOD = 1 or 2)	m ²	0
ADEO	Drain-to-substrate overlap area through oxide	m ²	0
ASEJ	Source junction area (BULKMOD = 1 or 2)	m ²	0
ASEO	Source-to-substrate overlap area through oxide	m ²	0
CDSP	Constant drain-to-source fringe capacitance (all CGEOMOD)	F	0
CGDP	Constant gate-to-drain fringe capacitance (CGEOMOD = 1)	—	0
CGSP	Constant gate-to-source fringe capacitance (CGEOMOD = 1)	—	0
COVD	Constant gate-to-drain overlap capacitance (CGEOMOD = 1)	—	0
COVS	Constant gate-to-source overlap capacitance (CGEOMOD = 1)	—	0
D	Diameter of the cylinder (GEOMOD = 3)	m	4e-08
DACH1	Total area correction for 1st GAA body	m ²	0
DACH2	Total area correction for 2nd GAA body	m ²	0
DACH3	Total area correction for 3rd GAA body	m ²	0
DACH4	Total area correction for 4th GAA body	m ²	0
DACH5	Total area correction for 5th GAA body	m ²	0
DACH6	Total area correction for 6th GAA body	m ²	0
DELVTRAND	Variability in Vth	V	0
DTEMP	Variability in device temperature	°C	0
DWS1	Total width correction for 1st GAA body	m	0
DWS2	Total width correction for 2nd GAA body	m	0
DWS3	Total width correction for 3rd GAA body	m	0
DWS4	Total width correction for 4th GAA body	m	0

Table 2-126. BSIM-CMG FINFET v111.2.1 Device Instance Parameters

Parameter	Description	Units	Default
DWS5	Total width correction for 5th GAA body	m	0
DWS6	Total width correction for 6th GAA body	m	0
FPITCH	Fin pitch	m	8e-08
HPFF	Fin-height of parasitic finFET	m	5e-09
IDS0MULT	Variability in drain current for miscellaneous reasons	—	1
IGB0MULT	Gate to body current scale factor	—	1
IGC0MULT	Gate to channel current scale factor	—	1
L	Designed gate length	m	3e-08
LRSD	Length of the source/drain	m	0
M	multiplicity factor	—	1
MOBSCMOD	Switch for GAAFET geometry dependent mobility model (0: off; 1: on)	—	0
NF	Number of fingers	—	1
NFIN	Number of fins per finger (real number enables optimization)	—	1
NFINNOM	If non-zero, nominal number of fins per finger	—	0
NGAA	Number of GAA bodies per fin	—	1
NGCON	Number of gate contact (1 or 2 sided)	—	1
NRD	Number of drain diffusion squares	—	0
NRS	Number of source diffusion squares	—	0
PDEJ	Drain-to-substrate PN junction perimeter (BULKMOD = 1 or 2)	m	0
PDEO	Perimeter of drain-to-substrate overlap region through oxide	m	0
PSEJ	Source-to-substrate PN junction perimeter (BULKMOD = 1 or 2)	m	0
PSEO	Perimeter of source-to-substrate overlap region through oxide	m	0
SUBBANDMOD	Switch for GAAFET quantum subband model (0: off; 1: on)	—	0
TFIN	Fin thickness	m	1.5e-08
TGAA	Thickness of individual GAA bodies	m	5e-09
TSUS	Separation between GAA bodies	m	2e-09
U0MULT	Variability in carrier mobility	—	1
WGAA	GAA body width	m	6e-09
XL	L offset for channel length due to mask/etch effect	m	0
XW	W offset for GAA channel width due to mask/etch effect	m	0

Table 2-127. BSIM-CMG FINFET v111.2.1 Device Model Parameters

Parameter	Description	Units	Default
A1	Non-saturation effect parameter for strong inversion Region	—	0
A11	Temperature dependence of A1	—	0
A2	Non-saturation effect parameter for moderate Inversion Region	V ⁻¹	0
A21	Temperature dependence of A2	—	0
ACH_UFCM	Area of the channel for the unified model	m ²	1
ADEJ	Drain junction area (BULKMOD = 1 or 2)	m ²	0
ADEO	Drain-to-substrate overlap area through oxide	m ²	0
ADVTP0	Pre-exponential coefficient for DITS	—	0
ADVTP1	Pre-exponential coefficient for DVTP1	—	0
AEU	Pre-exponential coefficient for EU	—	0
AEUR	Reverse-mode pre-exponential coefficient for EU	—	0
AGIDL	Pre-exponential coefficient for GIDL	—	6.055e-12
AGIDLB	Pre-exponential coefficient for parasitic substrate GIDL	—	6.055e-12
AGISL	Pre-exponential coefficient for GISL	—	0
AGISLB	Pre-exponential coefficient for parasitic substrate GISL	—	0
AIGBACC	Parameter for Igb in accumulation	—	0.0136
AIGBACC1	Parameter for Igb in accumulation	—	0
AIGBINV	Parameter for Igb in inversion	—	0.0111
AIGBINV1	Parameter for Igb in inversion	—	0
AIGC	Parameter for Igc in inversion	—	0.0136
AIGC1	Parameter for Igc in inversion	—	0
AIGD	Parameter for Igd in inversion	—	0
AIGD1	Parameter for Igd in inversion	—	0
AIGEN	Thermal generation current parameter	—	0
AIGS	Parameter for Igs in inversion	—	0.0136
AIGS1	Parameter for Igs in inversion	—	0
ALPHA0	First parameter of Iii	m/V	0
ALPHA01	Temperature dependence of ALPHA0	—	0
ALPHA1	L scaling parameter of Iii	V ⁻¹	0
ALPHA11	Temperature dependence ALPHA1	—	0
ALPHA_UFCM	Mobile charge scaling term taking QM effects into account	—	0.5556
ALPHAIIO	First parameter of Iii for IIMOD = 2	m/V	0

Table 2-127. BSIM-CMG FINFET v111.2.1 Device Model Parameters

Parameter	Description	Units	Default
ALPHAI01	Temperature dependence of ALPHAI0	—	0
ALPHAI1	L scaling parameter of Iii for IIMOD = 2	V ⁻¹	0
ALPHAI11	Temperature dependence of ALPHAI1	—	0
AMEXP	Pre-exponential coefficient for MEXP	—	0
AMEXPR	Pre-exponential coefficient for MEXPR	—	0
APCLM	Pre-exponential coefficient for PCLM	—	0
APCLMR	Reverse-mode pre-exponential coefficient for PCLM	—	0
APSAT	Pre-exponential coefficient for PSAT	—	0
APSATCV	Pre-exponential coefficient for PSATCV	—	0
APTWG	Pre-exponential coefficient for PTWG	—	0
AQMTCCN	Parameter for geometric dependence of Tcen on R/TFIN/HFIN	—	0
ARDSW	Pre-exponential coefficient for RDSW	—	0
ARDW	Pre-exponential coefficient for RDW	—	0
ARSDEND	Extra raised source/drain cross sectional area at the two ends of the finFET	m ²	0
ARSW	Pre-exponential coefficient for RSW	—	0
ASEJ	Source junction area (BULKMOD = 1 or 2)	m ²	0
ASEO	Source-to-substrate overlap area through oxide	m ²	0
ASHEXP	Exponent to tune RTH dependence of NFINTOTAL	—	1
ASILIEND	Extra silicide cross sectional area at the two ends of the FinFET	m ²	0
ASYMMOD	0: Turn off asymmetry model - forward mode parameters used; 1: Turn on asymmetry model	—	0
AT	Saturation velocity temperature coefficient	—	-0.00156
AT2	CRYOMOD != 0 saturation velocity temperature coefficient	—	2e-06
AT2CV	CRYOMOD != 0 saturation velocity temperature coefficient for CV	—	0
ATCV	Saturation velocity temperature coefficient for CV	—	0
ATR	Reverse-mode saturation velocity temperature coefficient	—	0
ATVSRSD	Temperature coefficient for S/D region saturation velocity	—	0
AUA	Pre-exponential coefficient for UA	—	0
AUAR	Reverse-mode pre-exponential coefficient for UA	—	0
AUD	Pre-exponential coefficient for UD	—	0
AUDR	Reverse-mode pre-exponential coefficient for UD	—	0

Table 2-127. BSIM-CMG FINFET v111.2.1 Device Model Parameters

Parameter	Description	Units	Default
AVSAT	Pre-exponential coefficient for VSAT	—	0
AVSAT1	Pre-exponential coefficient for VSAT1	—	0
AVSATCV	Pre-exponential coefficient for VSATCV	—	0
BDVTP0	Exponential coefficient for DITS	—	1e-07
BDVTP1	Exponential coefficient for DVTP1	—	1e-07
BETA0	Vds dependence parameter of Iii	V ⁻¹	0
BETAI0	Vds dependence parameter of Iii	V ⁻¹	0
BETAI1	Vds dependence parameter of Iii	—	0
BETAI2	Vds dependence parameter of Iii	V	0.1
BEU	Exponential coefficient for EU	—	1e-07
BEUR	Reverse-mode exponential coefficient for EU	—	0
BG0SUB	Bandgap of substrate at 300.15K	—	1.12
BGIDL	Exponential coefficient for GIDL	—	3e+08
BGIDLB	Exponential coefficient for parasitic substrate GIDL	—	3e+08
BGISL	Exponential coefficient for GISL	—	0
BGISLB	Exponential coefficient for parasitic substrate GISL	—	0
BIGBACC	Parameter for Igb in accumulation	—	0.00171
BIGBINV	Parameter for Igb in inversion	—	0.000949
BIGC	Parameter for Igc in inversion	—	0.00171
BIGD	Parameter for Igd in inversion	—	0
BIGEN	Thermal generation current parameter	—	0
BIGS	Parameter for Igs in inversion	—	0.00171
BMEXP	Exponential coefficient for MEXP	—	1
BMEXPR	Exponential coefficient for MEXPR	—	0
BPCLM	Exponential coefficient for PCLM	—	1e-07
BPCLMR	Reverse-mode exponential coefficient for PCLM	—	0
BPSAT	Exponential coefficient for PSAT	—	1
BPSATCV	Exponential coefficient for PSATCV	—	0
BPTWG	Exponential coefficient for PTWG	—	1e-07
BQMTCEN	Parameter for geometric dependence of Tcen on R/TFIN/HFIN	—	1.2e-08
BRDSW	exponential coefficient for RDSW	—	1e-07
BRDW	Exponential coefficient for RDW	—	1e-07
BRSW	Exponential coefficient for RSW	—	1e-07
BSHEXP	Exponent to tune RTH dependence of NF	—	1
BUA	Exponential coefficient for UA	—	1e-07

Table 2-127. BSIM-CMG FINFET v111.2.1 Device Model Parameters

Parameter	Description	Units	Default
BUAR	Reverse-mode exponential coefficient for UAR	—	0
BUD	Exponential coefficient for UD	—	5e-08
BU DR	Reverse-mode exponential coefficient for UD	—	0
BULKMOD	0: SOI multi-gate; 1: Bulk multi-gate; 2: for decoupled bulk multi-gate	—	0
BVD	Drain diode breakdown voltage	V	0
BVS	Source diode breakdown voltage	V	10
BVSAT	Exponential coefficient for VSAT	—	1e-07
BVSAT1	Exponential coefficient for VSAT1	—	0
BVSATCV	Exponential coefficient for VSATCV	—	0
CDSC	Coupling capacitance between S/D and channel	—	0.007
CDSCD	Drain-bias sensitivity of CDSC	—	0.007
CDSCDN1	NFIN dependence of CDSCD	—	0
CDSCDN2	NFIN dependence of CDSCD	—	100000
CDSCDR	Reverse-mode drain-bias sensitivity of CDSC	—	0
CDSCDRN1	NFIN dependence of CDSCD	—	0
CDSCDRN2	NFIN dependence of CDSCD	—	0
CDSCN1	NFIN dependence of CDSC	—	0
CDSCN2	NFIN dependence of CDSC	—	100000
CDSP	Constant drain-to-source fringe capacitance (all CGEOMOD)	F	0
CFD	Outer fringe capacitance at drain side	—	0
CFS	Outer fringe capacitance at source side	—	2.5e-11
CGBL	Bias-dependent component of gate-to-substrate overlap capacitance per unit channel length per fin per finger	—	0
CGBN	Gate-to-substrate overlap capacitance per unit channel length per fin per finger	—	0
CGB0	Gate-to-substrate overlap capacitance per unit channel length per finger per NGCON	—	0
CGBW	GAA gate-to-substrate overlap capacitance per unit area per fin per finger	—	0
CGDL	Overlap capacitance between gate and lightly-doped drain region (CGEOMOD = 0, 2, 3)	—	0
CGDO	User-designated non-LDD region drain-gate overlap capacitance per unit channel width	—	0
CGDP	Constant gate-to-drain fringe capacitance (CGEOMOD = 1)	—	0

Table 2-127. BSIM-CMG FINFET v111.2.1 Device Model Parameters

Parameter	Description	Units	Default
CGEO1SW	For CGEOMOD = 1 only, this switch enables the parameters COVS, COVD, CGSP, and CGDP to be in F per fin, per gate-finger, per unit channel width	—	0
CGEOA	Fitting parameter for CGEOMOD = 2 and 3	—	1
CGEOB	Fitting parameter for CGEOMOD = 2 and 3	—	0
CGEOC	Fitting parameter for CGEOMOD = 2 and 3	—	0
CGEOD	Fitting parameter for CGEOMOD = 2 and 3	—	0
CGEOE	Fitting parameter for CGEOMOD = 2 and 3	—	1
CGEOMOD	Geometry-dependent parasitic capacitance model selector	—	0
CGIDL	Parameter for body-effect of GIDL	—	0.5
CGIDLB	Parameter for body-effect of parasitic substrate GIDL	—	0.5
CGISL	Parameter for body-effect of GISL	—	0
CGISLB	Parameter for body-effect of parasitic substrate GISL	—	0
CGSL	Overlap capacitance between gate and lightly-doped source region (CGEOMOD = 0, 2, 3)	—	0
CGSO	User-designated non-LDD region source-gate overlap capacitance per unit channel width	—	0
CGSP	Constant gate-to-source fringe capacitance (CGEOMOD = 1)	—	0
CHARGEWF	Average channel charge weighting factor, 1: source-side, 0: middle, -1: drain-side	—	0
CIGBACC	Parameter for I _{gb} in accumulation	V ⁻¹	0.075
CIGBINV	Parameter for I _{gb} in inversion	V ⁻¹	0.006
CIGC	Parameter for I _{gc} in inversion	V ⁻¹	0.075
CIGD	Parameter for I _{gd} in inversion	V ⁻¹	0
CIGS	Parameter for I _{gs} in inversion	V ⁻¹	0.075
CINS_UFCM	Insulator capacitance for the unified model	—	1
CIT	Parameter for interface traps	—	0
CITR	Parameter for interface traps in reverse mode for asymmetric model	—	0
CJD	Unit area drain-side junction capacitance at zero bias	—	0
CJS	Unit area source-side junction capacitance at zero bias	—	0.0005
CJSWD	Unit length drain-side sidewall junction capacitance at zero bias	—	0
CJSWGD	Unit length drain-side gate sidewall junction capacitance at zero bias	—	0
CJSWGS	Unit length source-side gate sidewall junction capacitance at zero bias	—	0

Table 2-127. BSIM-CMG FINFET v111.2.1 Device Model Parameters

Parameter	Description	Units	Default
CJSWS	Unit length source-side sidewall junction capacitance at zero bias	—	5e-10
CKAPPAB	Bias-dependent gate-to-substrate parasitic capacitance	V	0.6
CKAPPAD	Coefficient of bias-dependent overlap capacitance for the drain side (CGEOMOD = 0, 2, 3)	V	0
CKAPPAS	Coefficient of bias-dependent overlap capacitance for the source side (CGEOMOD = 0, 2, 3)	V	0.6
COVD	Constant gate-to-drain overlap capacitance (CGEOMOD = 1)	—	0
COVS	Constant gate-to-source overlap capacitance (CGEOMOD = 1)	—	0
CRATIO	Ratio of the corner area filled with silicon to the total corner area	—	0.5
CRYOMOD	0: Turn off cryogenic temperature model; 1: Most physical cryogenic temperature models; 2: Cryogenic models converge to BSIM-CMG 111.1.0 temperature models for T > 210 K	—	0
CSDESW	Coefficient for source/drain-to-substrate sidewall capacitance	—	0
CTH0	Thermal capacitance	—	1e-05
CVMOD	0: Consistent I-V and C-V, 1: Decoupled I-V and C-V	—	0
D	Diameter of the cylinder (GEOMOD = 3)	m	4e-08
DACH1	Total area correction for 1st GAA body	m ²	0
DACH2	Total area correction for 2nd GAA body	m ²	0
DACH3	Total area correction for 3rd GAA body	m ²	0
DACH4	Total area correction for 4th GAA body	m ²	0
DACH5	Total area correction for 5th GAA body	m ²	0
DACH6	Total area correction for 6th GAA body	m ²	0
DELTAPRSD	Change in silicon/silicide interface length due to non-rectangular epi	m	0
DELTAVSAT	velocity saturation parameter in the linear region	—	1
DELTAVSATCV	Velocity saturation parameter in the linear region for the capacitance model	—	0
DELTAW	Change of effective width due to shape of fin/cylinder	m	0
DELTAWCV	CV change of effective width due to shape of fin/cylinder	m	0
DELVFBACC	Change in flatband voltage: Vfb_accumulation - Vfb_inversion	V	0
DELVTRAND	Variability in Vth	V	0

Table 2-127. BSIM-CMG FINFET v111.2.1 Device Model Parameters

Parameter	Description	Units	Default
DIM1H	Max dimension for 1st subband (real number enables optimization)	—	3
DIM2H	Max dimension for 2nd subband (real number enables optimization)	—	3
DIM3H	Max dimension for 3rd subband (real number enables optimization)	—	3
DIMENSION1	Dimension for 1st subband (real number enables optimization)	—	2
DIMENSION2	Dimension for 2nd subband (real number enables optimization)	—	2.6
DIMENSION3	Dimension for 3rd subband (real number enables optimization)	—	2.6
DLBIN	Delta L for binning	m	0
DLC	Delta L for C-V model	m	0
DLCACC	Delta L for C-V model in accumulation region (BULKMOD = 1 or 2)	m	0
DLCIGD	Delta L for Igd model	m	0
DLCIGS	Delta L for Igs model	m	0
DMOBLAMP	Minimum clamp on Dmob	m	0.01
DROUT	L dependence of DIBL effect on Rout	—	1.06
DSSP1	Change in SSP1 with WGAA scaling for large WGAA>WSSP0	—	2
DSSP2	Change in SSP2 with WGAA scaling for large WGAA>WSSP0	m	0
DSSP3	Change in SPP3 with WGAA scaling for large WGAA>WSSP0	—	0
DSUB	DIBL exponent coefficient	—	1.06
DTEMP	Variability in device temperature	°C	0
DTLOW	CRYOMOD != 0 smoothing parameter for TLOW	K	1
DTLOW1	CRYOMOD != 0 smoothing parameter for TLOW1	K	0
DVSATCLAMP	Minimum clamp on Dvsat	m	0.01
DVT0	SCE coefficient	—	0
DVT1	SCE exponent coefficient. After binning it should be within (0 : inf)	—	0.6
DVT1SS	Subthreshold swing exponent coefficient. After binning it should be within (0 : inf)	—	0
DVTP0	Coefficient for drain-induced Vth shift (DITS)	—	0
DVTP1	DITS exponent coefficient	—	0
DVTP2	DITS model parameter	—	0

Table 2-127. BSIM-CMG FINFET v111.2.1 Device Model Parameters

Parameter	Description	Units	Default
DVTSHIFT	Vth shift handle	V	0
DVTSHIFTR	Vth shift handle for asymmetric mode	V	0
DWBIN	GAA Delta W for binning	m	0
DWCACC	GAA delta W for C-V model in accumulation region (BULKMOD = 1 or 2)	m	0
DWS1	Total width correction for 1st GAA body	m	0
DWS2	Total width correction for 2nd GAA body	m	0
DWS3	Total width correction for 3rd GAA body	m	0
DWS4	Total width correction for 4th GAA body	m	0
DWS5	Total width correction for 5th GAA body	m	0
DWS6	Total width correction for 6th GAA body	m	0
E2NOM	2nd subband energy for nominal WGAA	—	0.139
E3NOM	3rd subband energy for nominal WGAA	—	2
EASUB	Electron affinity of substrate	—	4.05
EF	Flicker noise frequency exponent	—	1
EGBULK	Bulk band-gap	—	1.1
EGIDL	Band bending parameter for GIDL	V	0.2
EGIDLB	Band bending parameter for parasitic substrate GIDL	V	0.2
EGISL	Band bending parameter for GISL	V	0
EGISLB	Band bending parameter for parasitic substrate GISL	V	0
EIGBINV	Parameter for Igb in inversion	V	1.1
EM	Flicker noise parameter	—	4.1e+07
EMOBT	Temperature coefficient of ETAMOB	—	0
EOT	Equivalent oxide thickness	m	1e-09
EOTACC	Equivalent oxide thickness for accumulation region	m	0
EOTBOX	Equivalent oxide thickness of the buried oxide (SOI FinFET)	m	1.4e-07
EPSROX	Relative dielectric constant of the gate dielectric	—	3.9
EPSRSP	Relative dielectric constant of the spacer	—	3.9
EPSRSUB	Relative dielectric constant of the channel material	—	11.9
ESATII	Saturation channel E-field for Iii	—	1e+07
ETA0	DIBL coefficient	—	0.6
ETA0CV	CVMOD = 1 DIBL coefficient	—	0
ETA0LT	Coupled NFIN and length dependence of ETA0	—	0
ETA0LTCV	Coupled NFIN and length dependence of ETA0CV	—	0
ETA0N1	NFIN dependence of ETA0	—	0

Table 2-127. BSIM-CMG FINFET v111.2.1 Device Model Parameters

Parameter	Description	Units	Default
ETA0N1CV	NFIN dependence of ETA0CV	—	0
ETA0N2	NFIN dependence of ETA0	—	100000
ETA0N2CV	NFIN dependence of ETA0CV	—	0
ETA0R	Reverse-mode DIBL coefficient	—	0
ETAMOB	Effective field parameter	—	2
ETAMOBIR	Ideality parameter	—	0.1
ETAMOBTHIN	Effective field parameter for thin GAA bodies	—	0
ETAMOBTNI	Critical TGAA for non-ideality	m	7.5e-09
EU	Phonon/surface roughness scattering parameter	—	2.5
EU1	CRYOMOD != 0 mobility temperature coefficient for EU	—	-0.001
EUIR	Ideality parameter	—	0.2
EUPTSC	Exponent for TGAA scaling power law	—	3.5
EUR	Reverse-mode phonon/surface roughness scattering parameter	—	0
EUTHIN	Phonon/surface roughness scattering parameter for thin GAA bodies	—	0
EUTNI	Critical TGAA for non-ideality	m	6e-09
FNMOD	0: Old flicker noise model; 1: New flicker noise model	—	0
FPITCH	Fin pitch	m	8e-08
GAVSRD	Parameter for Isat_rd variation with drain voltage	—	0
GEOMOD	0: Double gate; 1: Triple gate; 2: Quadruple gate; 3: Cylindrical gate; 4: Unified fin Shape; 5: GAAFETs	—	0
GIDLMOD	0: Turn off GIDL/GISL current; 1: Turn on GIDL/GISL current; 2: Turn on GIDL/GISL with parasitic substrate component for GEOMOD = 2 or 3 or 5 and BULKMOD != 0	—	0
HEPI	Height of the raised source/drain on top of the fin	m	1e-08
HFIN	Fin height	m	3e-08
HPFF	Fin-height of parasitic finFET	m	5e-09
IDS0MULT	Variability in drain current for miscellaneous reasons	—	1
IGB0MULT	Gate to body current scale factor	—	1
IGBACCCLAMP	Clamping value of the exponent for Igb in accumulation	—	0.001
IGBINVCLAMP	Clamping value of the exponent for Igb in inversion	—	0.001
IGBMOD	0: Turn off Igb; 1: Turn on Igb	—	0
IGC0MULT	Gate to channel current scale factor	—	1
IGCINVCLAMP	Clamping value of the exponent for Igc in inversion	—	0.0005

Table 2-127. BSIM-CMG FINFET v111.2.1 Device Model Parameters

Parameter	Description	Units	Default
IGCLAMP	0: Disable gate current clamps; 1: Enable gate current clamps	—	1
IGCMOD	0: Turn off Igc, Igs and Igd; 1: Turn on Igc, Igs and Igd	—	0
IGT	Gate current temperature dependence	—	2.5
IIMOD	0: Turn off impact ionization current; 1: BSIM4-based model; 2: BSIMSOI-based model	—	0
IIMOD2CLAMP1	Clamp1 of SII1 * Vg term in IIMOD = 2	V	0.1
IIMOD2CLAMP2	Clamp2 of SII0 * Vg term in IIMOD = 2	V	0.1
IIMOD2CLAMP3	Clamp3 of ratio term in IIMOD = 2	—	0.1
IIT	Impact ionization temperature dependence for IIMOD = 1	—	-0.5
IJTHDFWD	Forward drain diode breakdown limiting current	A	0
IJTHDREV	Reverse drain diode breakdown limiting current	A	0
IJTHSFWD	Forward source diode breakdown limiting current	A	0.1
IJTHSREV	Reverse source diode breakdown limiting current	A	0.1
IMIN	Parameter for Vgs clamping for inversion region calculation in accumulation	—	1e-15
JSD	Bottom drain junction reverse saturation current density	—	0
JSS	Bottom source junction reverse saturation current density	—	0.0001
JSWD	Unit length reverse saturation current for sidewall drain junction	—	0
JSWGD	Unit length reverse saturation current for gate-edge sidewall drain junction	—	0
JSWGS	Unit length reverse saturation current for gate-edge sidewall source junction	—	0
JSWS	Unit length reverse saturation current for sidewall source junction	—	0
JTSD	Bottom drain junction trap-assisted saturation current density	—	0
JTSS	Bottom source junction trap-assisted saturation current density	—	0
JTSSWD	Unit length trap-assisted saturation current for sidewall drain junction	—	0
JTSSWGD	Unit length trap-assisted saturation current for gate-edge sidewall drain junction	—	0
JTSSWGS	Unit length trap-assisted saturation current for gate-edge sidewall source junction	—	0

Table 2-127. BSIM-CMG FINFET v111.2.1 Device Model Parameters

Parameter	Description	Units	Default
JTSSWS	Unit length trap-assisted saturation current for sidewall source junction	—	0
JTWEFF	Trap-assisted tunneling current width dependence	m	0
K0	Lateral NUD voltage parameter	V	0
K01	Temperature dependence of lateral NUD voltage parameter	V/K	0
K0SI	Correction factor for strong inversion used in Mnud. After binning it should be within (0 : inf)	—	1
K0SI1	Temperature dependence of K0SI	—	0
K0SISAT	Correction factor for strong inversion used in Mnud	—	0
K0SISAT1	Temperature dependence of K0SISAT	—	0
K1	Body effect coefficient for subthreshold region	—	1e-06
K11	Temperature dependence of K1	—	0
K1RSCE	K1 for reverse short channel effect calculation	—	0
K2	Body effect coefficient for BULKMOD = 2	—	0
K21	Temperature dependence of K2	—	0
K2SAT	Correction factor for K2 in saturation (high Vds)	—	0
K2SAT1	Temperature dependence of K2SAT	—	0
K2SI	Correction factor for strong inversion used in Mob	—	0
K2SI1	Temperature dependence of K2SI	—	0
K2SISAT	Correction factor for strong inversion used in Mob	—	0
K2SISAT1	Temperature dependence of K2SISAT	—	0
KLOW1	CRYOMOD != 0 slope magnitude of effective temperature below TLOW1	—	0
KSATIV	Parameter for long channel Vdsat	—	1
KSATIVR	KSATIV in asymmetric mode	—	0
KSATIVT1	CRYOMOD != 0 temperature coefficient for KSATIV	—	-0.0002
KSATIVT2	CRYOMOD != 0 temperature coefficient for KSATIV	—	-2e-07
KT1	Vth temperature coefficient	V	0
KT11	CRYOMOD != 0 Vth temperature coefficient	V	0.01
KT12	CRYOMOD != 0 Vth temperature coefficient	—	0.1
KT1L	Vth temperature L coefficient	—	0
L	Designed gate length	m	3e-08
LA1	L-term of A1	—	0
LA11	L-term of A11	—	0
LA2	L-term of A2	m/V	0
LA21	L-term of A21	—	0

Table 2-127. BSIM-CMG FINFET v111.2.1 Device Model Parameters

Parameter	Description	Units	Default
LAGIDL	L-term of AGIDL	—	0
LAGIDLB	L-term of AGIDLB	—	0
LAGISL	L-term of AGISL	—	0
LAGISLB	L-term of AGISLB	—	0
LAIGBACC	L-term of AIGBACC	—	0
LAIGBACC1	L-term of AIGBACC1	—	0
LAIGBINV	L-term of AIGBINV	—	0
LAIGBINV1	L-term of AIGBINV1	—	0
LAIGC	L-term of AIGC	—	0
LAIGC1	L-term of AIGC1	—	0
LAIGD	L-term of AIGD	—	0
LAIGD1	L-term of AIGD1	—	0
LAIGEN	L-term of AIGEN	—	0
LAIGS	L-term of AIGS	—	0
LAIGS1	L-term of AIGS1	—	0
LALPHA0	L-term of ALPHA0	—	0
LALPHA1	L-term of ALPHA1	m/V	0
LALPHAII0	L-term of ALPHAII0	—	0
LALPHAII1	L-term of ALPHAII1	m/V	0
LAT	L-term of AT	—	0
LATCV	L-term of ATCV	—	0
LATR	L-term of ATR	—	0
LBETA0	L-term of BETA0	m/V	0
LBETAII0	L-term of BETAII0	m/V	0
LBETAII1	L-term of BETAII1	m	0
LBETAII2	L-term of BETAII2	—	0
LBGIDL	L-term of BGDIDL	V	0
LBGIDLB	L-term of BGDIDLB	V	0
LBGISL	L-term of BGISL	V	0
LBGISLB	L-term of BGISLB	V	0
LBIGBACC	L-term of BIGBACC	—	0
LBIGBINV	L-term of BIGBINV	—	0
LBIGC	L-term of BIGC	—	0
LBIGD	L-term of BIGD	—	0
LBIGEN	L-term of BIGEN	—	0
LBIGS	L-term of BIGS	—	0

Table 2-127. BSIM-CMG FINFET v111.2.1 Device Model Parameters

Parameter	Description	Units	Default
LCDSC	L-term of CDSC	—	0
LCDSCL	L-term of CDSCD	—	0
LCDSCLR	L-term of CDSCDR	—	0
LCFD	L-term of CFD	F	0
LCFS	L-term of CFS	F	0
LCGBL	L-term of CGBL	F	0
LCGDL	L-term of CGDL	F	0
LCGIDL	L-term of CGIDL	—	0
LCGIDLB	L-term of CGIDLB	—	0
LCGISL	L-term of CGISL	—	0
LCGISLB	L-term of CGISLB	—	0
LCGSL	L-term of CGSL	F	0
LCIGBACC	L-term of CIGBACC	m/V	0
LCIGBINV	L-term of CIGBINV	m/V	0
LCIGC	L-term of CIGC	m/V	0
LCIGD	L-term of CIGD	m/V	0
LCIGS	L-term of CIGS	m/V	0
LCIT	L-term of CIT	—	0
LCITR	L-term of CITR	—	0
LCKAPPAB	L-term of CKAPPAB	—	0
LCKAPPAD	L-term of CKAPPAD	—	0
LCKAPPAS	L-term of CKAPPAS	—	0
LCOVD	L-term of COVD	F	0
LCOVS	L-term of COVS	F	0
LDELTAVSAT	L-term of DELTAVSAT	m	0
LDELTAVSATCV	L-term of DELTAVSATCV	m	0
LDIMENSION1	L-term of DIMENSION1	m	0
LDIMENSION2	L-term of DIMENSION2	m	0
LDIMENSION3	L-term of DIMENSION3	m	0
LDLBIN	L-term of DLBIN	m ²	0
LDROUT	L-term of DROUT	m	0
LDSUB	L-term of DSUB	m	0
LDVT0	L-term of DVT0	m	0
LDVT1	L-term of DVT1	m	0
LDVT1SS	L-term of DVT1SS	m	0
LDVTP0	L-term of DVTP0	m	0

Table 2-127. BSIM-CMG FINFET v111.2.1 Device Model Parameters

Parameter	Description	Units	Default
LDVTP1	L-term of DVTP1	m	0
LDVTSHIFT	L-term of DVTSHIFT	—	0
LDVTSHIFTR	L-term of DVTSHIFTR	—	0
LDWBIN	L-term of DWBIN	m ²	0
LE2NOM	L-term of E2NOM	—	0
LE3NOM	L-term of E3NOM	—	0
LEGIDL	L-term of EGIDL	—	0
LEGIDLB	L-term of EGIDLB	—	0
LEGISL	L-term of EGISL	—	0
LEGISLB	L-term of EGISLB	—	0
LEIGBINV	L-term of EIGBINV	—	0
LEMOBT	L-term of EMOBT	m	0
LESATII	L-term of ESATII	V	0
LETA0	L-term of ETA0	m	0
LETA0CV	L-term of ETA0CV	m	0
LETA0R	L-term of ETA0R	m	0
LETAMOB	L-term of ETAMOB	m	0
LEU	L-term of EU	—	0
LEU1	L-term of EU1	m	0
LEUR	L-term of EUR	—	0
LIGT	L-term of IGT	m	0
LII	Channel length dependence parameter of Iii	—	5e-10
LIIT	L-term of IIT	m	0
LINT	Length reduction parameter (dopant diffusion effect)	m	0
LINTIGEN	Lint for thermal generation current	m	0
LINTNOI	L offset for flicker noise calculation	m	0
LK0	L-term of K0	—	0
LK01	L-term of K01	—	0
LK0SI	L-term of K0SI	m	0
LK0SI1	L-term of K0SI1	—	0
LK0SISAT	L-term of K0SISAT	m	0
LK0SISAT1	L-term of K0SISAT1	m	0
LK1	L-term of K1	—	0
LK11	L-term of K11	—	0
LK1RSCE	L-term of K1RSCE	—	0
LK2	L-term of K2	m	0

Table 2-127. BSIM-CMG FINFET v111.2.1 Device Model Parameters

Parameter	Description	Units	Default
LK21	L-term of K21	m	0
LK2SAT	L-term of K2SAT	m	0
LK2SAT1	L-term of K2SAT1	m	0
LK2SI	L-term of K2SI	m	0
LK2SI1	L-term of K2SI1	—	0
LK2SISAT	L-term of K2SISAT	m	0
LK2SISAT1	L-term of K2SISAT1	m	0
LKSATIV	L-term of KSATIV	m	0
LKSATIVR	L-term of KSATIVR	m	0
LKT1	L-term of KT1	—	0
LL	Length reduction parameter (dopant diffusion effect)	—	0
LLC	Length reduction parameter (dopant diffusion effect)	—	0
LLII	L-term of LII	—	0
LLINT	L-term of LINT	m ²	0
LLN	Length reduction parameter (dopant diffusion effect)	—	1
LLPE0	L-term of LPE0	m ²	0
LMAX	Maximum length for which this model should be used	m	100
LMEXP	L-term of MEXP	m	0
LMEXPR	L-term of MEXPR	m	0
LMFQ1NOM	L-term of MFQ1NOM	m	0
LMFQ2NOM	L-term of MFQ2NOM	m	0
LMFQ3NOM	L-term of MFQ3NOM	m	0
LMIN	Minimum length for which this model should be used	m	0
LMPOWER	L-term for MPOWER	m	0
LNBODY	L-term of NBODY	—	0
LNGATE	L-term of NGATE	—	0
LNIGBACC	L-term of NIGBACC	m	0
LNIGBINV	L-term of NIGBINV	m	0
LNOIA2	L-term for NOIA2	—	0
LNTGEN	L-term of NTGEN	m	0
LNTOX	L-term of NTOX	m	0
LPA	Mobility L power coefficient	—	1
LPAR	Reverse-mode mobility L power coefficient	—	0
LPCLM	L-term of PCLM	m	0
LPCLMCV	L-term of PCLMCV	m	0
LPCLMG	L-term of PCLMG	m/V	0

Table 2-127. BSIM-CMG FINFET v111.2.1 Device Model Parameters

Parameter	Description	Units	Default
LPCLMR	L-term of PCLMR	m	0
LPDIBL1	L-term of PDIBL1	m	0
LPDIBL1R	L-term of PDIBL1R	m	0
LPDIBL2	L-term of PDIBL2	m	0
LPDIBL2R	L-term of PDIBL2R	m	0
LPE0	Equivalent length of pocket region at zero bias	m	5e-09
LPGIDL	L-term of PGIDL	m	0
LPGIDLB	L-term of PGIDLB	m	0
LPGISL	L-term of PGISL	m	0
LPGISLB	L-term of PGISLB	m	0
LPHIBE	L-term of PHIBE	—	0
LPHIG	L-term of PHIG	—	0
LPHIN	L-term of PHIN	—	0
LPIGCD	L-term of PIGCD	m	0
LPOXEDGE	L-term of POXEDGE	m	0
LPRT	L-term of PRT	—	0
LPRT1	L-term of PRT1	—	0
LPRWGD	L-term of PRWGD	m/V	0
LPRWGS	L-term of PRWGS	m/V	0
LPSAT	L-term of PSAT	m	0
LPSATCV	L-term of PSATCV	m	0
LPTWG	L-term of PTWG	—	0
LPTWGR	L-term of PTWGR	—	0
LPTWGT	L-term of PTWGT	—	0
LPVAG	L-term of PVAG	m	0
LQMFACOR	L-term of QMFACOR	m	0
LQMTCEVCV	L-term of QMTCEVCV	m	0
LQMTCEVCVA	L-term of QMTCEVCVA	m	0
LQSREF	L-term for QSREF	m	0
LRDSW	L-term of RDSW	—	0
LRDW	L-term of RDW	—	0
LRSD	Length of the source/drain	m	0
LRSW	L-term of RSW	—	0
LSII0	L-term of SII0	m/V	0
LSII1	L-term of SII1	m	0
LSII2	L-term of SII2	—	0

Table 2-127. BSIM-CMG FINFET v111.2.1 Device Model Parameters

Parameter	Description	Units	Default
LSIID	L-term of SIID	—	0
LSP	Thickness of the gate sidewall spacer	m	6e-09
LSPRT	L-term of SPRT	m	0
LSSP1	L-term of SSP1	m	0
LSSP2	L-term of SSP2	m	0
LSSP3	L-term of SSP3	m	0
LTGIDL	L-term of TGIDL	—	0
LTII	L-term of TII	m	0
LTR0	L-term of TR0	—	0
LTSS	L-term of TSS	—	0
LU0	L-term of U0	—	0
LU0CV	L-term of U0CV	—	0
LU0R	L-term of U0R	—	0
LUA	L-term of UA	—	0
LUA1	L-term of UA1	m	0
LUA1CV	L-term of UA1CV	m	0
LUA1R	L-term of UA1R	m	0
LUA2	L-term of UA2	m	0
LUA2CV	L-term of UA2CV	m	0
LUACV	L-term of UACV	—	0
LUAR	L-term of UAR	—	0
LUC	L-term of UC	—	0
LUC1	L-term of UC1	m	0
LUC1CV	L-term of UC1CV	m	0
LUC1R	L-term of UC1R	m	0
LUCCV	L-term of UCCV	—	0
LUCR	L-term of UCR	—	0
LUCS	L-term of UCS	m	0
LUCSTE	L-term of UCSTE	m	0
LUCSTE1	L-term of UCSTE1	m	0
LUD	L-term of UD	—	0
LUD1	L-term of UD1	m	0
LUD1CV	L-term of UD1CV	m	0
LUD1R	L-term of UD1R	m	0
LUD2	L-term of UD2	m	0
LUD2CV	L-term of UD2CV	m	0

Table 2-127. BSIM-CMG FINFET v111.2.1 Device Model Parameters

Parameter	Description	Units	Default
LUDCV	L-term of UDCV	—	0
LUDD	L-term of UDD	m	0
LUDD1	L-term of UDD1	m	0
LUDR	L-term of UDR	—	0
LUDS	L-term of UDS	m	0
LUDS1	L-term of UDS1	m	0
LUP	L-term of UP	—	0
LUPR	L-term of UPR	—	0
LUTE	L-term of UTE	m	0
LUTE1	L-term of UTE1	m	0
LUTE1CV	L-term of UTE1CV	m	0
LUTEKV	L-term of UTEKV	m	0
LUTER	L-term of UTER	m	0
LUTL	L-term of UTL	m	0
LUTLCV	L-term of UTLCV	m	0
LUTLR	L-term of UTLR	m	0
LVSAT	L-term of VSAT	—	0
LVSAT1	L-term of VSAT1	—	0
LVSAT1R	L-term of VSAT1R	—	0
LVSATCV	L-term of VSATCV	—	0
LVSATR	L-term of VSATR	—	0
LWR	L-term of WR	m	0
LXL	L-term of XL	m ²	0
LXRCRG1	L-term of XRCRG1	m	0
LXRCRG2	L-term of XRCRG2	m	0
LXW	L-term of XW	m ²	0
MEXP	Smoothing function factor for Vdsat	—	4
MEXPR	Reverse-mode smoothing function factor for Vdsat	—	0
MFE2	Rate of change in 2nd subband energy with WGAA and TGAA scaling	—	1
MFE3	Rate of change in 3rd subband energy with WGAA and TGAA scaling	—	1
MFQ1	Rate of change in 1st subband charge with WGAA and TGAA scaling	—	1
MFQ1NOM	Scaling factor for 1st subband charge for nominal WGAA	—	11.2

Table 2-127. BSIM-CMG FINFET v111.2.1 Device Model Parameters

Parameter	Description	Units	Default
MFQ2	Rate of change in 2nd subband charge with WGAA and TGAA scaling	—	1
MFQ2NOM	Scaling factor for 2nd subband charge for nominal WGAA	—	8.02
MFQ3	Rate of change in 3rd subband charge with WGAA and TGAA scaling	—	1
MFQ3NOM	Scaling factor for 3rd subband charge for nominal WHSEET	—	6.18
MINR	minr is the value below which the simulator expects elimination of source/drain resistance and it will improve simulation efficiency without significantly altering the results	Ω	0
MJD	Drain bottom junction capacitance grading coefficient	—	0
MJD2	Drain bottom two-step second junction capacitance grading coefficient	—	0
MJS	Source bottom junction capacitance grading coefficient	—	0.5
MJS2	Source bottom two-step second junction capacitance grading coefficient	—	0.125
MJSWD	Drain sidewall junction capacitance grading coefficient	—	0
MJSWD2	Drain sidewall two-step second junction capacitance grading coefficient	—	0
MJSWGD	Drain-side gate sidewall junction capacitance grading coefficient	—	0
MJSWGD2	Drain-side gate sidewall two-step second junction capacitance grading coefficient	—	0
MJSWGS	Source-side gate sidewall junction capacitance grading coefficient	—	0
MJSWGS2	Source-side gate sidewall two-step second junction capacitance grading coefficient	—	0
MJSWS	Source sidewall junction capacitance grading coefficient	—	0.33
MJSWS2	Source sidewall two-step second junction capacitance grading coefficient	—	0.083
MOBSCMOD	Switch for GAAFET geometry dependent mobility model (0: off; 1: on)	—	0
MPOWER	Sub-threshold to strong inversion transition slope Parameter	—	1.2
MVSRSD	Non-linear resistance parameter	—	1
NA1	N-term of A1	—	0

Table 2-127. BSIM-CMG FINFET v111.2.1 Device Model Parameters

Parameter	Description	Units	Default
NA11	N-term of A11	—	0
NA2	N-term of A2	V ⁻¹	0
NA21	N-term of A21	—	0
NAGIDL	N-term of AGIDL	—	0
NAGIDLB	N-term of AGIDLB	—	0
NAGISL	N-term of AGISL	—	0
NAGISLB	N-term of AGISLB	—	0
NAIGBACC	N-term of AIGBACC	—	0
NAIGBACC1	N-term of AIGBACC1	—	0
NAIGBINV	N-term of AIGBINV	—	0
NAIGBINV1	N-term of AIGBINV1	—	0
NAIGC	N-term of AIGC	—	0
NAIGC1	N-term of AIGC1	—	0
NAIGD	N-term of AIGD	—	0
NAIGD1	N-term of AIGD1	—	0
NAIGEN	N-term of AIGEN	—	0
NAIGS	N-term of AIGS	—	0
NAIGS1	N-term of AIGS1	—	0
NALPHA0	N-term of ALPHA0	m/V	0
NALPHA1	N-term of ALPHA1	V ⁻¹	0
NALPHAII0	N-term of ALPHAII0	m/V	0
NALPHAII1	N-term of ALPHAII1	V ⁻¹	0
NAT	N-term of AT	—	0
NATCV	N-term of ATCV	—	0
NATR	N-term of ATR	—	0
NBETA0	N-term of BETA0	V ⁻¹	0
NBETAII0	N-term of BETAII0	V ⁻¹	0
NBETAII1	N-term of BETAII1	—	0
NBETAII2	N-term of BETAII2	V	0
NBGIDL	N-term of BGIDL	—	0
NBGIDLB	N-term of BGIDLB	—	0
NBGISL	N-term of BGISL	—	0
NBGISLB	N-term of BGISLB	—	0
NBIGBACC	N-term of BIGBACC	—	0
NBIGBINV	N-term of BIGBINV	—	0
NBIGC	N-term of BIGC	—	0

Table 2-127. BSIM-CMG FINFET v111.2.1 Device Model Parameters

Parameter	Description	Units	Default
NBIGD	N-term of BIGD	—	0
NBIGEN	N-term of BIGEN	—	0
NBIGS	N-term of BIGS	—	0
NBODY	Channel (body) doping	—	1e+22
NBODYN1	NFIN dependence of channel (body) doping	—	0
NBODYN2	NFIN dependence of channel (body) doping	—	100000
NC0SUB	Conduction band density of states	—	2.86e+25
NCDS	N-term of CDSC	—	0
NCDS	N-term of CDSCD	—	0
NCDS	N-term of CDSCDR	—	0
NCFD	N-term of CFD	—	0
NCFS	N-term of CFS	—	0
NCGBL	N-term of CGBL	—	0
NCGDL	N-term of CGDL	—	0
NCGIDL	N-term of CGIDL	—	0
NCGIDLB	N-term of CGIDLB	—	0
NCGISL	N-term of CGISL	—	0
NCGISLB	N-term of CGISLB	—	0
NCGSL	N-term of CGSL	—	0
NCIGBACC	N-term of CIGBACC	V ⁻¹	0
NCIGBINV	N-term of CIGBINV	V ⁻¹	0
NCIGC	N-term of CIGC	V ⁻¹	0
NCIGD	N-term of CIGD	V ⁻¹	0
NCIGS	N-term of CIGS	V ⁻¹	0
NCIT	N-term of CIT	—	0
NCITR	N-term of CITR	—	0
NCKAPPAB	N-term of CKAPPAB	V	0
NCKAPPAD	N-term of CKAPPAD	V	0
NCKAPPAS	N-term of CKAPPAS	V	0
NCOVD	N-term of COVD	—	0
NCOVS	N-term of COVS	—	0
NDELTAVSAT	N-term of DELTAVSAT	—	0
NDELTAVSATCV	N-term of DELTAVSATCV	—	0
NDIMENSION1	N-term of DIMENSION1	—	0
NDIMENSION2	N-term of DIMENSION2	—	0
NDIMENSION3	N-term of DIMENSION3	—	0

Table 2-127. BSIM-CMG FINFET v111.2.1 Device Model Parameters

Parameter	Description	Units	Default
NDLBIN	N-term of DLBIN	m	0
NDROUT	N-term of DROUT	—	0
NDSUB	N-term of DSUB	—	0
NDVT0	N-term of DVT0	—	0
NDVT1	N-term of DVT1	—	0
NDVT1SS	N-term of DVT1SS	—	0
NDVTP0	N-term of DVTP0	—	0
NDVTP1	N-term of DVTP1	—	0
NDVTSHIFT	N-term of DVTSHIFT	V	0
NDVTSHIFTR	N-term of DVTSHIFTR	V	0
NDWBIN	N-term of DWBIN	m	0
NE2NOM	N-term of E2NOM	—	0
NE3NOM	N-term of E3NOM	—	0
NEGIDL	N-term of EGIDL	V	0
NEGIDLB	N-term of EGIDLB	V	0
NEGISL	N-term of EGISL	V	0
NEGISLB	N-term of EGISLB	V	0
NEIGBINV	N-term of EIGBINV	V	0
NEMOBT	N-term of EMOBT	—	0
NESATII	N-term of ESATII	—	0
NETA0	N-term of ETA0	—	0
NETA0CV	N-term of ETA0CV	—	0
NETA0R	N-term of ETA0R	—	0
NETAMOB	N-term of ETAMOB	—	0
NEU	N-term of EU	—	0
NEU1	N-term of EU1	—	0
NEUR	N-term of EUR	—	0
NFIN	Number of fins per finger (real number enables optimization)	—	1
NFINNOM	If non-zero, nominal number of fins per finger	—	0
NGAA	Number of GAA bodies per fin	—	1
NGATE	Parameter for poly gate doping. For metal gate please set NGATE = 0	—	0
NGCON	Number of gate contact (1 or 2 sided)	—	1
NI0SUB	Intrinsic carrier constant at 300.15K	—	1.1e+16
NIGBACC	Parameter for Igb in accumulation	—	1

Table 2-127. BSIM-CMG FINFET v111.2.1 Device Model Parameters

Parameter	Description	Units	Default
NIGBINV	Parameter for Igb in inversion	—	3
NIGT	N-term of IGT	—	0
NIIT	N-term of IIT	—	0
NJD	Drain junction emission coefficient	—	0
NJS	Source junction emission coefficient	—	1
NJTS	Non-ideality factor for JTSS	—	20
NJTSD	Non-ideality factor for JTSD	—	0
NJTSSW	Non-ideality factor for JTSSWS	—	20
NJTSSWD	Non-ideality factor for JTSSWD	—	0
NJTSSWG	Non-ideality factor for JTSSWGS	—	20
NJTSSWGD	Non-ideality factor for JTSSWGD	—	0
NK0	N-term of K0	V	0
NK01	N-term of K01	V/K	0
NK0SI	N-term of K0SI	—	0
NK0SI1	N-term of K0SI1	—	0
NK0SISAT	N-term of K0SISAT	—	0
NK0SISAT1	N-term of K0SISAT1	—	0
NK1	N-term of K1	—	0
NK11	N-term of K11	—	0
NK1RSCE	N-term of K1RSCE	—	0
NK2	N-term of K2	—	0
NK21	N-term of K21	—	0
NK2SAT	N-term of K2SAT	—	0
NK2SAT1	N-term of K2SAT1	—	0
NK2SI	N-term of K2SI	—	0
NK2SI1	N-term of K2SI1	—	0
NK2SISAT	N-term of K2SISAT	—	0
NK2SISAT1	N-term of K2SISAT1	—	0
NKSATIV	N-term of KSATIV	—	0
NKSATIVR	N-term of KSATIVR	—	0
NKT1	N-term of KT1	V	0
NLII	N-term of LII	—	0
NLINT	N-term of LINT	m	0
NLPE0	N-term of LPE0	m	0
NMEXP	N-term of MEXP	—	0
NMEXPR	N-term of MEXPR	—	0

Table 2-127. BSIM-CMG FINFET v111.2.1 Device Model Parameters

Parameter	Description	Units	Default
NMFQ1NOM	N-term of MFQ1NOM	—	0
NMFQ2NOM	N-term of MFQ2NOM	—	0
NMFQ3NOM	N-term of MFQ3NOM	—	0
NMPOWER	N-term for MPOWER	—	0
NNBODY	N-term of NBODY	—	0
NNGATE	N-term of NGATE	—	0
NNIGBACC	N-term of NIGBACC	—	0
NNIGBINV	N-term of NIGBINV	—	0
NNOIA2	N-term for NOIA2	—	0
NNTGEN	N-term of NTGEN	—	0
NNTOX	N-term of NTOX	—	0
NOIA	Flicker noise parameter	—	6.25e+39
NOIA2	Flicker noise parameter for sub-threshold region	—	0
NOIB	Flicker noise parameter	—	3.125e+24
NOIC	Flicker noise parameter	—	8.75e+07
NPCLM	N-term of PCLM	—	0
NPCLMCV	N-term of PCLMCV	—	0
NPCLMG	N-term of PCLMG	V ⁻¹	0
NPCLMR	N-term of PCLMR	—	0
NPDIBL1	N-term of PDIBL1	—	0
NPDIBL1R	N-term of PDIBL1R	—	0
NPDIBL2	N-term of PDIBL2	—	0
NPDIBL2R	N-term of PDIBL2R	—	0
NPGIDL	N-term of PGIDL	—	0
NPGIDLB	N-term of PGIDLB	—	0
NPGISL	N-term of PGISL	—	0
NPGISLB	N-term of PGISLB	—	0
NPHIBE	N-term of PHIBE	V	0
NPHIG	N-term of PHIG	—	0
NPHIN	N-term of PHIN	V	0
NPIGCD	N-term of PIGCD	—	0
NPOXEDGE	N-term of POXEDGE	—	0
NPRT	N-term of PRT	—	0
NPRT1	N-term of PRT1	—	0
NPRWGD	N-term of PRWGD	V ⁻¹	0
NPRWGS	N-term of PRWGS	V ⁻¹	0

Table 2-127. BSIM-CMG FINFET v111.2.1 Device Model Parameters

Parameter	Description	Units	Default
NPSAT	N-term of PSAT	—	0
NPSATCV	N-term of PSATCV	—	0
NPTWG	N-term of PTWG	—	0
NPTWGR	N-term of PTWGR	—	0
NPTWGT	N-term of PTWGT	—	0
NPVAG	N-term of PVAG	—	0
NQMFACOR	N-term of QMFACOR	—	0
NQMTCENCV	N-term of QMTCENCV	—	0
NQMTCENCVA	N-term of QMTCENCVA	—	0
NQSMOD	0: Turn off NQS model; 1: NQS gate resistance (with gi node); 2: NQS charge deficit model from BSIM4 (with q node)	—	0
NQSREF	N-term for QSREF	—	0
NRD	Number of drain diffusion squares	—	0
NRDSW	N-term of RDSW	—	0
NRDW	N-term of RDW	—	0
NRS	Number of source diffusion squares	—	0
NRSW	N-term of RSW	—	0
NSD	Source/drain active doping concentration	—	2e+26
NSII0	N-term of SII0	V ⁻¹	0
NSII1	N-term of SII1	—	0
NSII2	N-term of SII2	V	0
NSIID	N-term of SIID	V	0
NSPRT	N-term of SPRT	—	0
NSSP1	N-term of SSP1	—	0
NSSP2	N-term of SSP2	—	0
NSSP3	N-term of SSP3	—	0
NTGEN	Thermal generation current parameter	—	1
NTGIDL	N-term of TGIDL	—	0
NTII	N-term of TII	—	0
NTNOI	Thermal noise parameter	—	1
NTOX	Exponent for Tox ratio	—	1
NTR0	N-term of TR0	K	0
NTSS	N-term of TSS	—	0
NU0	N-term of U0	—	0
NU0CV	N-term of U0CV	—	0

Table 2-127. BSIM-CMG FINFET v111.2.1 Device Model Parameters

Parameter	Description	Units	Default
NUØR	N-term of UØR	—	0
NUA	N-term of UA	—	0
NUA1	N-term of UA1	—	0
NUA1CV	N-term of UA1CV	—	0
NUA1R	N-term of UA1R	—	0
NUA2	N-term of UA2	—	0
NUA2CV	N-term of UA2CV	—	0
NUACV	N-term of UACV	—	0
NUAR	N-term of UAR	—	0
NUC	N-term of UC	—	0
NUC1	N-term of UC1	—	0
NUC1CV	N-term of UC1CV	—	0
NUC1R	N-term of UC1R	—	0
NUCCV	N-term of UCCV	—	0
NUCR	N-term of UCR	—	0
NUCS	N-term of UCS	—	0
NUCSTE	N-term of UCSTE	—	0
NUCSTE1	N-term of UCSTE1	—	0
NUD	N-term of UD	—	0
NUD1	N-term of UD1	—	0
NUD1CV	N-term of UD1CV	—	0
NUD1R	N-term of UD1R	—	0
NUD2	N-term of UD2	—	0
NUD2CV	N-term of UD2CV	—	0
NUDCV	N-term of UDCV	—	0
NUDD	N-term of UDD	—	0
NUDD1	N-term of UDD1	—	0
NUDR	N-term of UDR	—	0
NUDS	N-term of UDS	—	0
NUDS1	N-term of UDS1	—	0
NUP	N-term of UP	—	0
NUPR	N-term of UPR	—	0
NUTE	N-term of UTE	—	0
NUTE1	N-term of UTE1	—	0
NUTE1CV	N-term of UTE1CV	—	0
NUTECV	N-term of UTECV	—	0

Table 2-127. BSIM-CMG FINFET v111.2.1 Device Model Parameters

Parameter	Description	Units	Default
NUTER	N-term of UTER	—	0
NUTL	N-term of UTL	—	0
NUTLCV	N-term of UTLCV	—	0
NUTLR	N-term of UTLR	—	0
NVSAT	N-term of VSAT	—	0
NVSAT1	N-term of VSAT1	—	0
NVSAT1R	N-term of VSAT1R	—	0
NVSATCV	N-term of VSATCV	—	0
NVSATR	N-term of VSATR	—	0
NVSRD	Charge density in the drain region	—	5e+16
NVSRS	Charge density in the source region	—	0
NVTM	If non-zero, subthreshold swing factor multiplied by V _{tm} .	V	0
NWR	N-term of WR	—	0
NXL	N-term of XL	m	0
NXRCRG1	N-term of XRCRG1	—	0
NXRCRG2	N-term of XRCRG2	—	0
NXW	N-term of XW	m	0
P2A1	WL-term of A1	—	0
P2A11	WL-term of A11	—	0
P2A2	WL-term of A2	—	0
P2A21	WL-term of A21	—	0
P2AGIDL	WL-term of AGIDL	—	0
P2AGIDLB	WL-term of AGIDLB	—	0
P2AGISL	WL-term of AGISL	—	0
P2AGISLB	WL-term of AGISLB	—	0
P2AIGBACC	WL-term of AIGBACC	—	0
P2AIGBACC1	WL-term of AIGBACC1	—	0
P2AIGBINV	WL-term of AIGBINV	—	0
P2AIGBINV1	WL-term of AIGBINV1	—	0
P2AIGC	WL-term of AIGC	—	0
P2AIGC1	WL-term of AIGC1	—	0
P2AIGD	WL-term of AIGD	—	0
P2AIGD1	WL-term of AIGD1	—	0
P2AIGEN	WL-term of AIGEN	—	0
P2AIGS	WL-term of AIGS	—	0

Table 2-127. BSIM-CMG FINFET v111.2.1 Device Model Parameters

Parameter	Description	Units	Default
P2AIGS1	WL-term of AIGS1	—	0
P2ALPHA0	WL-term of ALPHA0	—	0
P2ALPHA1	WL-term of ALPHA1	—	0
P2ALPHAIIO	WL-term of ALPHAIIO	—	0
P2ALPHAIIO1	WL-term of ALPHAIIO1	—	0
P2AT	WL-term of AT	—	0
P2ATCV	WL-term of ATCV	—	0
P2ATR	WL-term of ATR	—	0
P2BETA0	WL-term of BETA0	—	0
P2BETAIIO	WL-term of BETAIIO	—	0
P2BETAIIO1	WL-term of BETAIIO1	m ²	0
P2BETAIIO2	WL-term of BETAIIO2	—	0
P2BGIDL	WL-term of BGIDL	—	0
P2BGIDLB	WL-term of BGIDLB	—	0
P2BGISL	WL-term of BGISL	—	0
P2BGISLB	WL-term of BGISLB	—	0
P2BIGBACC	WL-term of BIGBACC	—	0
P2BIGBINV	WL-term of BIGBINV	—	0
P2BIGC	WL-term of BIGC	—	0
P2BIGD	WL-term of BIGD	—	0
P2BIGEN	WL-term of BIGEN	—	0
P2BIGS	WL-term of BIGS	—	0
P2CDSC	WL-term of CDSC	F	0
P2CDSCD	WL-term of CDSCD	F	0
P2CDSCDR	WL-term of CDSCDR	F	0
P2CFD	WL-term of CFD	—	0
P2CFS	WL-term of CFS	—	0
P2CGBL	WL-term of CGBL	—	0
P2CGDL	WL-term of CGDL	—	0
P2CGIDL	WL-term of CGIDL	—	0
P2CGIDLB	WL-term of CGIDLB	—	0
P2CGISL	WL-term of CGISL	—	0
P2CGISLB	WL-term of CGISLB	—	0
P2CGSL	WL-term of CGSL	—	0
P2CIGBACC	WL-term of CIGBACC	—	0
P2CIGBINV	WL-term of CIGBINV	—	0

Table 2-127. BSIM-CMG FINFET v111.2.1 Device Model Parameters

Parameter	Description	Units	Default
P2CIGC	WL-term of CIGC	—	0
P2CIGD	WL-term of CIGD	—	0
P2CIGS	WL-term of CIGS	—	0
P2CIT	WL-term of CIT	F	0
P2CITR	WL-term of CITR	F	0
P2CKAPPAB	WL-term of CKAPPAB	—	0
P2CKAPPAD	WL-term of CKAPPAD	—	0
P2CKAPPAS	WL-term of CKAPPAS	—	0
P2COVD	WL-term of COVD	—	0
P2COVS	WL-term of COVS	—	0
P2DELTAVSAT	WL-term of DELTAVSAT	m ²	0
P2DELTAVSATCV	WL-term of DELTAVSATCV	m ²	0
P2DIMENSION1	WL-term of DIMENSION1	m ²	0
P2DIMENSION2	WL-term of DIMENSION2	m ²	0
P2DIMENSION3	WL-term of DIMENSION3	m ²	0
P2DROUT	WL-term of DROUT	m ²	0
P2DSUB	WL-term of DSUB	m ²	0
P2DVT0	WL-term of DVT0	m ²	0
P2DVT1	WL-term of DVT1	m ²	0
P2DVT1SS	WL-term of DVT1SS	m ²	0
P2DVTP0	WL-term of DVTP0	m ²	0
P2DVTP1	WL-term of DVTP1	m ²	0
P2DVTSHIFT	WL-term of DVTSHIFT	—	0
P2DVTSHIFTR	WL-term of DVTSHIFTR	—	0
P2DWBIN	WL-term of DWBIN	—	0
P2E2NOM	WL-term of E2NOM	—	0
P2E3NOM	WL-term of E3NOM	—	0
P2EGIDL	WL-term of EGIDL	—	0
P2EGIDLB	WL-term of EGIDLB	—	0
P2EGISL	WL-term of EGISL	—	0
P2EGISLB	WL-term of EGISLB	—	0
P2EIGBINV	WL-term of EIGBINV	—	0
P2EMOBT	WL-term of EMOBT	m ²	0
P2ESATII	WL-term of ESATII	—	0
P2ETA0	WL-term of ETA0	m ²	0
P2ETA0CV	WL-term of ETA0CV	m ²	0

Table 2-127. BSIM-CMG FINFET v111.2.1 Device Model Parameters

Parameter	Description	Units	Default
P2ETA0R	WL-term of ETA0R	m ²	0
P2ETAMOB	WL-term of ETAMOB	m ²	0
P2EU	WL-term of EU	—	0
P2EU1	WL-term of EU1	m ²	0
P2EUR	WL-term of EUR	—	0
P2IGT	WL-term of IGT	m ²	0
P2IIT	WL-term of IIT	m ²	0
P2K0	WL-term of K0	—	0
P2K01	WL-term of K01	—	0
P2K0SI	WL-term of K0SI	m ²	0
P2K0SI1	WL-term of K0SI1	—	0
P2K0SISAT	WL-term of K0SISAT	m ²	0
P2K0SISAT1	WL-term of K0SISAT1	m ²	0
P2K1	WL-term of K1	—	0
P2K11	WL-term of K11	—	0
P2K1RSCE	WL-term of K1RSCE	—	0
P2K2	WL-term of K2	m ²	0
P2K21	WL-term of K21	m ²	0
P2K2SAT	WL-term of K2SAT	m ²	0
P2K2SAT1	WL-term of K2SAT1	m ²	0
P2K2SI	WL-term of K2SI	m ²	0
P2K2SI1	WL-term of K2SI1	—	0
P2K2SISAT	WL-term of K2SISAT	m ²	0
P2K2SISAT1	WL-term of K2SISAT1	m ²	0
P2KSATIV	WL-term of KSATIV	m ²	0
P2KSATIVR	WL-term of KSATIVR	m ²	0
P2KT1	WL-term of KT1	—	0
P2LII	WL-term of LII	—	0
P2LPE0	WL-term of LPE0	—	0
P2MEXP	WL-term of MEXP	m ²	0
P2MEXPR	WL-term of MEXPR	m ²	0
P2MFQ1NOM	WL-term of MFQ1NOM	m ²	0
P2MFQ2NOM	WL-term of MFQ2NOM	m ²	0
P2MFQ3NOM	WL-term of MFQ3NOM	m ²	0
P2MPOWER	WL-term for MPOWER	m ²	0
P2NGATE	WL-term of NGATE	—	0

Table 2-127. BSIM-CMG FINFET v111.2.1 Device Model Parameters

Parameter	Description	Units	Default
P2NIGBACC	WL-term of NIGBACC	m ²	0
P2NIGBINV	WL-term of NIGBINV	m ²	0
P2NOIA2	WL-term for NOIA2	—	0
P2NTGEN	WL-term of NTGEN	m ²	0
P2NTOX	WL-term of NTOX	m ²	0
P2PCLM	WL-term of PCLM	m ²	0
P2PCLMCV	WL-term of PCLMCV	m ²	0
P2PCLMG	WL-term of PCLMG	—	0
P2PCLMR	WL-term of PCLMR	m ²	0
P2PDIBL1	WL-term of PDIBL1	m ²	0
P2PDIBL1R	WL-term of PDIBL1R	m ²	0
P2PDIBL2	WL-term of PDIBL2	m ²	0
P2PDIBL2R	WL-term of PDIBL2R	m ²	0
P2PGIDL	WL-term of PGIDL	m ²	0
P2PGIDLB	WL-term of PGIDLB	m ²	0
P2PGISL	WL-term of PGISL	m ²	0
P2PGISLB	WL-term of PGISLB	m ²	0
P2PHIBE	WL-term of PHIBE	—	0
P2PHIG	WL-term of PHIG	—	0
P2PHIN	WL-term of PHIN	—	0
P2PIGCD	WL-term of PIGCD	m ²	0
P2POXEDGE	WL-term of POXEDGE	m ²	0
P2PRT	WL-term of PRT	—	0
P2PRT1	WL-term of PRT1	—	0
P2PRWGD	WL-term of PRWGD	—	0
P2PRWGS	WL-term of PRWGS	—	0
P2PSAT	WL-term of PSAT	m ²	0
P2PSATCV	WL-term of PSATCV	m ²	0
P2PTWG	WL-term of PTWG	—	0
P2PTWGR	WL-term of PTWGR	—	0
P2PTWGT	WL-term of PTWGT	—	0
P2PVAG	WL-term of PVAG	m ²	0
P2QMFACTOR	WL-term of QMFACTOR	m ²	0
P2QMTCECV	WL-term of QMTCECV	m ²	0
P2QMTCECVVA	WL-term of QMTCECVVA	m ²	0
P2QSREF	WL-term for QSREF	m ²	0

Table 2-127. BSIM-CMG FINFET v111.2.1 Device Model Parameters

Parameter	Description	Units	Default
P2RDSW	WL-term of RDSW	—	0
P2RDW	WL-term of RDW	—	0
P2RSW	WL-term of RSW	—	0
P2SII0	WL-term of SII0	—	0
P2SII1	WL-term of SII1	m ²	0
P2SII2	WL-term of SII2	—	0
P2SIID	WL-term of SIID	—	0
P2SPRT	WL-term of SPRT	m ²	0
P2SSP1	WL-term of SSP1	m ²	0
P2SSP2	WL-term of SSP2	m ²	0
P2SSP3	WL-term of SSP3	m ²	0
P2TGIDL	WL-term of TGIDL	—	0
P2TII	WL-term of TII	m ²	0
P2TR0	WL-term of TR0	—	0
P2TSS	WL-term of TSS	—	0
P2U0	WL-term of U0	—	0
P2U0CV	WL-term of U0CV	—	0
P2U0R	WL-term of U0R	—	0
P2UA	WL-term of UA	—	0
P2UA1	WL-term of UA1	m ²	0
P2UA1CV	WL-term of UA1CV	m ²	0
P2UA1R	WL-term of UA1R	m ²	0
P2UA2	WL-term of UA2	m ²	0
P2UA2CV	WL-term of UA2CV	m ²	0
P2UACV	WL-term of UACV	—	0
P2UAR	WL-term of UAR	—	0
P2UC	WL-term of UC	—	0
P2UC1	WL-term of UC1	m ²	0
P2UC1CV	WL-term of UC1CV	m ²	0
P2UC1R	WL-term of UC1R	m ²	0
P2UCCV	WL-term of UCCV	—	0
P2UCR	WL-term of UCR	—	0
P2UCS	WL-term of UCS	m ²	0
P2UCSTE	WL-term of UCSTE	m ²	0
P2UCSTE1	WL-term of UCSTE1	m ²	0
P2UD	WL-term of UD	—	0

Table 2-127. BSIM-CMG FINFET v111.2.1 Device Model Parameters

Parameter	Description	Units	Default
P2UD1	WL-term of UD1	m ²	0
P2UD1CV	WL-term of UD1CV	m ²	0
P2UD1R	WL-term of UD1R	m ²	0
P2UD2	WL-term of UD2	m ²	0
P2UD2CV	WL-term of UD2CV	m ²	0
P2UDCV	WL-term of UDCV	—	0
P2UDD	WL-term of UDD	m ²	0
P2UDD1	WL-term of UDD1	m ²	0
P2UDR	WL-term of UDR	—	0
P2UDS	WL-term of UDS	m ²	0
P2UDS1	WL-term of UDS1	m ²	0
P2UP	WL-term of UP	—	0
P2UPR	WL-term of UPR	—	0
P2UTE	WL-term of UTE	m ²	0
P2UTE1	WL-term of UTE1	m ²	0
P2UTE1CV	WL-term of UTE1CV	m ²	0
P2UTE1R	WL-term of UTE1R	m ²	0
P2UTE1CV	WL-term of UTE1CV	m ²	0
P2UTER	WL-term of UTER	m ²	0
P2UTL	WL-term of UTL	m ²	0
P2UTLCV	WL-term of UTLCV	m ²	0
P2UTLR	WL-term of UTLR	m ²	0
P2VSAT	WL-term of VSAT	—	0
P2VSAT1	WL-term of VSAT1	—	0
P2VSAT1R	WL-term of VSAT1R	—	0
P2VSATCV	WL-term of VSATCV	—	0
P2VSATR	WL-term of VSATR	—	0
P2WR	WL-term of WR	m ²	0
P2XRCRG1	WL-term of XRCRG1	m ²	0
P2XRCRG2	WL-term of XRCRG2	m ²	0
P2XW	WL-term of XW	—	0
PA1	P-term of A1	—	0
PA11	P-term of A11	—	0
PA2	P-term of A2	m/V	0
PA21	P-term of A21	—	0
PAGIDL	P-term of AGIDL	—	0
PAGIDLB	P-term of AGIDLB	—	0

Table 2-127. BSIM-CMG FINFET v111.2.1 Device Model Parameters

Parameter	Description	Units	Default
PAGISL	P-term of AGISL	—	0
PAGISLB	P-term of AGISLB	—	0
PAIGBACC	P-term of AIGBACC	—	0
PAIGBACC1	P-term of AIGBACC1	—	0
PAIGBINV	P-term of AIGBINV	—	0
PAIGBINV1	P-term of AIGBINV1	—	0
PAIGC	P-term of AIGC	—	0
PAIGC1	P-term of AIGC1	—	0
PAIGD	P-term of AIGD	—	0
PAIGD1	P-term of AIGD1	—	0
PAIGEN	P-term of AIGEN	—	0
PAIGS	P-term of AIGS	—	0
PAIGS1	P-term of AIGS1	—	0
PALPHA0	P-term of ALPHA0	—	0
PALPHA1	P-term of ALPHA1	m/V	0
PALPHAI0	P-term of ALPHAI0	—	0
PALPHAI1	P-term of ALPHAI1	m/V	0
PAT	P-term of AT	—	0
PATCV	P-term of ATCV	—	0
PATR	P-term of ATR	—	0
PBD	Drain-side bulk junction built-in potential	V	0
PBETA0	P-term of BETA0	m/V	0
PBETAI0	P-term of BETAI0	m/V	0
PBETAI1	P-term of BETAI1	m	0
PBETAI2	P-term of BETAI2	—	0
PBGIDL	P-term of BGIDL	V	0
PBGIDLB	P-term of BGIDLB	V	0
PBGISL	P-term of BGISL	V	0
PBGISLB	P-term of BGISLB	V	0
PBIGBACC	P-term of BIGBACC	—	0
PBIGBINV	P-term of BIGBINV	—	0
PBIGC	P-term of BIGC	—	0
PBIGD	P-term of BIGD	—	0
PBIGEN	P-term of BIGEN	—	0
PBIGS	P-term of BIGS	—	0
PBS	Source-side bulk junction built-in potential	V	1

Table 2-127. BSIM-CMG FINFET v111.2.1 Device Model Parameters

Parameter	Description	Units	Default
PBSWD	Built-in potential for Drain-side sidewall junction capacitance	V	0
PBSWGD	Built-in potential for Drain-side gate sidewall junction capacitance	V	0
PBSWGS	Built-in potential for Source-side gate sidewall junction capacitance	V	0
PBSWS	Built-in potential for Source-side sidewall junction capacitance	V	1
PCDSC	P-term of CDSC	—	0
PCDSCD	P-term of CDSCD	—	0
PCDSCDR	P-term of CDSCDR	—	0
PCFD	P-term of CFD	F	0
PCFS	P-term of CFS	F	0
PCGBL	P-term of CGBL	F	0
PCGDL	P-term of CGDL	F	0
PCGIDL	P-term of CGIDL	—	0
PCGIDLB	P-term of CGIDLB	—	0
PCGISL	P-term of CGISL	—	0
PCGISLB	P-term of CGISLB	—	0
PCGSL	P-term of CGSL	F	0
PCIGBACC	P-term of CIGBACC	m/V	0
PCIGBINV	P-term of CIGBINV	m/V	0
PCIGC	P-term of CIGC	m/V	0
PCIGD	P-term of CIGD	m/V	0
PCIGS	P-term of CIGS	m/V	0
PCIT	P-term of CIT	—	0
PCITR	P-term of CITR	—	0
PCKAPPAB	P-term of CKAPPAB	—	0
PCKAPPAD	P-term of CKAPPAD	—	0
PCKAPPAS	P-term of CKAPPAS	—	0
PCLM	Channel length modulation (CLM) parameter	—	0.013
PCLMCV	CLM parameter for short-channel CV	—	0
PCLMG	Gate bias dependence parameter for CLM	V ⁻¹	0
PCLMR	Reverse model PCLM parameter	—	0
PCLMT	CRYOMOD != 0 temperature coefficient for PCLM	—	-2e-05
PCOVD	P-term of COVD	F	0
PCOVS	P-term of COVS	F	0

Table 2-127. BSIM-CMG FINFET v111.2.1 Device Model Parameters

Parameter	Description	Units	Default
PDEJ	Drain-to-substrate PN junction perimeter (BULKMOD = 1 or 2)	m	0
PDELTAVSAT	P-term of DELTAVSAT	m	0
PDELTAVSATCV	P-term of DELTAVSATCV	m	0
PDEO	Perimeter of drain-to-substrate overlap region through oxide	m	0
PDIBL1	DIBL output conductance parameter - forward mode	—	1.3
PDIBL1R	DIBL output conductance parameter - reverse mode	—	0
PDIBL2	DIBL output conductance parameter	—	0.0002
PDIBL2R	DIBL output conductance parameter - reverse mode	—	0
PDIMENSION1	P-term of DIMENSION1	m	0
PDIMENSION2	P-term of DIMENSION2	m	0
PDIMENSION3	P-term of DIMENSION3	m	0
PDLBIN	P-term of DLBIN	m ²	0
PDROUT	P-term of DROUT	m	0
PDSUB	P-term of DSUB	m	0
PDVT0	P-term of DVT0	m	0
PDVT1	P-term of DVT1	m	0
PDVT1SS	P-term of DVT1SS	m	0
PDVTP0	P-term of DVTP0	m	0
PDVTP1	P-term of DVTP1	m	0
PDVTSHIFT	P-term of DVTSHIFT	—	0
PDVTSHIFTR	P-term of DVTSHIFTR	—	0
PDWBIN	P-term of DWBIN	m ²	0
PE2NOM	P-term of E2NOM	—	0
PE3NOM	P-term of E3NOM	—	0
PEGIDL	P-term of EGIDL	—	0
PEGIDLB	P-term of EGIDLB	—	0
PEGISL	P-term of EGISL	—	0
PEGISLB	P-term of EGISLB	—	0
PEIGBINV	P-term of EIGBINV	—	0
PEMOBT	P-term of EMOBT	m	0
PESATII	P-term of ESATII	V	0
PETA0	P-term of ETA0	m	0
PETA0CV	P-term of ETA0CV	m	0
PETA0R	P-term of ETA0R	m	0

Table 2-127. BSIM-CMG FINFET v111.2.1 Device Model Parameters

Parameter	Description	Units	Default
PETAMOB	P-term of ETAMOB	m	0
PEU	P-term of EU	—	0
PEU1	P-term of EU1	m	0
PEUR	P-term of EUR	—	0
PGIDL	Parameter for body-bias effect on GIDL	—	1
PGIDLB	Parameter for body-bias effect on parasitic substrate GIDL	—	1
PGISL	Parameter for body-bias effect on GISL	—	0
PGISLB	Parameter for body-bias effect on parasitic substrate GISL	—	0
PHIBE	Body effect voltage parameter. After binning it should be within [0.2 : 1.2]	V	0.7
PHIG	Gate workfunction	—	4.61
PHIGL	Length dependence of gate workfunction	—	0
PHIGLT	Coupled NFIN and length dependence of gate workfunction	—	0
PHIGN1	NFIN dependence of gate workfunction	—	0
PHIGN2	NFIN dependence of gate workfunction	—	100000
PHIN	Nonuniform vertical doping effect on surface potential	V	0.05
PIGCD	Parameter for Igc partition	—	1
PIGT	P-term of IGT	m	0
PIIT	P-term of IIT	m	0
PK0	P-term of K0	—	0
PK01	P-term of K01	—	0
PK0SI	P-term of K0SI	m	0
PK0SI1	P-term of K0SI1	—	0
PK0SISAT	P-term of K0SISAT	m	0
PK0SISAT1	P-term of K0SISAT1	m	0
PK1	P-term of K1	—	0
PK11	P-term of K11	—	0
PK1RSCE	P-term of K1RSCE	—	0
PK2	P-term of K2	m	0
PK21	P-term of K21	m	0
PK2SAT	P-term of K2SAT	m	0
PK2SAT1	P-term of K2SAT1	m	0
PK2SI	P-term of K2SI	m	0
PK2SI1	P-term of K2SI1	—	0

Table 2-127. BSIM-CMG FINFET v111.2.1 Device Model Parameters

Parameter	Description	Units	Default
PK2SISAT	P-term of K2SISAT	m	0
PK2SISAT1	P-term of K2SISAT1	m	0
PKSATIV	P-term of KSATIV	m	0
PKSATIVR	P-term of KSATIVR	m	0
PKT1	P-term of KT1	—	0
PLII	P-term of LII	—	0
PLINT	P-term of LINT	m ²	0
PLPE0	P-term of LPE0	m ²	0
PMEXP	P-term of MEXP	m	0
PMEXPR	P-term of MEXPR	m	0
PMFQ1NOM	P-term of MFQ1NOM	m	0
PMFQ2NOM	P-term of MFQ2NOM	m	0
PMFQ3NOM	P-term of MFQ3NOM	m	0
PMPOWER	P-term for MPOWER	m	0
PNBODY	P-term of NBODY	—	0
PNGATE	P-term of NGATE	—	0
PNIGBACC	P-term of NIGBACC	m	0
PNIGBINV	P-term of NIGBINV	m	0
PNOIA2	P-term for NOIA2	—	0
PNTGEN	P-term of NTGEN	m	0
PNTOX	P-term of NTOX	m	0
POXEDGE	Factor for the gate edge Tox	—	1
PPCLM	P-term of PCLM	m	0
PPCLMCV	P-term of PCLMCV	m	0
PPCLMG	P-term of PCLMG	m/V	0
PPCLMR	P-term of PCLMR	m	0
PPDIBL1	P-term of PDIBL1	m	0
PPDIBL1R	P-term of PDIBL1R	m	0
PPDIBL2	P-term of PDIBL2	m	0
PPDIBL2R	P-term of PDIBL2R	m	0
PPGIDL	P-term of PGIDL	m	0
PPGIDLB	P-term of PGIDLB	m	0
PPGISL	P-term of PGISL	m	0
PPGISLB	P-term of PGISLB	m	0
PPHIBE	P-term of PHIBE	—	0
PPHIG	P-term of PHIG	—	0

Table 2-127. BSIM-CMG FINFET v111.2.1 Device Model Parameters

Parameter	Description	Units	Default
PPHIN	P-term of PHIN	—	0
PPIGCD	P-term of PIGCD	m	0
PPOXEDGE	P-term of POXEDGE	m	0
PPRT	P-term of PRT	—	0
PPRT1	P-term of PRT1	—	0
PPRWGD	P-term of PRWGD	m/V	0
PPRWGS	P-term of PRWGS	m/V	0
PPSAT	P-term of PSAT	m	0
PPSATCV	P-term of PSATCV	m	0
PPTWG	P-term of PTWG	—	0
PPTWGR	P-term of PTWGR	—	0
PPTWGT	P-term of PTWGT	—	0
PPVAG	P-term of PVAG	m	0
PQM	Slope of normalized Tcen in inversion	—	0.66
PQMACC	Slope of normalized Tcen in accumulation	—	0.66
PQMFACTOR	P-term of QMFACTOR	m	0
PQMTCENCV	P-term of QMTCENCV	m	0
PQMTCENCVA	P-term of QMTCENCVA	m	0
PQSREF	P-term for QSREF	m	0
PRDDR	Drain-side quasi-saturation parameter	—	0
PRDSW	P-term of RDSW	—	0
PRDW	P-term of RDW	—	0
PRSDEND	Extra silicon/silicide interface perimeter at the two ends of the finFET	m	0
PRSDR	Source-side quasi-saturation parameter	—	1
PRSW	P-term of RSW	—	0
PRT	Series resistance temperature coefficient	—	0.001
PRT1	CRYOMOD != 0 series resistance temperature coefficient at low temperatures	—	0.0004
PRTVSRSD	Temperature coefficient of resistance in S/D velocity saturation model	—	0
PRWGD	Gate bias dependence of drain extension resistance	V ⁻¹	0
PRWGS	Gate bias dependence of source extension resistance	V ⁻¹	0
PSAT	Velocity saturation exponent, after binning should be from [2.0 : inf)	—	2
PSATCV	Velocity saturation exponent for C-V	—	0
PSATXVSRSD	Fine tuning of PTWGVSRSD effect	V	60

Table 2-127. BSIM-CMG FINFET v111.2.1 Device Model Parameters

Parameter	Description	Units	Default
PSEJ	Source-to-substrate PN junction perimeter (BULKMOD = 1 or 2)	m	0
PSEO	Perimeter of source-to-substrate overlap region through oxide	m	0
PSII0	P-term of SII0	m/V	0
PSII1	P-term of SII1	m	0
PSII2	P-term of SII2	—	0
PSIID	P-term of SIID	—	0
PSPRT	P-term of SPRT	m	0
PSSP1	P-term of SSP1	m	0
PSSP2	P-term of SSP2	m	0
PSSP3	P-term of SSP3	m	0
PTGIDL	P-term of TGIDL	—	0
PTII	P-term of TII	m	0
PTR0	P-term of TR0	—	0
PTSS	P-term of TSS	—	0
PTWG	Gmsat degradation parameter - forward mode	—	0
PTWG1VSRSD	VSATRSD variation with gate bias	V	0
PTWGR	Gmsat degradation parameter - reverse mode	—	0
PTWGT	PTWG temperature coefficient	—	0.004
PTWGVSRSD	VSATRSD variation with gate bias	—	0
PU0	P-term of U0	—	0
PU0CV	P-term of U0CV	—	0
PU0R	P-term of U0R	—	0
PUA	P-term of UA	—	0
PUA1	P-term of UA1	m	0
PUA1CV	P-term of UA1CV	m	0
PUA1R	P-term of UA1R	m	0
PUA2	P-term of UA2	m	0
PUA2CV	P-term of UA2CV	m	0
PUACV	P-term of UACV	—	0
PUAR	P-term of UAR	—	0
PUC	P-term of UC	—	0
PUC1	P-term of UC1	m	0
PUC1CV	P-term of UC1CV	m	0
PUC1R	P-term of UC1R	m	0

Table 2-127. BSIM-CMG FINFET v111.2.1 Device Model Parameters

Parameter	Description	Units	Default
PUCCV	P-term of UCCV	—	0
PUCR	P-term of UCR	—	0
PUCS	P-term of UCS	m	0
PUCSTE	P-term of UCSTE	m	0
PUCSTE1	P-term of UCSTE1	m	0
PUD	P-term of UD	—	0
PUD1	P-term of UD1	m	0
PUD1CV	P-term of UD1CV	m	0
PUD1R	P-term of UD1R	m	0
PUD2	P-term of UD2	m	0
PUD2CV	P-term of UD2CV	m	0
PUDCV	P-term of UDCV	—	0
PUDD	P-term of UDD	m	0
PUDD1	P-term of UDD1	m	0
PUDR	P-term of UDR	—	0
PUDS	P-term of UDS	m	0
PUDS1	P-term of UDS1	m	0
PUP	P-term of UP	—	0
PUPR	P-term of UPR	—	0
PUTE	P-term of UTE	m	0
PUTE1	P-term of UTE1	m	0
PUTE1CV	P-term of UTE1CV	m	0
UTE1CV	P-term of UTECV	m	0
PUTER	P-term of UTER	m	0
PUTL	P-term of UTL	m	0
PUTLCV	P-term of UTLCV	m	0
PUTLR	P-term of UTLR	m	0
PVAG	Vgs dependence on early voltage	—	1
PVSAT	P-term of VSAT	—	0
PVSAT1	P-term of VSAT1	—	0
PVSAT1R	P-term of VSAT1R	—	0
PVSATCV	P-term of VSATCV	—	0
PVSATR	P-term of VSATR	—	0
PWR	P-term of WR	m	0
PXL	P-term of XL	m ²	0
PXRCRG1	P-term of XRCRG1	m	0

Table 2-127. BSIM-CMG FINFET v111.2.1 Device Model Parameters

Parameter	Description	Units	Default
PXRCRG2	P-term of XRCRG2	m	0
PXW	P-term of XW	m ²	0
QM0	Knee-point for Tcen in inversion (Charge normalized to Cox)	V	0.001
QM0ACC	Knee-point for Tcen in accumulation (Charge normalized to Cox)	V	0.001
QMFACTOR	Prefactor + switch for QM Vth correction	—	0
QMFACTORCV	Charge dependence taking QM effects into account	—	0
QMTCENCV	Prefactor + switch for QM Width and Toxeff correction for CV	—	0
QMTCENCVA	Prefactor + switch for QM Width and Toxeff correction for CV (accumulation region)	—	0
QSREF	Charge at threshold condition	—	0.05
RDDR	Drain-side drift resistance parameter - forward mode	—	0
RDDRR	Drain-side drift resistance parameter - reverse mode	—	0
RDLCW	'R'esistance of the 'D'rain region at 'L'ow 'C'urrent	—	0
RDSMOD	0: Bias-dependent S/D resistances internal and bias-independent S/D resistances external, 1: Both bias-dependent and independent of S/D resistances external, 2: Both bias-dependent and independent of S/D resistances internal	—	0
RDSW	RDSMOD = 0 zero bias S/D extension resistance per unit width	—	100
RDSWMIN	RDSMOD = 0 S/D extension resistance per unit width at high Vgs	—	0
RDVDS	Parameter for Isat_rd variation with drain voltage	V	8
RDW	RDSMOD = 1 zero bias drain extension resistance per unit width	—	50
RDWMIN	RDSMOD = 1 drain extension resistance per unit width at high Vgs	—	0
RGATEMOD	0: Turn off gate electrode resistance (without ge node); 1: Turn on gate electrode resistance (with ge node)	—	0
RGEOA	Fitting parameter for RGEOMOD = 1	—	1
RGEOB	Fitting parameter for RGEOMOD = 1	—	0
RGEOC	Fitting parameter for RGEOMOD = 1	—	0
RGEOD	Fitting parameter for RGEOMOD = 1	—	0
RGEOE	Fitting parameter for RGEOMOD = 1	—	0
RGEOMOD	Geometry-dependent source/drain resistance; 0: RSH-based; 1: Holistic	—	0
RGEXT	Effective gate electrode external resistance	—	0

Table 2-127. BSIM-CMG FINFET v111.2.1 Device Model Parameters

Parameter	Description	Units	Default
RGFIN	Effective gate electrode per finger per fin resistance	—	0.001
RHOC	Contact resistivity at the silicon/silicide interface	—	1e-12
RHORSD	If non-zero, average resistivity of silicon in the raised source/drain region	—	1
RNOIA	Empirical parameter for Sid level	—	0.5774
RNOIB	Empirical parameter for Sig level	—	0.3652
RNOIC	Empirical parameter for correlation coefficient	—	0.3953
RNOIK	Empirical parameter for Sid level at low Ids	—	0
RSDR	Source-side drift resistance parameter - forward mode	—	0
RSDRR	Source-side drift resistance parameter - reverse mode	—	0
RSHD	Drain-side sheet resistance	—	0
RSHS	Source-side sheet resistance	—	0
RSLCW	'R'esistance of the 'S'ource region at 'L'ow 'C'urrent	—	0
RSW	RDSMOD = 1 zero bias source extension resistance per unit width	—	50
RSWMIN	RDSMOD = 1 source extension resistance per unit width at high Vgs	—	0
RTH0	Thermal resistance	—	0.01
SDTERM	Indicator of whether the source/drain are terminated with silicide	—	0
SH_WARN	0: Disable self-heating warnings; 1: Enable self-heating warnings	—	0
SHMOD	0: Turn off self-heating; 1: Turn on self-heating	—	0
SII0	Vgs dependence parameter of Iii	V ⁻¹	0.5
SII1	1st Vgs dependence parameter of Iii	—	0.1
SII2	2nd Vgs dependence parameter of Iii	V	0
SIID	3rd Vds dependence parameter of Iii	V	0
SJD	Constant for drain-side two-step second junction	—	0
SJS	Constant for source-side two-step second junction	—	0
SJSWD	Constant for drain-side sidewall two-step second junction	—	0
SJSWGD	Constant for source-side gate sidewall two-step second junction	—	0
SJSWGS	Constant for source-side gate sidewall two-step second junction	—	0
SJSWS	Constant for source-side sidewall two-step second junction	—	0
SMOOTH	Smoothing Parameter	—	2

Table 2-127. BSIM-CMG FINFET v111.2.1 Device Model Parameters

Parameter	Description	Units	Default
SPRT	CRYOMOD != 0 parameter for corner temperature smoothing in dual-slope temperature model of series resistance	—	0.01
SSP1	Subband smoothing parameter for 1st subband (WGAA<WSSP0)	—	14
SSP2	Subband smoothing parameter for 2nd subband (WGAA<WSSP0)	—	24
SSP3	Subband smoothing parameter for 3rd subband (WGAA<WSSP0)	—	24
SUBBANDMOD	Switch for GAAFET quantum subband model (0: off; 1: on)	—	0
TBGASUB	Bandgap temperature coefficient	—	0.000702
TGBSUB	Bandgap temperature coefficient	K	1108
TCJ	Temperature coefficient for CJS/CJD	—	0
TCJSW	Temperature coefficient for CJSWS/CJSWD	—	0
TCJSWG	Temperature coefficient for CJSWGS/CJSWGD	—	0
TDWSE2	TGAA dependence of WGAA scaling for 2nd subband energy	—	1
TDWSE3	TGAA dependence of WGAA scaling for 3rd subband energy	—	0.23
TDWSQ1	TGAA dependence of WGAA scaling for 1st subband charge	—	2.4
TDWSQ2	TGAA dependence of WGAA scaling for 2nd subband charge	—	2
TDWSQ3	TGAA dependence of WGAA scaling for 3rd subband charge	—	2.4
TEMPMOD	1: Change temperature dependence of specific parameters	—	0
TETA0	Temperature dependence of DIBL coefficient	—	0
TETA0CV	CVMOD = 1 temperature dependence of DIBL coefficient	—	0
TETA0R	Temperature dependence of reverse-mode DIBL coefficient	—	0
TFIN	Fin thickness	m	1.5e-08
TFIN_BASE	If non-zero, base fin thickness for trapezoidal triple gate	m	0
TFIN_TOP	If non-zero, top fin thickness for trapezoidal triple gate	m	0
TGAA	Thickness of individual GAA bodies	m	5e-09
TGATE	Gate height on top of the hard mask	m	3e-08
TGIDL	GIDL/GISL temperature dependence	—	-0.003

Table 2-127. BSIM-CMG FINFET v111.2.1 Device Model Parameters

Parameter	Description	Units	Default
THETADIBL	User-designated DIBL length dependence.	—	0
THETASCE	User-designated V_{th} roll-off length dependence.	—	0
THETASW	User-designated subthreshold swing length dependence.	—	0
TII	Impact ionization temperature dependence for IIMOD = 2	—	0
TLOW	CRYOMOD != 0 transition temperature of subthreshold swing at low temperatures	K	50
TLOW1	CRYOMOD != 0 transition temperature of subthreshold swing at low temperatures	K	0
TMASK	Height of hard mask on top of the fin	m	3e-08
TMEXP	Temperature coefficient for V_{dseff} smoothing	—	0
TMEXP2	CRYOMOD != 0 temperature coefficient for V_{dseff} smoothing	—	-4e-06
TMEXPR	Reverse-mode temperature coefficient for V_{dseff} smoothing	—	0
TNJTS	Temperature coefficient for NJTS	—	0
TNJTSD	Temperature coefficient for NJTSD	—	0
TNJTSSW	Temperature coefficient for NJTSSW	—	0
TNJTSSWD	Temperature coefficient for NJTSSWD	—	0
TNJTSSWG	Temperature coefficient for NJTSSWG	—	0
TNJTSSWGD	Temperature coefficient for NJTSSWGD	—	0
TNOIA	Empirical parameter for L_{eff} trend of S_{id}	—	0
TNOIB	Empirical parameter for L_{eff} trend of σ	—	0
TNOIC	Empirical parameter for L_{eff} trend of correlation coefficient	—	0
TNOIK	Empirical parameter for L_{eff} trend of S_{id} at low I_{ds}	—	0
TNOIK2	Empirical parameter for sensitivity of RNOIK	—	0.1
TNOIMOD	0: Charge-based, 1: Correlated thermal noise model	—	0
TNOM	Temperature at which the model is extracted	°C	27
TOXG	Oxide thickness for gate current model	m	0
TOXP	Physical oxide thickness	m	1.2e-09
TOXREF	Target tox value	m	1.2e-09
TPB	Temperature coefficient for PBS/PBD	—	0
TPBSW	Temperature coefficient for PBSWS/PBSWD	—	0
TPBSWG	Temperature coefficient for PBSWGS/PBSWGD	—	0
TR0	CRYOMOD != 0 corner temperature in dual-slope temperature model of series resistance	K	170

Table 2-127. BSIM-CMG FINFET v111.2.1 Device Model Parameters

Parameter	Description	Units	Default
TRDDR	Drain-side drift resistance temperature coefficient	—	0
TRSDR	Source-side drift resistance temperature coefficient	—	0
TSILI	Thickness of the silicide on top of the raised source/drain	m	1e-08
TSRE2	TGAA scaling for 2nd subband energy	—	1.8
TSRE3	TGAA scaling for 3rd subband energy	—	0.67
TSRQ1	TGAA scaling for 1st subband charge	—	1.1
TSRQ2	TGAA scaling for 2nd subband charge	—	2
TSRQ3	TGAA scaling for 3rd subband charge	—	6
TSS	Swing temperature coefficient	—	0
TSUS	Separation between GAA bodies	m	2e-09
TVTH	CRYOMOD != 0 transition temperature for Vth temperature model	K	40
TYPE	1: NMOS; -1: PMOS	—	1
U0	Low-field mobility	—	0.03
U0CV	CVMOD = 1 low-field mobility	—	0
U0EMSM1	Parameter for effective mass scaling	—	26.6
U0EMSM2	Parameter for effective mass scaling	—	4
U0ETAWSC	Ratio of primary carrier low-field mobilities: U0_[110]/U0_[100]	—	1.5
U0LT	Coupled NFIN and length dependence of U0	—	0
U0LTCV	Coupled NFIN and length dependence of U0CV	—	0
U0MULT	Variability in carrier mobility	—	1
U0N1	NFIN dependence of U0	—	0
U0N1CV	CVMOD = 1 NFIN dependence of U0CV	—	0
U0N1R	Reverse-mode NFIN dependence of U0	—	0
U0N2	NFIN dependence of U0	—	100000
U0N2CV	CVMOD=1 NFIN dependence of U0CV	—	0
U0N2R	Reverse-mode NFIN dependence of U0	—	0
U0R	Reverse-mode low-field mobility	—	0
UA	Phonon/surface roughness scattering parameter	—	0.3
UA1	Mobility temperature coefficient for UA	—	0.001032
UA1CV	CVMOD = 1 mobility temperature coefficient for UA	—	0
UA1R	Reverse-mode mobility temperature coefficient for UA	—	0
UA2	CRYOMOD != 0 mobility temperature coefficient for UA	—	-0.04

Table 2-127. BSIM-CMG FINFET v111.2.1 Device Model Parameters

Parameter	Description	Units	Default
UA2CV	CRYOMOD != 0 and CVMOD = 1 mobility temperature coefficient for UA	—	0
UACV	CVMOD = 1 phonon/surface roughness scattering parameter	—	0
UAIR	Ideality parameter	—	0.2
UAR	Reverse-mode phonon/surface roughness scattering parameter	—	0
UARTSC	Rate of UA decay with TGAA scaling	—	0.09
UATHIN	Phonon/surface roughness scattering parameter for thin GAA bodies	—	0
UATNI	Critical TGAA for non-ideality	m	6.4e-09
UATSAT	Critical TGAA for UA saturation	m	9e-09
UC	Body effect for mobility degradation parameter - BULKMOD = 1 or 2	—	0
UC1	Mobility temperature coefficient for UC	—	5.6e-11
UC1CV	CVMOD = 1 mobility temperature coefficient for UC	—	0
UC1R	Reverse-mode mobility temperature coefficient for UC	—	0
UCCV	CVMOD = 1 body effect for mobility degradation parameter (BULKMOD = 1 or 2)	—	0
UCR	Reverse-mode body effect for mobility degradation parameter - BULKMOD = 1 or 2	—	0
UCS	Coulomb scattering parameter	—	1
UCSTE	Mobility temperature coefficient	—	-0.004775
UCSTE1	CRYOMOD != 0 mobility temperature coefficient for UCS	—	-0.04
UD	Coulomb scattering parameter	—	0
UD1	Mobility temperature coefficient for UD	—	0
UD1CV	CVMOD = 1 mobility temperature coefficient for UD	—	0
UD1R	Reverse-mode mobility temperature coefficient for UD	—	0
UD2	CRYOMOD != 0 mobility temperature coefficient for UD	—	-0.04
UD2CV	CRYOMOD != 0 and CVMOD = 1 mobility temperature coefficient for UD	—	0
UDCV	CVMOD = 1 coulomb scattering parameter	—	0
UDD	CRYOMOD != 0 weight factor correction for drain side inversion charge density in Coulomb scattering model	—	-2e-05
UDD1	CRYOMOD != 0 temperature coefficient for UDD	—	-10
UDPTSC	Exponent for UD power law	—	1.3

Table 2-127. BSIM-CMG FINFET v111.2.1 Device Model Parameters

Parameter	Description	Units	Default
UDR	Reverse-mode Coulomb scattering parameter	—	0
UDS	CRYOMOD != 0 weight factor correction for source side inversion charge density in Coulomb scattering model	—	2e-05
UDS1	CRYOMOD != 0 temperature coefficient for UDS	—	-10
UDTHIN	Coulomb scattering parameter for thin GAA bodies	—	0
UDTSAT	Critical TGAA for UD saturation	m	8.1e-09
UP	Mobility L coefficient	—	0
UPR	Reverse-mode mobility L coefficient	—	0
UTE	Mobility temperature coefficient	—	0
UTE1	CRYOMOD != 0 mobility temperature coefficient	—	-0.4
UTE1CV	CRYOMOD != 0 and CVMOD = 1 mobility temperature coefficient	—	0
UTE1CV	CVMOD = 1 mobility temperature coefficient	—	0
UTER	Reverse-mode for mobility temperature coefficient	—	0
UTL	Mobility temperature coefficient	—	-0.0015
UTLCV	CVMOD = 1 mobility temperature coefficient	—	0
UTLR	Reverse-mode for mobility temperature coefficient	—	0
VFBSD	User-designated flatband voltage for S/D region	V	0
VFBSDCV	User-designated flatband voltage for S/D region for C-V calculations	V	0
VSAT	Saturation velocity for the saturation region	—	85000
VSAT1	Velocity saturation parameter for Ion degradation - forward mode	—	0
VSAT1N1	NFIN dependence of VSAT1	—	0
VSAT1N2	NFIN dependence of VSAT1	—	0
VSAT1R	Velocity saturation parameter for Ion degradation - reverse mode	—	0
VSAT1RN1	NFIN dependence of VSAT1R	—	0
VSAT1RN2	NFIN dependence of VSAT1R	—	0
VSATCV	Velocity saturation parameter for CV	—	0
VSATN1	NFIN dependence of VSAT	—	0
VSATN2	NFIN dependence of VSAT	—	100000
VSATR	Saturation velocity for the saturation region in the reverse mode	—	0
VSATRSR	Saturation velocity in S/D region	—	100000
VSRDFACTOR	Parameter for delta_vsrd tuning	—	0.001
VSRSFATOR	Parameter for delta_vsrs tuning	—	0.001

Table 2-127. BSIM-CMG FINFET v111.2.1 Device Model Parameters

Parameter	Description	Units	Default
VTSD	Bottom drain junction trap-assisted current voltage dependent parameter	V	0
VTSS	Bottom source junction trap-assisted current voltage dependent parameter	V	10
VTSSWD	Unit length trap-assisted current voltage dependent parameter for sidewall drain junction	V	0
VTSSWGD	Unit length trap-assisted current voltage dependent parameter for gate-edge sidewall drain junction	V	0
VTSSWGS	Unit length trap-assisted current voltage dependent parameter for gate-edge sidewall source junction	V	10
VTSSWS	Unit length trap-assisted current voltage dependent parameter for sidewall source junction	V	10
W_UFCM	Effective channel width for the unified model	m	1
WA1	W-term of A1	—	0
WA11	W-term of A11	—	0
WA2	W-term of A2	m/V	0
WA21	W-term of A21	—	0
WAGIDL	W-term of AGIDL	—	0
WAGIDLB	W-term of AGIDLB	—	0
WAGISL	W-term of AGISL	—	0
WAGISLB	W-term of AGISLB	—	0
WAIGBACC	W-term of AIGBACC	—	0
WAIGBACC1	W-term of AIGBACC1	—	0
WAIGBINV	W-term of AIGBINV	—	0
WAIGBINV1	W-term of AIGBINV1	—	0
WAIGC	W-term of AIGC	—	0
WAIGC1	W-term of AIGC1	—	0
WAIGD	W-term of AIGD	—	0
WAIGD1	W-term of AIGD1	—	0
WAIGEN	W-term of AIGEN	—	0
WAIGS	W-term of AIGS	—	0
WAIGS1	W-term of AIGS1	—	0
WALPHA0	W-term of ALPHA0	—	0
WALPHA1	W-term of ALPHA1	m/V	0
WALPHAI0	W-term of ALPHAI0	—	0
WALPHAI1	W-term of ALPHAI1	m/V	0
WAT	W-term of AT	—	0
WATCV	W-term of ATCV	—	0

Table 2-127. BSIM-CMG FINFET v111.2.1 Device Model Parameters

Parameter	Description	Units	Default
WATR	W-term of ATR	—	0
WBETA0	W-term of BETA0	m/V	0
WBETAI0	W-term of BETAI0	m/V	0
WBETAI1	W-term of BETAI1	m	0
WBETAI2	W-term of BETAI2	—	0
WBGIDL	W-term of BGIDL	V	0
WBGIDLB	W-term of BGIDLB	V	0
WBGISL	W-term of BGISL	V	0
WBGISLB	W-term of BGISLB	V	0
WBIGBACC	W-term of BIGBACC	—	0
WBIGBINV	W-term of BIGBINV	—	0
WBIGC	W-term of BIGC	—	0
WBIGD	W-term of BIGD	—	0
WBIGEN	W-term of BIGEN	—	0
WBIGS	W-term of BIGS	—	0
WCDSC	W-term of CDSC	—	0
WCDSCD	W-term of CDSCD	—	0
WCDSCDR	W-term of CDSCDR	—	0
WCFD	W-term of CFD	F	0
WCFS	W-term of CFS	F	0
WCGBL	W-term of CGBL	F	0
WCGDL	W-term of CGDL	F	0
WCGIDL	W-term of CGIDL	—	0
WCGIDLB	W-term of CGIDLB	—	0
WCGISL	W-term of CGISL	—	0
WCGISLB	W-term of CGISLB	—	0
WCGSL	W-term of CGSL	F	0
WCIGBACC	W-term of CIGBACC	m/V	0
WCIGBINV	W-term of CIGBINV	m/V	0
WCIGC	W-term of CIGC	m/V	0
WCIGD	W-term of CIGD	m/V	0
WCIGS	W-term of CIGS	m/V	0
WCIT	W-term of CIT	—	0
WCITR	W-term of CITR	—	0
WCKAPPAB	W-term of CKAPPAB	—	0
WCKAPPAD	W-term of CKAPPAD	—	0

Table 2-127. BSIM-CMG FINFET v111.2.1 Device Model Parameters

Parameter	Description	Units	Default
WCKAPPAS	W-term of CKAPPAS	—	0
WCOVD	W-term of COVD	F	0
WCOVS	W-term of COVS	F	0
WDELTAVSAT	W-term of DELTAVSAT	m	0
WDELTAVSATCV	W-term of DELTAVSATCV	m	0
WDIM0	WGAA at which dimension change happens	m	9.5e-09
WDIMENSION1	W-term of DIMENSION1	m	0
WDIMENSION2	W-term of DIMENSION2	m	0
WDIMENSION3	W-term of DIMENSION3	m	0
WDIMR	Rate of dimension change with WGAA scaling	—	0.1
WDROUT	W-term of DROUT	m	0
WDSUB	W-term of DSUB	m	0
WDVT0	W-term of DVT0	m	0
WDVT1	W-term of DVT1	m	0
WDVT1SS	W-term of DVT1SS	m	0
WDVTP0	W-term of DVTP0	m	0
WDVTP1	W-term of DVTP1	m	0
WDVTSHIFT	W-term of DVTSHIFT	—	0
WDVTSHIFTR	W-term of DVTSHIFTR	—	0
WDWBIN	W-term of DWBIN	m ²	0
WE2NOM	W-term of E2NOM	—	0
WE3NOM	W-term of E3NOM	—	0
WEGIDL	W-term of EGIDL	—	0
WEGIDLB	W-term of EGIDLB	—	0
WEGISL	W-term of EGISL	—	0
WEGISLB	W-term of EGISLB	—	0
WEIGBINV	W-term of EIGBINV	—	0
WEMOBT	W-term of EMOBT	m	0
WESATII	W-term of ESATII	V	0
WETA0	W-term of ETA0	m	0
WETA0CV	W-term of ETA0CV	m	0
WETA0R	W-term of ETA0R	m	0
WETAMOB	W-term of ETAMOB	m	0
WEU	W-term of EU	—	0
WEU1	W-term of EU1	m	0
WEUR	W-term of EUR	—	0

Table 2-127. BSIM-CMG FINFET v111.2.1 Device Model Parameters

Parameter	Description	Units	Default
WGAA	GAA body width	m	6e-09
WGAANOM	Nominal WGAA	m ²	8e-09
WIGT	W-term of IGT	m	0
WIIT	W-term of IIT	m	0
WK0	W-term of K0	—	0
WK01	W-term of K01	—	0
WK0SI	W-term of K0SI	m	0
WK0SI1	W-term of K0SI1	—	0
WK0SISAT	W-term of K0SISAT	m	0
WK0SISAT1	W-term of K0SISAT1	m	0
WK1	W-term of K1	—	0
WK11	W-term of K11	—	0
WK1RSCE	W-term of K1RSCE	—	0
WK2	W-term of K2	m	0
WK21	W-term of K21	m	0
WK2SAT	W-term of K2SAT	m	0
WK2SAT1	W-term of K2SAT1	m	0
WK2SI	W-term of K2SI	m	0
WK2SI1	W-term of K2SI1	—	0
WK2SISAT	W-term of K2SISAT	m	0
WK2SISAT1	W-term of K2SISAT1	m	0
WKSATIV	W-term of KSATIV	m	0
WKSATIVR	W-term of KSATIVR	m	0
WKT1	W-term of KT1	—	0
WLII	W-term of LII	—	0
WLPE0	W-term of LPE0	m ²	0
WMAX	Maximum width for which this model should be used	m	100
WMEXP	W-term of MEXP	m	0
WMEXPR	W-term of MEXPR	m	0
WMFQ1NOM	W-term of MFQ1NOM	m	0
WMFQ2NOM	W-term of MFQ2NOM	m	0
WMFQ3NOM	W-term of MFQ3NOM	m	0
WMIN	Minimum width for which this model should be used	m	0
WMPower	W-term for MPOWER	m	0
WNGATE	W-term of NGATE	—	0
WNIGBACC	W-term of NIGBACC	m	0

Table 2-127. BSIM-CMG FINFET v111.2.1 Device Model Parameters

Parameter	Description	Units	Default
WNIGBINV	W-term of NIGBINV	m	0
WNOIA2	W-term for NOIA2	—	0
WNTGEN	W-term of NTGEN	m	0
WNTOX	W-term of NTOX	m	0
WPCLM	W-term of PCLM	m	0
WPCLMCV	W-term of PCLMCV	m	0
WPCLMG	W-term of PCLMG	m/V	0
WPCLMR	W-term of PCLMR	m	0
WPDIBL1	W-term of PDIBL1	m	0
WPDIBL1R	W-term of PDIBL1R	m	0
WPDIBL2	W-term of PDIBL2	m	0
WPDIBL2R	W-term of PDIBL2R	m	0
WPGIDL	W-term of PGIDL	m	0
WPGIDLB	W-term of PGIDLB	m	0
WPGISL	W-term of PGISL	m	0
WPGISLB	W-term of PGISLB	m	0
WPHIBE	W-term of PHIBE	—	0
WPHIG	W-term of PHIG	—	0
WPHIN	W-term of PHIN	—	0
WPIGCD	W-term of PIGCD	m	0
WPOXEDGE	W-term of POXEDGE	m	0
WPRT	W-term of PRT	—	0
WPRT1	W-term of PRT1	—	0
WPRWGD	W-term of PRWGD	m/V	0
WPRWGS	W-term of PRWGS	m/V	0
WPSAT	W-term of PSAT	m	0
WPSATCV	W-term of PSATCV	m	0
WPTWG	W-term of PTWG	—	0
WPTWGR	W-term of PTWGR	—	0
WPTWGT	W-term of PTWGT	—	0
WPVAG	W-term of PVAG	m	0
WQMFACOR	W-term of QMFACOR	m	0
WQMTCENCV	W-term of QMTCENCV	m	0
WQMTCENCVA	W-term of QMTCENCVA	m	0
WQSREF	W-term for QSREF	m	0
WR	W dependence parameter of S/D extension resistance	—	1

Table 2-127. BSIM-CMG FINFET v111.2.1 Device Model Parameters

Parameter	Description	Units	Default
WRDSW	W-term of RDSW	—	0
WRDW	W-term of RDW	—	0
WRSW	W-term of RSW	—	0
WSFE2	WGAA scaling factor for 2nd subband energy	—	1
WSFE3	WGAA scaling factor for 3rd subband energy	—	1
WSFQ1	WGAA scaling factor for 1st subband charge	—	1
WSFQ2	WGAA scaling factor for 2nd subband charge	—	1
WSFQ3	WGAA scaling factor for 3rd subband charge	—	1
WSII0	W-term of SII0	m/V	0
WSII1	W-term of SII1	m	0
WSII2	W-term of SII2	—	0
WSIID	W-term of SIID	—	0
WSPRT	W-term of SPRT	m	0
WSSP0	WGAA around which SSP change happens	m	0
WSSP1	W-term of SSP1	m	0
WSSP2	W-term of SSP2	m	0
WSSP3	W-term of SSP3	m	0
WSSPR	Rate of SSP change with WGAA scaling	—	0
WTGIDL	W-term of TGIDL	—	0
WTH0	Width dependence coefficient for Rth and Cth	m	0
WTII	W-term of TII	m	0
WTR0	W-term of TR0	—	0
WTSS	W-term of TSS	—	0
WU0	W-term of U0	—	0
WU0CV	W-term of U0CV	—	0
WU0R	W-term of U0R	—	0
WUA	W-term of UA	—	0
WUA1	W-term of UA1	m	0
WUA1CV	W-term of UA1CV	m	0
WUA1R	W-term of UA1R	m	0
WUA2	W-term of UA2	m	0
WUA2CV	W-term of UA2CV	m	0
WUACV	W-term of UACV	—	0
WUAR	W-term of UAR	—	0
WUC	W-term of UC	—	0
WUC1	W-term of UC1	m	0

Table 2-127. BSIM-CMG FINFET v111.2.1 Device Model Parameters

Parameter	Description	Units	Default
WUC1CV	W-term of UC1CV	m	0
WUC1R	W-term of UC1R	m	0
WUCCV	W-term of UCCV	—	0
WUCR	W-term of UCR	—	0
WUCS	W-term of UCS	m	0
WUCSTE	W-term of UCSTE	m	0
WUCSTE1	W-term of UCSTE1	m	0
WUD	W-term of UD	—	0
WUD1	W-term of UD1	m	0
WUD1CV	W-term of UD1CV	m	0
WUD1R	W-term of UD1R	m	0
WUD2	W-term of UD2	m	0
WUD2CV	W-term of UD2CV	m	0
WUDCV	W-term of UDCV	—	0
WUDD	W-term of UDD	m	0
WUDD1	W-term of UDD1	m	0
WUDR	W-term of UDR	—	0
WUDS	W-term of UDS	m	0
WUDS1	W-term of UDS1	m	0
WUP	W-term of UP	—	0
WUPR	W-term of UPR	—	0
WUTE	W-term of UTE	m	0
WUTE1	W-term of UTE1	m	0
WUTE1CV	W-term of UTE1CV	m	0
WUTEKV	W-term of UTEKV	m	0
WUTER	W-term of UTER	m	0
WUTL	W-term of UTL	m	0
WUTLCV	W-term of UTLCV	m	0
WUTLR	W-term of UTLR	m	0
WVSAT	W-term of VSAT	—	0
WVSAT1	W-term of VSAT1	—	0
WVSAT1R	W-term of VSAT1R	—	0
WVSATCV	W-term of VSATCV	—	0
WVSATR	W-term of VSATR	—	0
WWR	W-term of WR	m	0
WXRCRG1	W-term of XRCRG1	m	0

Table 2-127. BSIM-CMG FINFET v111.2.1 Device Model Parameters

Parameter	Description	Units	Default
WXRCRG2	W-term of XRCRG2	m	0
WXW	W-term of XW	m ²	0
XJBVD	Fitting parameter for drain diode breakdown current	—	0
XJBVS	Fitting parameter for source diode breakdown current	—	1
XRCRG1	Parameter for non-quasistatic gate resistance NQSMOD = 1, 2	—	12
XRCRG2	Parameter for non-quasistatic gate resistance NQSMOD = 1, 2	—	1
XTID	Drain junction current temperature exponent	—	0
XTIS	Source junction current temperature exponent	—	3
XTSD	Power dependence of JTSD on temperature	—	0
XTSS	Power dependence of JTSS on temperature	—	0.02
XTSSWD	Power dependence of JTSSWD on temperature	—	0
XTSSWGD	Power dependence of JTSSWGD on temperature	—	0
XTSSWGS	Power dependence of JTSSWGS on temperature	—	0.02
XTSSWS	Power dependence of JTSSWS on temperature	—	0.02

Table 2-128. MOSFET level 111 Output Variables

Parameter	Description	Units	Default
WEFF	Effective width for I-V	m	none
LEFF	Effective length for I-V	m	none
WEFFCV	Effective width for C-V	m	none
LEFFCV	Effective length for C-V	m	none
IDS	Intrinsic drain current	A	none
IDEFF	Total drain current	A	none
ISEFF	Total source current	A	none
IGTOT	Total gate current	A	none
IDSGEN	Generation-recombination current	A	none
III	Impact ionization current	A	none
IGIDL	GIDL current	A	none
IGISL	GISL current	A	none
IJSB	Source-to-substrate junction current	A	none
IJDB	Drain-to-substrate junction current	A	none
ISUB	Substrate current	A	none
BETA	Drain current prefactor per fin per finger	A/V ²	none

Table 2-128. MOSFET level 111 Output Variables

Parameter	Description	Units	Default
VDSSAT	Drain-to-source saturation voltage	V	none
VDSEFF	Effective drain-to-source voltage	V	none
VFB	Flatband voltage	V	none
VTH	Threshold voltage	V	none
GM	Transconductance	A/V	none
GDS	Output conductance	A/V	none
GMBS	Substrate conductance	A/V	none
QGI	Intrinsic gate charge	C	none
QDI	Intrinsic drain charge	C	none
QSI	Intrinsic source charge	C	none
QBI	Intrinsic substrate charge	C	none
QG	Total gate charge	C	none
QD	Total drain charge	C	none
QS	Total source charge	C	none
QB	Total substrate charge	C	none
CGGI	Intrinsic gate capacitance	F	none
CGSI	Intrinsic gate-to-source capacitance	F	none
CGDI	Intrinsic gate-to-drain capacitance	F	none
CGEI	Intrinsic gate-to-substrate capacitance	F	none
CDGI	Intrinsic drain-to-gate capacitance	F	none
CDDI	Intrinsic drain capacitance	F	none
CDSI	Intrinsic drain-to-source capacitance	F	none
CDEI	Intrinsic drain-to-substrate capacitance	F	none
CSGI	Intrinsic source-to-gate capacitance	F	none
CSDI	Intrinsic source-to-drain capacitance	F	none
CSSI	Intrinsic source capacitance	F	none
CSEI	Intrinsic source-to-substrate capacitance	F	none
CEGI	Intrinsic substrate-to-gate capacitance	F	none
CEDI	Intrinsic substrate-to-drain capacitance	F	none
CESI	Intrinsic substrate-to-source capacitance	F	none
CEEI	Intrinsic substrate capacitance	F	none
CGG	Total gate capacitance	F	none
CGS	Total gate-to-source capacitance	F	none
CGD	Total gate-to-drain capacitance	F	none
CGE	Total gate-to-substrate capacitance	F	none
CDG	Total drain-to-gate capacitance	F	none

Table 2-128. MOSFET level 111 Output Variables

Parameter	Description	Units	Default
CDD	Total drain capacitance	F	none
CDS	Total drain-to-source capacitance	F	none
CDE	Total drain-to-substrate capacitance	F	none
CSG	Total source-to-gate capacitance	F	none
CSD	Total source-to-drain capacitance	F	none
CSS	Total source capacitance	F	none
CSE	Total source-to-substrate capacitance	F	none
CEG	Total substrate-to-gate capacitance	F	none
CED	Total substrate-to-drain capacitance	F	none
CES	Total substrate-to-source capacitance	F	none
CEE	Total substrate capacitance	F	none
CGSEXT	External gate-to-source capacitance	F	none
CGDEXT	External gate-to-drain capacitance	F	none
CGBOV	Gate-to-substrate overlap capacitance	F	none
CJST	Total junction and source-to-substrate capacitance	F	none
CJDT	Total junction and drain-to-substrate capacitance	F	none
RSCEO	External bias-independent source resistance	Ohm	none
RDCEO	External bias-independent drain resistance	Ohm	none
CFGEO	Geometric parasitic capacitance	F	none
T_TOTAL_K	Device temperature in Kelvin	K	none
T_TOTAL_C	Device temperature in Celsius	degC	none
T_DELTA_SH	Delta temperature by self-heating	K or degC	none
IGS	Gate-to-source tunneling current	A	none
IGD	Gate-to-drain tunneling current	A	none
IGCS	Gate-to-channel tunneling current at source	A	none
IGCD	Gate-to-channel tunneling current at drain	A	none
IGBS	Gate-to-substrate tunneling current at source	A	none
IGBD	Gate-to-substrate tunneling current at drain	A	none
IGBACC	Gate-to-substrate tunneling current in accumulation	A	none
IGBINV	Gate-to-substrate tunneling current in inversion	A	none
DIDSVDG	dI_{ds} / dV_g	A/V	none
DIDSDVS	dI_{ds} / dV_s	A/V	none
DIDSVDV	dI_{ds} / dV_d	A/V	none
DIGSDVG	dI_{gs} / dV_g	A/V	none
DIGSDVS	dI_{gs} / dV_s	A/V	none

Table 2-128. MOSFET level 111 Output Variables

Parameter	Description	Units	Default
DIGSDVD	dI_{gs} / dV_d	A/V	none
DIGDDVG	dI_{gd} / dV_g	A/V	none
DIGDDVS	dI_{gd} / dV_s	A/V	none
DIGDDVD	dI_{gd} / dV_d	A/V	none
DIIDVG	dI_{ii} / dV_g	A/V	none
DIIDVS	dI_{ii} / dV_s	A/V	none
DIIDVD	dI_{ii} / dV_d	A/V	none
DIGIDLVG	dI_{gidl} / dV_g	A/V	none
DIGIDLVS	dI_{gidl} / dV_s	A/V	none
DIGIDLVD	dI_{gidl} / dV_d	A/V	none
DIGISLVG	dI_{gisl} / dV_g	A/V	none
DIGISLVS	dI_{gisl} / dV_s	A/V	none
DIGISLVD	dI_{gisl} / dV_d	A/V	none
CGT	$dQ_g / dTemp$	C/K	none
CST	$dQ_s / dTemp$	C/K	none
CDT	$dQ_d / dTemp$	C/K	none
DIDSDVTH	$dI_{ds} / dTemp$	A/K	none
DIGSDVTH	$dI_{gs} / dTemp$	A/K	none
DIGDDVTH	$dI_{gd} / dTemp$	A/K	none
DIIDVTH	$dI_{ii} / dTemp$	A/K	none
DIGIDLVTH	$dI_{gidl} / dTemp$	A/K	none
DIGISLVTH	$dI_{gisl} / dTemp$	A/K	none
ITH	Device power	A*V	none
DITHDVTH	$dPower / dTemp$	A*V/K	none
DITHDVG	$dPower / dV_g$	A	none
DITHDVS	$dPower / dV_s$	A	none
DITHDVD	$dPower / dV_d$	A	none
VDSAT	Synonym for VDSSAT	V	none
VDS	Drain-source voltage	V	none
VGS	Gate-source voltage	V	none
VBS	Bulk-source voltage	V	none

2.3.20.14. Level 110 MOSFET Tables (BSIM CMG version 110.0.0)

Xyce includes the legacy BSIM CMG Common Multi-gate model versions 110. This model has been superseded by the level 111 version, but has been retained for backward compatibility with previous versions of Xyce and older model cards and PDKs. The code in Xyce was generated from the BSIM group's

Verilog-A input using the default “ifdef” lines provided, and therefore supports only the subset of BSIM CMG features those defaults enable. Instance and model parameters for the BSIM CMG model are given in tables 2-129 and 2-130. Details of the model are documented in the BSIM-CMG technical report[30], available from the BSIM web site at <http://bsim.berkeley.edu/models/bsimcmg/>.

The BSIM CMG devices support output of the internal variables in tables 2-134, 2-137, and 2-131 on the .PRINT line of a netlist. To access them from a print line, use the syntax N(<instance>:<variable>) where “<instance>” refers to the name of the specific level 107 or 108 M device in your netlist.

Table 2-129. BSIM-CMG FINFET v110.0.0 Device Instance Parameters

Parameter	Description	Units	Default
ADEJ	Drain junction area (BULKMOD=1 or 2)	m ²	0
ADEO	Drain-to-substrate overlap area through oxide	m ²	0
ASEJ	Source junction area (BULKMOD=1 or 2)	m ²	0
ASEO	Source-to-substrate overlap area through oxide	m ²	0
CDSP	Constant drain-to-source fringe capacitance (all CGEOMOD)	F	0
CGDP	Constant gate-to-drain fringe capacitance (CGEOMOD=1)	—	0
CGSP	Constant gate-to-source fringe capacitance (CGEOMOD=1)	—	0
COVD	Constant gate-to-drain overlap capacitance (CGEOMOD=1)	—	0
COVS	Constant gate-to-source overlap capacitance (CGEOMOD=1)	—	0
D	Diameter of the cylinder (GEOMOD=3)	m	4e-08
FPITCH	Fin pitch	m	8e-08
L	Designed gate length	m	3e-08
LRSD	Length of the source/drain	m	0
M	multiplicity factor	—	1
NF	Number of fingers	—	1
NFIN	Number of fins per finger (real number enables optimization)	—	1
NFINNOM	Nominal number of fins per finger	—	1
NGCON	Number of gate contact (1 or 2 sided)	—	1
NRD	Number of source diffusion squares	—	0
NRS	Number of source diffusion squares	—	0
PDEJ	Drain-to-substrate PN junction perimeter (BULKMOD=1 or 2)	m	0
PDEO	Perimeter of drain-to-substrate overlap region through oxide	m	0
PSEJ	Source-to-substrate PN junction perimeter (BULKMOD=1 or 2)	m	0

Table 2-129. BSIM-CMG FINFET v110.0.0 Device Instance Parameters

Parameter	Description	Units	Default
PSEO	Perimeter of source-to-substrate overlap region through oxide	m	0
TFIN	Body (fin) thickness	m	1.5e-08

Table 2-130. BSIM-CMG FINFET v110.0.0 Device Model Parameters

Parameter	Description	Units	Default
A1	Non-saturation effect parameter for strong inversion Region	—	0
A11	Temperature dependence of A1	—	0
A2	Non-saturation effect parameter for moderate Inversion Region	—	0
A21	Temperature dependence of A2	—	0
ACH_UFCM	Area of the channel for the unified Model	m ²	1
ADEJ	Drain junction area (BULKMOD=1 or 2)	m ²	0
ADEO	Drain-to-substrate overlap area through oxide	m ²	0
ADVTP0	Pre-exponential coefficient for DITS	—	0
ADVTP1	Pre-exponential coefficient for DVTP1	—	0
AEU	Pre-exponential coefficient for EU	—	0
AEUR	Reverse-mode pre-exponential coefficient for EU	—	0
AGIDL	Pre-exponential coefficient for GIDL	—	0
AGISL	Pre-exponential coefficient for GISL	—	6.055e-12
AIGBACC	Parameter for Igb in accumulation	—	0.0136
AIGBACC1	Parameter for Igb in accumulation	—	0
AIGBINV	Parameter for Igb in inversion	—	0.0111
AIGBINV1	Parameter for Igb in inversion	—	0
AIGC	Parameter for Igc in inversion	—	0.0136
AIGC1	Parameter for Igc in inversion	—	0
AIGD	Parameter for Igd in inversion	—	0
AIGD1	Parameter for Igd in inversion	—	0
AIGEN	Thermal generation current parameter	—	0
AIGS	Parameter for Igs in inversion	—	0.0136
AIGS1	Parameter for Igs in inversion	—	0
ALPHA0	First parameter of Iii	m/V	0
ALPHA01	Temperature dependence of ALPHA0	—	0
ALPHA1	L scaling parameter of Iii	V ⁻¹	0
ALPHA11	Temperature dependence ALPHA1	—	0

Table 2-130. BSIM-CMG FINFET v110.0.0 Device Model Parameters

Parameter	Description	Units	Default
ALPHA_UFCM	Mobile charge scaling term taking QM effects into account	—	0.5556
ALPHAIIO	First parameter of Iii for IIMOD=2	m/V	0
ALPHAIIO1	Temperature dependence of ALPHAIIO	—	0
ALPHAI11	L scaling parameter of Iii for IIMOD=2	V ⁻¹	0
ALPHAI111	Temperature dependence of ALPHAI11	—	0
AMEXP	Pre-exponential coefficient for MEXP	—	0
AMEXPR	Pre-exponential coefficient for MEXPR	—	0
APCLM	Pre-exponential coefficient for PCLM	—	0
APCLMR	Reverse-mode pre-exponential coefficient for PCLM	—	0
APSAT	Pre-exponential coefficient for PSAT	—	0
APSATCV	Pre-exponential coefficient for PSATCV	—	0
APTWG	Pre-exponential coefficient for PTWG	—	0
AQMTCEM	Parameter for geometric dependence of Tcen on R/TFIN/HFIN	—	0
ARDSW	Pre-exponential coefficient for RDSW	—	0
ARDW	Pre-exponential coefficient for RDW	—	0
ARSDEND	Extra raised source/drain cross sectional area at the two ends of the FinFET	m ²	0
ARSW	Pre-exponential coefficient for RSW	—	0
ASEJ	Source junction area (BULKMOD=1 or 2)	m ²	0
ASEO	Source-to-substrate overlap area through oxide	m ²	0
ASHEXP	Exponent to tune RTH dependence of NFINTOTAL	—	1
ASILIEND	Extra silicide cross sectional area at the two ends of the FinFET	m ²	0
ASYMMOD	0: Turn off asymmetry model - forward mode parameters used; 1: Turn on asymmetry model	—	0
AT	Saturation velocity temperature coefficient	—	-0.00156
ATCV	Saturation velocity temperature coefficient for CV	—	0
ATR	Reverse-mode saturation velocity temperature coefficient	—	0
AUA	Pre-exponential coefficient for UA	—	0
AUAR	Reverse-mode pre-exponential coefficient for UA	—	0
AUD	Pre-exponential coefficient for UD	—	0
AUDR	Reverse-mode pre-exponential coefficient for UD	—	0
AVSAT	Pre-exponential coefficient for VSAT	—	0
AVSAT1	Pre-exponential coefficient for VSAT1	—	0
AVSATCV	Pre-exponential coefficient for VSATCV	—	0

Table 2-130. BSIM-CMG FINFET v110.0.0 Device Model Parameters

Parameter	Description	Units	Default
BDVTP0	Exponential coefficient for DITS	—	1e-07
BDVTP1	Exponential coefficient for DVTP1	—	1e-07
BETA0	Vds dependence parameter of Iii	V ⁻¹	0
BETAI0	Vds dependence parameter of Iii	V ⁻¹	0
BETAI1	Vds dependence parameter of Iii	—	0
BETAI2	Vds dependence parameter of Iii	V	0.1
BEU	Exponential coefficient for EU	—	1e-07
BEUR	Reverse-mode exponential coefficient for EU	—	0
BG0SUB	Bandgap of substrate at 300.15K	—	1.12
BGIDL	Exponential coefficient for GIDL	—	0
BGISL	Exponential coefficient for GISL	—	3e+08
BIGBACC	Parameter for Igb in accumulation	—	0.00171
BIGBINV	Parameter for Igb in inversion	—	0.000949
BIGC	Parameter for Igc in inversion	—	0.00171
BIGD	Parameter for Igd in inversion	—	0
BIGEN	Thermal generation current parameter	—	0
BIGS	Parameter for Igs in inversion	—	0.00171
BMEXP	Exponential coefficient for MEXP	—	1
BMEXPR	Exponential coefficient for MEXPR	—	0
BPCLM	Exponential coefficient for PCLM	—	1e-07
BPCLMR	Reverse-mode exponential coefficient for PCLM	—	0
BPSAT	Exponential coefficient for PSAT	—	1
BPSATCV	Exponential coefficient for PSATCV	—	0
BPTWG	Exponential coefficient for PTWG	—	1e-07
BQMTCEN	Parameter for geometric dependence of Tcen on R/TFIN/HFIN	—	1.2e-08
BRDSW	exponential coefficient for RDSW	—	1e-07
BRDW	Exponential coefficient for RDW	—	1e-07
BRSW	Exponential coefficient for RSW	—	1e-07
BSHEXP	Exponent to tune RTH dependence of NF	—	1
BUA	Exponential coefficient for UA	—	1e-07
BUAR	Reverse-mode exponential coefficient for UAR	—	0
BUD	Exponential coefficient for UD	—	5e-08
BUDR	Reverse-mode exponential coefficient for UD	—	0
BULKMOD	0: SOI multi-gate; 1: Bulk multi-gate; 2: for decoupled bulk multi-gate	—	0

Table 2-130. BSIM-CMG FINFET v110.0.0 Device Model Parameters

Parameter	Description	Units	Default
BVD	Drain diode breakdown voltage	V	0
BVS	Source diode breakdown voltage	V	10
BVSAT	Exponential coefficient for VSAT	—	1e-07
BVSAT1	Exponential coefficient for VSAT1	—	0
BVSATCV	Exponential coefficient for VSATCV	—	0
CDSC	Coupling capacitance between S/D and channel	—	0.007
CDSCD	Drain-bias sensitivity of CDSC	—	0.007
CDSCDN1	NFIN dependence of CDSCD	—	0
CDSCDN2	NFIN dependence of CDSCD	—	100000
CDSCDR	Reverse-mode drain-bias sensitivity of CDSC	—	0
CDSCDRN1	NFIN dependence of CDSCD	—	0
CDSCDRN2	NFIN dependence of CDSCD	—	0
CDSCN1	NFIN dependence of CDSC	—	0
CDSCN2	NFIN dependence of CDSC	—	100000
CDSP	Constant drain-to-source fringe capacitance (all CGEOMOD)	F	0
CFD	Outer fringe capacitance at drain side	—	0
CFS	Outer fringe capacitance at source side	—	2.5e-11
CGBL	Bias dependent component of gate-to-substrate overlap capacitance per unit channel length per fin per finger	—	0
CGBN	Gate-to-substrate overlap capacitance per unit channel length per fin per finger	—	0
CGBO	Gate-to-substrate overlap capacitance per unit channel length per finger per NGCON	—	0
CGDL	Overlap capacitance between gate and lightly-doped drain region (for CGEOMOD = 0, 2)	—	0
CGDO	Non LDD region drain-gate overlap capacitance per unit channel width	—	0
CGDP	Constant gate-to-drain fringe capacitance (CGEOMOD=1)	—	0
CGEO1SW	For CGEOMOD=1 only, this switch enables the parameters COVS, COVD, CGSP, and CGDP to be in F per fin, per gate-finger, per unit channel width	—	0
CGEOA	Fitting parameter for CGEOMOD=2	—	1
CGEOB	Fitting parameter for CGEOMOD=2	—	0
CGEOC	Fitting parameter for CGEOMOD=2	—	0
CGEOD	Fitting parameter for CGEOMOD=2	—	0
CGEOE	Fitting parameter for CGEOMOD=2	—	1

Table 2-130. BSIM-CMG FINFET v110.0.0 Device Model Parameters

Parameter	Description	Units	Default
CGEOMOD	Geometry-dependent parasitic capacitance model selector	—	0
CGIDL	Parameter for body-effect of GIDL	—	0
CGISL	Parameter for body-effect of GISL	—	0.5
CGSL	Overlap capacitance between gate and lightly-doped source region (for CGEOMOD = 0, 2)	—	0
CGSO	Non LDD region source-gate overlap capacitance per unit channel width	—	0
CGSP	Constant gate-to-source fringe capacitance (CGEOMOD=1)	—	0
CHARGEWF	Average channel charge weighting factor, +1: source-side, 0: middle, -1: drain-side	—	0
CIGBACC	Parameter for Igb in accumulation	V ⁻¹	0.075
CIGBINV	Parameter for Igb in inversion	V ⁻¹	0.006
CIGC	Parameter for Igc in inversion	V ⁻¹	0.075
CIGD	Parameter for Igd in inversion	V ⁻¹	0
CIGS	Parameter for Igs in inversion	V ⁻¹	0.075
CINS_UFCM	Insulator capacitance for the unified Model	—	1
CIT	Parameter for interface trap	—	0
CITR	Parameter for interface trap in reverse mode for asymmetric model	—	0
CJD	Unit area drain-side junction capacitance at zero bias	—	0
CJS	Unit area source-side junction capacitance at zero bias	—	0.0005
CJSWD	Unit length drain-side sidewall junction capacitance at zero bias	—	0
CJSWGD	Unit length drain-side gate sidewall junction capacitance at zero bias	—	0
CJSWGS	Unit length source-side gate sidewall junction capacitance at zero bias	—	0
CJSWS	Unit length source-side sidewall junction capacitance at zero bias	—	5e-10
CKAPPAB	Bias dependent gate-to-substrate parasitic capacitance	—	0.6
CKAPPAD	Coefficient of bias-dependent overlap capacitance for the drain side (for CGEOMOD = 0, 2)	V	0
CKAPPAS	Coefficient of bias-dependent overlap capacitance for the source side (for CGEOMOD = 0, 2)	V	0.6
COVD	Constant gate-to-drain overlap capacitance (CGEOMOD=1)	—	0
COVS	Constant gate-to-source overlap capacitance (CGEOMOD=1)	—	0

Table 2-130. BSIM-CMG FINFET v110.0.0 Device Model Parameters

Parameter	Description	Units	Default
CRATIO	Ratio of the corner area filled with silicon to the total corner area	—	0.5
CSDESW	Coefficient for source/drain-to-substrate sidewall capacitance	—	0
CTH0	Thermal capacitance	—	1e-05
D	Diameter of the cylinder (GEOMOD=3)	m	4e-08
DELTAPRSD	Change in silicon/silicide interface length due to non-rectangular epi	m	0
DELTAVSAT	velocity saturation parameter in the linear region	—	1
DELTAVSATCV	Velocity saturation parameter in the linear region for the capacitance model	—	0
DELTAW	Change of effective width due to shape of fin/cylinder	m	0
DELTAWCV	CV change of effective width due to shape of fin/cylinder	m	0
DELVFBACC	Change in flatband voltage: Vfb_accumulation - Vfb_inversion	V	0
DELVTRAND	Variability in Vth	V	0
DEVTYPE	0: PMOS; 1: NMOS	—	1
DLBIN	Delta L for binning	m	0
DLC	Delta L for C-V model	m	0
DLCACC	Delta L for C-V model in accumulation region (BULKMOD=1 or 2)	m	0
DLCIGD	Delta L for Igd model	m	0
DLCIGS	Delta L for Igs model	m	0
DROUT	L dependence of DIBL effect on Rout	—	1.06
DSUB	DIBL exponent coefficient	—	1.06
DTEMP	Variability in device temperature	°C	0
DVT0	SCE coefficient	—	0
DVT1	SCE exponent coefficient. After binning it should be within (0:inf)	—	0.6
DVT1SS	Subthreshold swing exponent coefficient. After binning it should be within (0:inf)	—	0
DVTP0	Coefficient for drain-induced Vth shift (DITS)	—	0
DVTP1	DITS exponent coefficient	—	0
DVTP2	DITS model parameter	—	0
DVTSHIFT	Vth shift handle	V	0
DVTSHIFTR	Vth shift handle for asymmetric mode	—	0
EASUB	Electron affinity of substrate	—	4.05

Table 2-130. BSIM-CMG FINFET v110.0.0 Device Model Parameters

Parameter	Description	Units	Default
EF	Flicker noise frequency exponent	—	1
EGIDL	Band bending parameter for GIDL	V	0
EGISL	Band bending parameter for GISL	V	0.2
EIGBINV	Parameter for Igb in inversion	V	1.1
EM	Flicker noise parameter	—	4.1e+07
EMOBT	Temperature coefficient of ETAMOB	—	0
EOT	Equivalent oxide thickness	m	1e-09
EOTACC	Equivalent oxide thickness for accumulation region	m	0
EOTBOX	Equivalent oxide thickness of the buried oxide (SOI FinFET)	m	1.4e-07
EPSROX	Relative dielectric constant of the gate dielectric	—	3.9
EPSRSP	Relative dielectric constant of the spacer	—	3.9
EPSRSUB	Relative dielectric constant of the channel material	—	11.9
ESATII	Saturation channel E-field for Iii	—	1e+07
ETA0	DIBL coefficient	—	0.6
ETA0LT	Coupled NFIN and length dependence of ETA0	—	0
ETA0N1	NFIN dependence of ETA0	—	0
ETA0N2	NFIN dependence of ETA0	—	100000
ETA0R	Reverse-mode DIBL coefficient	—	0
ETAMOB	Effective field parameter	—	2
ETAQM	Bulk charge coefficient for Tcen	—	0.54
EU	Phonon/surface roughness scattering parameter	—	2.5
EUR	Reverse-mode phonon/surface roughness scattering parameter	—	0
FECH	End-channel factor for different orientation/shape	—	1
FECHCV	CV end-channel factor for different orientation/shape	—	1
FPITCH	Fin pitch	m	8e-08
GEOMOD	0: Double gate; 1: Triple gate; 2: Quadruple gate; 3: Cylindrical gate; 4: Unified fin Shape	—	0
GIDLMOD	0: Turn off GIDL/GISL current; 1: Turn on GIDL/GISL current	—	0
HEPI	Height of the raised source/drain on top of the fin	m	1e-08
HFIN	Fin height	m	3e-08
IDS0MULT	Variability in drain current for miscellaneous reasons	—	1
IGBMOD	0: Turn off Igb; 1: Turn on Igb	—	0
IGCLAMP	0: Disable gate current clamps; 1: Enable gate current clamps	—	1

Table 2-130. BSIM-CMG FINFET v110.0.0 Device Model Parameters

Parameter	Description	Units	Default
IGCMOD	0: Turn off Igc, Igs and Igd; 1: Turn on Igc, Igs and Igd	—	0
IGT	Gate current temperature dependence	—	2.5
IIMOD	0: Turn off impact ionization current; 1: BSIM4-based model; 2: BSIMSOI-based model	—	0
IIMOD2CLAMP1	Clamp1 of SII1*Vg term in IIMOD=2 model	V	0.1
IIMOD2CLAMP2	Clamp2 of SII0*Vg term in IIMOD=2 model	V	0.1
IIMOD2CLAMP3	Clamp3 of Ratio term in IIMOD=2 model	V	0.1
IIT	Impact ionization temperature dependence for IIMOD = 1	—	-0.5
IJTHDFWD	Forward drain diode breakdown limiting current	A	0
IJTHDREV	Reverse drain diode breakdown limiting current	A	0
IJTHSFWD	Forward source diode breakdown limiting current	A	0.1
IJTHSREV	Reverse source diode breakdown limiting current	A	0.1
IMIN	Parameter for Vgs clamping for inversion region calculation in accumulation	—	1e-15
JSD	Bottom drain junction reverse saturation current density	—	0
JSS	Bottom source junction reverse saturation current density	—	0.0001
JSWD	Unit length reverse saturation current for sidewall drain junction	—	0
JSWGD	Unit length reverse saturation current for gate-edge sidewall drain junction	—	0
JSWGS	Unit length reverse saturation current for gate-edge sidewall source junction	—	0
JSWS	Unit length reverse saturation current for sidewall source junction	—	0
JTSD	Bottom drain junction trap-assisted saturation current density	—	0
JTSS	Bottom source junction trap-assisted saturation current density	—	0
JTSSWD	Unit length trap-assisted saturation current for sidewall drain junction	—	0
JTSSWGD	Unit length trap-assisted saturation current for gate-edge sidewall drain junction	—	0
JTSSWGS	Unit length trap-assisted saturation current for gate-edge sidewall source junction	—	0
JTSSWS	Unit length trap-assisted saturation current for sidewall source junction	—	0
JTWEFF	Trap-assisted tunneling current width dependence	m	0

Table 2-130. BSIM-CMG FINFET v110.0.0 Device Model Parameters

Parameter	Description	Units	Default
K0	Lateral NUD voltage parameter	V	0
K01	Temperature dependence of lateral NUD voltage parameter	V/K	0
K0SI	Correction factor for strong inversion used in Mnud. After binning it should be within (0:inf)	—	1
K0SI1	Temperature dependence of K0SI	—	0
K0SISAT	Correction factor for strong inversion used in Mnud	—	0
K0SISAT1	Temperature dependence of K0SISAT	—	0
K1	Body effect coefficient for subthreshold region	—	1e-06
K11	Temperature dependence of K1	—	0
K1RSCE	K1 for reverse short channel effect calculation	—	0
K2	Body effect coefficient for BULKMOD==2	—	0
K21	Temperature dependence of K2	—	0
K2SAT	Correction factor for K2 in saturation (high Vds)	—	0
K2SAT1	Temperature dependence of K2SAT	—	0
K2SI	Correction factor for strong inversion used in Mob	—	0
K2SI1	Temperature dependence of K2SI	—	0
K2SISAT	Correction factor for strong inversion used in Mob	—	0
K2SISAT1	Temperature dependence of K2SISAT	—	0
KSATIV	Parameter for long channel Vdsat	—	1
KSATIVR	KSATIV in asymmetric mode	—	0
KT1	Vth temperature coefficient	V	0
KT1L	Vth temperature L coefficient	—	0
L	Designed gate length	m	3e-08
LA1		—	0
LA11		—	0
LA2		—	0
LA21		—	0
LAGIDL		—	0
LAGISL		—	0
LAIGBACC		—	0
LAIGBACC1		—	0
LAIGBINV		—	0
LAIGBINV1		—	0
LAIGC		—	0
LAIGC1		—	0

Table 2-130. BSIM-CMG FINFET v110.0.0 Device Model Parameters

Parameter	Description	Units	Default
LAIGD		—	0
LAIGD1		—	0
LAIGEN		—	0
LAIGS		—	0
LAIGS1		—	0
LALPHA0		—	0
LALPHA1		m/V	0
LALPHAI0		—	0
LALPHAI1		m/V	0
LAT		—	0
LATCV		—	0
LATR		—	0
LBETA0		m/V	0
LBETAI0		m/V	0
LBETAI1		—	0
LBETAI2		—	0
LBGIDL		V	0
LBGISL		V	0
LBIGBACC		—	0
LBIGBINV		—	0
LBIGC		—	0
LBIGD		—	0
LBIGEN		—	0
LBIGS		—	0
LCDSC		—	0
LCDSCD		—	0
LCDSCLR		—	0
LCFD		F	0
LCFS		F	0
LCGBL		F	0
LCGDL		F	0
LCGIDL		—	0
LCGISL		—	0
LCGSL		F	0
LCIGBACC		m/V	0
LCIGBINV		m/V	0

Table 2-130. BSIM-CMG FINFET v110.0.0 Device Model Parameters

Parameter	Description	Units	Default
LCIGC		m/V	0
LCIGD		m/V	0
LCIGS		m/V	0
LCIT		—	0
LCITR		—	0
LCKAPPAB		—	0
LCKAPPAD		—	0
LCKAPPAS		—	0
LCOVD		F	0
LCOVS		F	0
LDELTAVSAT		—	0
LDELTAVSATCV		—	0
LDROUT		—	0
LDSUB		—	0
LDVT0		—	0
LDVT1		—	0
LDVT1SS		—	0
LDVTB		—	0
LDVTSHIFT		—	0
LDVTSHIFTR		—	0
LEGIDL		—	0
LEGISL		—	0
LEIGBINV		—	0
LEMOBT		—	0
LESATII		V	0
LETA0		—	0
LETA0R		—	0
LETAMOB		—	0
LEU		—	0
LEUR		—	0
LIGT		—	0
LII	Channel length dependence parameter of I_{ii}	—	5e-10
LIIT		—	0
LINT	Length reduction parameter (dopant diffusion effect)	m	0
LINTIGEN	Lint for thermal generation current	m	0
LINTNOI	L offset for flicker noise calculation	m ²	0

Table 2-130. BSIM-CMG FINFET v110.0.0 Device Model Parameters

Parameter	Description	Units	Default
LK0		—	0
LK01		—	0
LK0SI		—	0
LK0SI1		—	0
LK0SISAT		—	0
LK0SISAT1		—	0
LK1		—	0
LK11		—	0
LK1RSCE		—	0
LK2		—	0
LK21		—	0
LK2SAT		—	0
LK2SAT1		—	0
LK2SI		—	0
LK2SI1		—	0
LK2SISAT		—	0
LK2SISAT1		—	0
LKSATIV		—	0
LKSATIVR		—	0
LKT1		—	0
LL	Length reduction parameter (dopant diffusion effect)	—	0
LLC	Length reduction parameter (dopant diffusion effect)	—	0
LLII		—	0
LLN	Length reduction parameter (dopant diffusion effect)	—	1
LLPE0		m ²	0
LLPEB		—	0
LMEXP		—	0
LMEXPR		—	0
LNBODY		—	0
LNGATE		—	0
LNIGBACC		—	0
LNIGBINV		—	0
LNTGEN		—	0
LNTOX		—	0
LPA	Mobility L power coefficient	—	1
LPAR	Reverse-mode mobility L power coefficient	—	0

Table 2-130. BSIM-CMG FINFET v110.0.0 Device Model Parameters

Parameter	Description	Units	Default
LPCLM		—	0
LPCLMCV		—	0
LPCLMG		—	0
LPCLMR		—	0
LPDIBL1		—	0
LPDIBL1R		—	0
LPDIBL2		—	0
LPDIBL2R		—	0
LPE0	Equivalent length of pocket region at zero bias	m	5e-09
LPGIDL		—	0
LPGISL		—	0
LPHIBE		—	0
LPHIG		—	0
LPHIN		—	0
LPIGCD		—	0
LPOXEDGE		—	0
LPRT		—	0
LPRWGD		m/V	0
LPRWGS		m/V	0
LPSAT		—	0
LPSATCV		—	0
LPTWG		—	0
LPTWGR		—	0
LPTWGT		—	0
LPVAG		—	0
LQMFACOR		—	0
LQMCENCV		—	0
LQMCENCVA		—	0
LRDSW		—	0
LRDW		—	0
LRSD	Length of the source/drain	m	0
LRSW		—	0
LSII0		m/V	0
LSII1		—	0
LSII2		—	0
LSIID		—	0

Table 2-130. BSIM-CMG FINFET v110.0.0 Device Model Parameters

Parameter	Description	Units	Default
LSP	Thickness of the gate sidewall spacer	m	0
LSTHETASAT		—	0
LTGIDL		—	0
LTII		—	0
LTSS		—	0
LU0		—	0
LU0R		—	0
LUA		—	0
LUA1		—	0
LUA1R		—	0
LUAR		—	0
LUC		—	0
LUC1		—	0
LUC1R		—	0
LUCR		—	0
LUCS		—	0
LUCSTE		—	0
LUD		—	0
LUD1		—	0
LUD1R		—	0
LUDR		—	0
LUP		—	0
LUPR		—	0
LUTE		—	0
LUTER		—	0
LUTL		—	0
LUTLR		—	0
LVSAT		—	0
LVSAT1		—	0
LVSAT1R		—	0
LVSATCV		—	0
LVSATR		—	0
LWR		—	0
LXRRCG1		—	0
LXRRCG2		—	0
MEXP	Smoothing function factor for Vdsat	—	4

Table 2-130. BSIM-CMG FINFET v110.0.0 Device Model Parameters

Parameter	Description	Units	Default
MEXPR	Reverse-mode smoothing function factor for Vdsat	—	0
MJD	Drain bottom junction capacitance grading coefficient	—	0
MJD2	Drain bottom two-step second junction capacitance grading coefficient	—	0
MJS	Source bottom junction capacitance grading coefficient	—	0.5
MJS2	Source bottom two-step second junction capacitance grading coefficient	—	0.125
MJSWD	Drain sidewall junction capacitance grading coefficient	—	0
MJSWD2	Drain sidewall two-step second junction capacitance grading coefficient	—	0
MJSWGD	Drain-side gate sidewall junction capacitance grading coefficient	—	0
MJSWGD2	Drain-side gate sidewall two-step second junction capacitance grading coefficient	—	0
MJSWGS	Source-side gate sidewall junction capacitance grading coefficient	—	0
MJSWGS2	Source-side gate sidewall two-step second junction capacitance grading coefficient	—	0
MJSWS	Source sidewall junction capacitance grading coefficient	—	0.33
MJSWS2	Source sidewall two-step second junction capacitance grading coefficient	—	0.083
NA1		—	0
NA11		—	0
NA2		—	0
NA21		—	0
NAGIDL		—	0
NAGISL		—	0
NAIGBACC		—	0
NAIGBACC1		—	0
NAIGBINV		—	0
NAIGBINV1		—	0
NAIGC		—	0
NAIGC1		—	0
NAIGD		—	0
NAIGD1		—	0
NAIGEN		—	0

Table 2-130. BSIM-CMG FINFET v110.0.0 Device Model Parameters

Parameter	Description	Units	Default
NAIGS		—	0
NAIGS1		—	0
NALPHA0		—	0
NALPHA1		m/V	0
NALPHAI0		—	0
NALPHAI1		m/V	0
NAT		—	0
NATCV		—	0
NATR		—	0
NBETA0		m/V	0
NBETAI0		m/V	0
NBETAI1		—	0
NBETAI2		—	0
NBGIDL		V	0
NBGISL		V	0
NBIGBACC		—	0
NBIGBINV		—	0
NBIGC		—	0
NBIGD		—	0
NBIGEN		—	0
NBIGS		—	0
NBODY	Channel (body) doping	—	1e+22
NBODYN1	NFIN dependence of channel (body) doping	—	0
NBODYN2	NFIN dependence of channel (body) doping	—	100000
NC0SUB	Conduction band density of states	—	2.86e+25
NCDS		—	0
NCDS		—	0
NCDS		—	0
NCDF		F	0
NCFS		F	0
NCGBL		F	0
NCGDL		F	0
NCGIDL		—	0
NCGISL		—	0
NCGSL		F	0
NCIGBACC		m/V	0

Table 2-130. BSIM-CMG FINFET v110.0.0 Device Model Parameters

Parameter	Description	Units	Default
NCIGBINV		m/V	0
NCIGC		m/V	0
NCIGD		m/V	0
NCIGS		m/V	0
NCIT		—	0
NCITR		—	0
NCKAPPAB		—	0
NCKAPPAD		—	0
NCKAPPAS		—	0
NCOVD		F	0
NCOVS		F	0
NDELTAVSAT		—	0
NDELTAVSATCV		—	0
NDROUT		—	0
NDSUB		—	0
NDVT0		—	0
NDVT1		—	0
NDVT1SS		—	0
NDVTB		—	0
NDVTSHIFT		—	0
NDVTSHIFTR		—	0
NEGIDL		—	0
NEGISL		—	0
NEIGBINV		—	0
NEMOBT		—	0
NESATII		V	0
NETA0		—	0
NETA0R		—	0
NETAMOB		—	0
NEU		—	0
NEUR		—	0
NF	Number of fingers	—	1
NFIN	Number of fins per finger (real number enables optimization)	—	1
NGATE	Parameter for poly gate doping. For metal gate please set NGATE = 0	—	0

Table 2-130. BSIM-CMG FINFET v110.0.0 Device Model Parameters

Parameter	Description	Units	Default
NGCON	Number of gate contact (1 or 2 sided)	—	1
NI0SUB	Intrinsic carrier constant at 300.15K	—	1.1e+16
NIGBACC	Parameter for Igb in accumulation	—	1
NIGBINV	Parameter for Igb in inversion	—	3
NIGT		—	0
NIIT		—	0
NJD	Drain junction emission coefficient	—	0
NJS	Source junction emission coefficient	—	1
NJTS	Non-ideality factor for JTSS	—	20
NJTSD	Non-ideality factor for JTSD	—	0
NJTSSW	Non-ideality factor for JTSSWS	—	20
NJTSSWD	Non-ideality factor for JTSSWD	—	0
NJTSSWG	Non-ideality factor for JTSSWGS	—	20
NJTSSWGD	Non-ideality factor for JTSSWGD	—	0
NK0		—	0
NK01		—	0
NK0SI		—	0
NK0SI1		—	0
NK0SISAT		—	0
NK0SISAT1		—	0
NK1		—	0
NK11		—	0
NK1RSCE		—	0
NK2		—	0
NK21		—	0
NK2SAT		—	0
NK2SAT1		—	0
NK2SI		—	0
NK2SI1		—	0
NK2SISAT		—	0
NK2SISAT1		—	0
NKSATIV		—	0
NKSATIVR		—	0
NKT1		—	0
NLII		—	0
NLPE0		m ²	0

Table 2-130. BSIM-CMG FINFET v110.0.0 Device Model Parameters

Parameter	Description	Units	Default
NLPEB		—	0
NMEXP		—	0
NMEXPR		—	0
NNBODY		—	0
NNGATE		—	0
NNIGBACC		—	0
NNIGBINV		—	0
NNTGEN		—	0
NNTOX		—	0
NOIA	Flicker noise parameter	—	6.25e+39
NOIB	Flicker noise parameter	—	3.125e+24
NOIC	Flicker noise parameter	—	8.75e+07
NPCLM		—	0
NPCLMCV		—	0
NPCLMG		—	0
NPCLMR		—	0
NPDI1BL1		—	0
NPDI1BL1R		—	0
NPDI1BL2		—	0
NPDI1BL2R		—	0
NPIDL		—	0
NPISL		—	0
NPHIBE		—	0
NPHIG		—	0
NPHIN		—	0
NPIGCD		—	0
NPOXEDGE		—	0
NPRT		—	0
NPRWGD		m/V	0
NPRWGS		m/V	0
NPSAT		—	0
NPSATCV		—	0
NPTWG		—	0
NPTWGR		—	0
NPTWGT		—	0
NPVAG		—	0

Table 2-130. BSIM-CMG FINFET v110.0.0 Device Model Parameters

Parameter	Description	Units	Default
NQMFACTOR		—	0
NQMTCECV		—	0
NQMTCECVA		—	0
NQSMOD	0: Turn off NQS model; 1: NQS gate resistance (with gi node); 2: NQS charge deficit model from BSIM4 (with q node)	—	0
NRD	Number of source diffusion squares	—	0
NRDSW		—	0
NRDW		—	0
NRS	Number of source diffusion squares	—	0
NRSW		—	0
NSD	Source/drain active doping concentration	—	2e+26
NSDE	Source/drain active doping concentration at Leff edge	—	2e+25
NSEG	Number of segments for NQSMOD=3 (3, 5 and 10 supported)	—	4
NSII0		m/V	0
NSII1		—	0
NSII2		—	0
NSIID		—	0
NSTHETASAT		—	0
NTGEN	Thermal generation current parameter	—	1
NTGIDL		—	0
NTII		—	0
NTNOI	Thermal noise parameter	—	1
NTOX	Exponent for Tox ratio	—	1
NTSS		—	0
NU0		—	0
NU0R		—	0
NUA		—	0
NUA1		—	0
NUA1R		—	0
NUAR		—	0
NUC		—	0
NUC1		—	0
NUC1R		—	0
NUCR		—	0
NUCS		—	0

Table 2-130. BSIM-CMG FINFET v110.0.0 Device Model Parameters

Parameter	Description	Units	Default
NUCSTE		—	0
NUD		—	0
NUD1		—	0
NUD1R		—	0
NUDR		—	0
NUP		—	0
NUPR		—	0
NUTE		—	0
NUTER		—	0
NUTL		—	0
NUTLR		—	0
NVSAT		—	0
NVSAT1		—	0
NVSAT1R		—	0
NVSATCV		—	0
NVSATR		—	0
NVTM	Subthreshold swing factor multiplied by V_{tm} . If defined by user, it will overwrite nV_{tm} in the code	V	0
NWR		—	0
NXRCRG1		—	0
NXRCRG2		—	0
PA1		—	0
PA11		—	0
PA2		—	0
PA21		—	0
PAGIDL		—	0
PAGISL		—	0
PAIGBACC		—	0
PAIGBACC1		—	0
PAIGBINV		—	0
PAIGBINV1		—	0
PAIGC		—	0
PAIGC1		—	0
PAIGD		—	0
PAIGD1		—	0
PAIGEN		—	0

Table 2-130. BSIM-CMG FINFET v110.0.0 Device Model Parameters

Parameter	Description	Units	Default
PAIGS		—	0
PAIGS1		—	0
PALPHA0		—	0
PALPHA1		—	0
PALPHAIIO		—	0
PALPHAIIO1		—	0
PAT		—	0
PATCV		—	0
PATR		—	0
PBD	Drain-side bulk junction built-in potential	V	0
PBETA0		—	0
PBETAIIO		—	0
PBETAIIO1		—	0
PBETAIIO2		—	0
PBGIDL		—	0
PBGISL		—	0
PBIGBACC		—	0
PBIGBINV		—	0
PBIGC		—	0
PBIGD		—	0
PBIGEN		—	0
PBIGS		—	0
PBS	Source-side bulk junction built-in potential	V	1
PBSWD	Built-in potential for Drain-side sidewall junction capacitance	V	0
PBSWGD	Built-in potential for Drain-side gate sidewall junction capacitance	V	0
PBSWGS	Built-in potential for Source-side gate sidewall junction capacitance	V	0
PBSWS	Built-in potential for Source-side sidewall junction capacitance	V	1
PCDSC		F	0
PCDSCD		F	0
PCDSCDR		F	0
PCFD		—	0
PCFS		—	0
PCGBL		—	0

Table 2-130. BSIM-CMG FINFET v110.0.0 Device Model Parameters

Parameter	Description	Units	Default
PCGDL		—	0
PCGIDL		—	0
PCGISL		—	0
PCGSL		—	0
PCIGBACC		—	0
PCIGBINV		—	0
PCIGC		—	0
PCIGD		—	0
PCIGS		—	0
PCIT		F	0
PCITR		—	0
PCKAPPAB		—	0
PCKAPPAD		—	0
PCKAPPAS		—	0
PCLM	Channel length modulation (CLM) parameter	—	0.013
PCLMCV	CLM parameter for short-channel CV	—	0
PCLMG	Gate bias dependence parameter for CLM	—	0
PCLMR	Reverse model PCLM parameter	—	0
PCOVD		—	0
PCOVS		—	0
PDEJ	Drain-to-substrate PN junction perimeter (BULKMOD=1 or 2)	m	0
PDELTAVSAT		—	0
PDELTAVSATCV		—	0
PDEO	Perimeter of drain-to-substrate overlap region through oxide	m	0
PDIBL1	DIBL output conductance parameter - forward mode	—	1.3
PDIBL1R	DIBL output conductance parameter - reverse mode	—	0
PDIBL2	DIBL output conductance parameter	—	0.0002
PDIBL2R	DIBL output conductance parameter - reverse mode	—	0
PDROUT		—	0
PDSUB		—	0
PDVT0		—	0
PDVT1		—	0
PDVT1SS		—	0
PDVTB		—	0

Table 2-130. BSIM-CMG FINFET v110.0.0 Device Model Parameters

Parameter	Description	Units	Default
PDVTSHIFT		—	0
PDVTSHIFTR		—	0
PEGIDL		—	0
PEGISL		—	0
PEIGBINV		—	0
PEMOBT		—	0
PESATII		—	0
PETA0		—	0
PETA0R		—	0
PETAMOB		—	0
PEU		—	0
PEUR		—	0
PGIDL	Parameter for body-bias effect on GIDL	—	0
PGISL	Parameter for body-bias effect on GISL	—	1
PHIBE	Body effect voltage parameter. After binning it should be within [0.2:1.2]	V	0.7
PHIG	Gate workfunction	—	4.61
PHIGL	Length dependence of gate workfunction	—	0
PHIGLT	Coupled NFIN and length dependence of gate workfunction	—	0
PHIGN1	NFIN dependence of gate workfunction	—	0
PHIGN2	NFIN dependence of gate workfunction	—	100000
PHIN	Nonuniform vertical doping effect on surface potential	V	0.05
PIGCD	Parameter for Igc partition	—	1
PIGT		—	0
PIIT		—	0
PK0		—	0
PK01		—	0
PK0SI		—	0
PK0SI1		—	0
PK0SISAT		—	0
PK0SISAT1		—	0
PK1		—	0
PK11		—	0
PK1RSCE		—	0
PK2		—	0

Table 2-130. BSIM-CMG FINFET v110.0.0 Device Model Parameters

Parameter	Description	Units	Default
PK21		—	0
PK2SAT		—	0
PK2SAT1		—	0
PK2SI		—	0
PK2SI1		—	0
PK2SISAT		—	0
PK2SISAT1		—	0
PKSATIV		—	0
PKSATIVR		—	0
PKT1		—	0
PLII		—	0
PLPE0		—	0
PLPEB		—	0
PMEXP		—	0
PMEXPR		—	0
PNBODY		—	0
PNGATE		—	0
PNIGBACC		—	0
PNIGBINV		—	0
PNTGEN		—	0
PNTOX		—	0
POXEDGE	Factor for the gate edge Tox	—	1
PPCLM		—	0
PPCLMCV		—	0
PPCLMG		—	0
PPCLMR		—	0
PPDIBL1		—	0
PPDIBL1R		—	0
PPDIBL2		—	0
PPDIBL2R		—	0
PPGIDL		—	0
PPGISL		—	0
PPHIBE		—	0
PPHIG		—	0
PPHIN		—	0
PPIGCD		—	0

Table 2-130. BSIM-CMG FINFET v110.0.0 Device Model Parameters

Parameter	Description	Units	Default
PPOXEDGE		—	0
PPRT		—	0
PPRWGD		—	0
PPRWGS		—	0
PPSAT		—	0
PPSATCV		—	0
PPTWG		—	0
PPTWGR		—	0
PPTWGT		—	0
PPVAG		—	0
PQM	Slope of normalized Tcen in inversion	—	0.66
PQMACC	Slope of normalized Tcen in accumulation	—	0.66
PQMFACTOR		—	0
PQMTCENCV		—	0
PQMTCENCVA		—	0
PRDDR	Drain-side quasi-saturation parameter	—	0
PRDSW		—	0
PRDW		—	0
PRSDEND	Extra silicon/silicide interface perimeter at the two ends of the FinFET	m	0
PRSDR	Source-side quasi-saturation parameter	—	1
PRSW		—	0
PRT	Series resistance temperature coefficient	—	0.001
PRWGD	Gate bias dependence of drain extension resistance	V ⁻¹	0
PRWGS	Gate bias dependence of source extension resistance	V ⁻¹	0
PSAT	Velocity saturation exponent, after binnig should be from [2.0:inf)	—	2
PSATCV	Velocity saturation exponent for C-V	—	0
PSEJ	Source-to-substrate PN junction perimeter (BULKMOD=1 or 2)	m	0
PSEO	Perimeter of source-to-substrate overlap region through oxide	m	0
PSII0		—	0
PSII1		—	0
PSII2		—	0
PSIID		—	0
PSTTHETASAT		—	0

Table 2-130. BSIM-CMG FINFET v110.0.0 Device Model Parameters

Parameter	Description	Units	Default
PTGIDL		—	0
PTII		—	0
PTSS		—	0
PTWG	Gmsat degradation parameter - forward mode	—	0
PTWGR	Gmsat degradation parameter - reverse mode	—	0
PTWGT	PTWG temperature coefficient	—	0.004
PU0		—	0
PU0R		—	0
PUA		—	0
PUA1		—	0
PUA1R		—	0
PUAR		—	0
PUC		—	0
PUC1		—	0
PUC1R		—	0
PUCR		—	0
PUCS		—	0
PUCSTE		—	0
PUD		—	0
PUD1		—	0
PUD1R		—	0
PUDR		—	0
PUP		—	0
PUPR		—	0
PUTE		—	0
PUTER		—	0
PUTL		—	0
PUTLR		—	0
PVAG	Vgs dependence on early voltage	—	1
PVSAT		—	0
PVSAT1		—	0
PVSAT1R		—	0
PVSATCV		—	0
PVSATR		—	0
PWR		—	0
PXRCRG1		—	0

Table 2-130. BSIM-CMG FINFET v110.0.0 Device Model Parameters

Parameter	Description	Units	Default
PXRCRG2		—	0
QM0	Knee-point for Tcen in inversion (Charge normalized to Cox)	V	0.001
QM0ACC	Knee-point for Tcen in accumulation (Charge normalized to Cox)	V	0.001
QMFACTOR	Prefactor + switch for QM Vth correction	—	0
QMFACTORCV	Charge dependence taking QM effects into account	—	0
QMTCENCV	Prefactor + switch for QM Width and Toxeff correction for CV	—	0
QMTCENCVA	Prefactor + switch for QM Width and Toxeff correction for CV (accumulation region)	—	0
RDDR	Drain-side drift resistance parameter - forward mode	—	0
RDDRR	Drain-side drift resistance parameter - reverse mode	—	0
RDSMOD	0: Internal S/D resistance model; 1: External S/D resistance model; 2: Both bias dependent and independent part of S/D resistance internal	—	0
RDSW	RDSMOD = 0 zero bias S/D extension resistance per unit width	—	100
RDSWMIN	RDSMOD = 0 S/D extension resistance per unit width at high Vgs	—	0
RDW	RDSMOD = 1 zero bias drain extension resistance per unit width	—	50
RDWMIN	RDSMOD = 1 drain extension resistance per unit width at high Vgs	—	0
RGATEMOD	0: Turn off gate electrode resistance (without ge node); 1: Turn on gate electrode resistance (with ge node)	—	0
RGEOA	Fitting parameter for RGEOMOD=1	—	1
RGEOB	Fitting parameter for RGEOMOD=1	—	0
RGEOC	Fitting parameter for RGEOMOD=1	—	0
RGEOD	Fitting parameter for RGEOMOD=1	—	0
RGEOE	Fitting parameter for RGEOMOD=1	—	0
RGEOMOD	Geometry-dependent source/drain resistance; 0: RSH-based; 1: Holistic	—	0
RGEXT	Effective gate electrode external resistance	—	0
RGFIN	Effective gate electrode per finger per fin resistance	—	0.001
RHOC	Contact resistivity at the silicon/silicide interface	—	1e-12
RHORS	Average resistivity of silicon in the raised source/drain region	—	1
RNOIA	Thermal noise coefficient	—	0.577

Table 2-130. BSIM-CMG FINFET v110.0.0 Device Model Parameters

Parameter	Description	Units	Default
RNOIB	Thermal noise coefficient	—	0.37
RNOIC	Thermal noise coefficient for TNOIMOD=1	—	0.395
RSDR	Source-side drift resistance parameter - forward mode	—	0
RSDRR	Source-side drift resistance parameter - reverse mode	—	0
RSHD	Drain-side sheet resistance	—	0
RSHS	Source-side sheet resistance	—	0
RSW	RDSMOD = 1 zero bias source extension resistance per unit width	—	50
RSWMIN	RDSMOD = 1 source extension resistance per unit width at high Vgs	—	0
RTH0	Thermal resistance	—	0.01
SCALEN	Noise scaling parameter for TNOIMOD=1	—	100000
SDTERM	Indicator of whether the source/drain are terminated with silicide	—	0
SH_WARN	0: Disable self-heating warnings; 1: Enable self-heating warnings	—	0
SHMOD	0: Turn off self-heating; 1: Turn on self-heating	—	0
SII0	Vgs dependence parameter of Iii	V ⁻¹	0.5
SII1	1st Vgs dependence parameter of Iii	—	0.1
SII2	2nd Vgs dependence parameter of Iii	V	0
SIID	3rd Vds dependence parameter of Iii	V	0
SJD	Constant for drain-side two-step second junction	—	0
SJS	Constant for source-side two-step second junction	—	0
SJSWD	Constant for drain-side sidewall two-step second junction	—	0
SJSWGD	Constant for source-side gate sidewall two-step second junction	—	0
SJSWGS	Constant for source-side gate sidewall two-step second junction	—	0
SJSWS	Constant for source-side sidewall two-step second junction	—	0
TBGASUB	Bandgap temperature coefficient	—	0.000702
TGBSUB	Bandgap temperature coefficient	K	1108
TCJ	Temperature coefficient for CJS/CJD	—	0
TCJSW	Temperature coefficient for CJSWS/CJSWD	—	0
TCJSWG	Temperature coefficient for CJSWGS/CJSWGD	—	0
TEMPMOD	1: Change temperature dependence of specific parameters	—	0

Table 2-130. BSIM-CMG FINFET v110.0.0 Device Model Parameters

Parameter	Description	Units	Default
TETA0	Temperature dependence of DIBL coefficient	—	0
TETA0R	Temperature dependence of reverse-mode DIBL coefficient	—	0
TFIN	Body (fin) thickness	m	1.5e-08
TFIN_BASE	Base body (fin) thickness for trapezoidal triple gate	m	1.5e-08
TFIN_TOP	Top body (fin) thickness for trapezoidal triple gate	m	1.5e-08
TGATE	Gate height on top of the hard mask	m	3e-08
TGIDL	GIDL/GISL temperature dependence	—	-0.003
THETADIBL	DIBL length dependence. If defined by user, will overwrite Theta_DIBL in the code	—	0
THETASCE	Vth roll-off length dependence. If defined by user, it will overwrite Theta_SCE in the code	—	0
THETASW	Subthreshold swing length dependence. If defined by user, it will overwrite Theta_SW in the code	—	0
III	Impact ionization temperature dependence for IIMOD = 2	—	0
TMASK	Height of hard mask on top of the fin	m	3e-08
TMEXP	Temperature coefficient for Vdseff smoothing	—	0
TMEXPR	Reverse-mode temperature coefficient for Vdseff smoothing	—	0
TNJTS	Temperature coefficient for NJTS	—	0
TNJTSD	Temperature coefficient for NJTSD	—	0
TNJTSSW	Temperature coefficient for NJTSSW	—	0
TNJTSSWD	Temperature coefficient for NJTSSWD	—	0
TNJTSSWG	Temperature coefficient for NJTSSWG	—	0
TNJTSSWGD	Temperature coefficient for NJTSSWGD	—	0
TNOIA	Thermal noise parameter	—	1.5
TNOIB	Thermal noise parameter	—	3.5
TNOIC	Thermal noise parameter for TNOIMOD=1	—	3.5
TNOIMOD	0: Charge-based, 1: Correlated thermal noise model	—	0
TNOM	Temperature at which the model is extracted	—	27
TOXG	Oxide thickness for gate current model	m	0
TOXP	Physical oxide thickness	m	1.2e-09
TOXREF	Target tox value	m	1.2e-09
TPB	Temperature coefficient for PBS/PBD	—	0
TPBSW	Temperature coefficient for PBSWS/PBSWD	—	0
TPBSWG	Temperature coefficient for PBSWGS/PBSWGD	—	0
TRDDR	Drain-side drift resistance temperature coefficient	—	0

Table 2-130. BSIM-CMG FINFET v110.0.0 Device Model Parameters

Parameter	Description	Units	Default
TRSDR	Source-side drift resistance temperature coefficient	—	0
TSILI	Thickness of the silicide on top of the raised source/drain	m	1e-08
TSS	Swing temperature coefficient	—	0
TYPE	0: PMOS; 1: NMOS	—	0
U0	Low-field mobility	—	0.03
U0LT	Coupled NFIN and length dependence of U0	—	0
U0MULT	Variability in carrier mobility	—	1
U0N1	NFIN dependence of U0	—	0
U0N1R	Reverse-mode NFIN dependence of U0	—	0
U0N2	NFIN dependence of U0	—	100000
U0N2R	Reverse-mode NFIN dependence of U0	—	0
U0R	Reverse-mode low-field mobility	—	0
UA	Phonon/surface roughness scattering parameter	—	0.3
UA1	Mobility temperature coefficient for UA	—	0.001032
UA1R	Reverse-mode mobility temperature coefficient for UA	—	0
UAR	Reverse-mode phonon/surface roughness scattering parameter	—	0
UC	Body effect for mobility degradation parameter - BULKMOD=1 or 2	—	0
UC1	Mobility temperature coefficient for UC	—	5.6e-11
UC1R	Reverse-mode mobility temperature coefficient for UC	—	0
UCR	Reverse-mode body effect for mobility degradation parameter - BULKMOD=1 or 2	—	0
UCS	Columbic scattering parameter	—	1
UCSTE	Mobility temperature coefficient	—	-0.004775
UD	Columbic scattering parameter	—	0
UD1	Mobility temperature coefficient for UC	—	0
UD1R	Reverse-mode mobility temperature coefficient for UD	—	0
UDR	Reverse-mode columbic scattering parameter	—	0
UP	Mobility L coefficient	—	0
UPR	Reverse-mode mobility L coefficient	—	0
UTE	Mobility temperature coefficient	—	0
UTER	Reverse-mode for mobility temperature coefficient	—	0
UTL	Mobility temperature coefficient	—	-0.0015
UTLR	Reverse-mode for mobility temperature coefficient	—	0
VFBSD	Flatband voltage for S/D region	V	0

Table 2-130. BSIM-CMG FINFET v110.0.0 Device Model Parameters

Parameter	Description	Units	Default
VFBSDCV	Flatband voltage for S/D region for C-V calculations	V	0
VSAT	Saturation velocity for the saturation region	—	85000
VSAT1	Velocity saturation parameter for Ion degradation - forward mode	—	0
VSAT1N1	NFIN dependence of VSAT1	—	0
VSAT1N2	NFIN dependence of VSAT1	—	0
VSAT1R	Velocity saturation parameter for Ion degradation - reverse mode	—	0
VSAT1RN1	NFIN dependence of VSAT1R	—	0
VSAT1RN2	NFIN dependence of VSAT1R	—	0
VSATCV	Velocity saturation parameter for CV	—	0
VSATN1	NFIN dependence of VSAT	—	0
VSATN2	NFIN dependence of VSAT	—	100000
VSATR	Saturation velocity for the saturation region in the reverse mode	—	0
VSATRN1	NFIN dependence of VSATR	—	0
VSATRN2	NFIN dependence of VSATR	—	0
VTSD	Bottom drain junction trap-assisted current voltage dependent parameter	V	0
VTSS	Bottom source junction trap-assisted current voltage dependent parameter	V	10
VTSSWD	Unit length trap-assisted current voltage dependent parameter for sidewall drain junction	V	0
VTSSWGD	Unit length trap-assisted current voltage dependent parameter for gate-edge sidewall drain junction	V	0
VTSSWGS	Unit length trap-assisted current voltage dependent parameter for gate-edge sidewall source junction	V	10
VTSSWS	Unit length trap-assisted current voltage dependent parameter for sidewall source junction	V	10
W_UFCM	Effective channel width for the unified Model	m	1
WR	W dependence parameter of S/D extension resistance	—	1
WTH0	Width dependence coefficient for Rth and Cth	m	0
XJBVD	Fitting parameter for drain diode breakdown current	—	0
XJBVS	Fitting parameter for source diode breakdown current	—	1
XL	L offset for channel length due to mask/etch effect	m	0
XRCRG1	Parameter for non-quasistatic gate resistance (NQSMOD = 1) and NQSMOD = 2	—	12
XRCRG2	Parameter for non-quasistatic gate resistance (NQSMOD = 1) and NQSMOD = 2	—	1

Table 2-130. BSIM-CMG FINFET v110.0.0 Device Model Parameters

Parameter	Description	Units	Default
XTID	Drain junction current temperature exponent	—	0
XTIS	Source junction current temperature exponent	—	3
XTSD	Power dependence of JTSD on temperature	—	0
XTSS	Power dependence of JTSS on temperature	—	0.02
XTSSWD	Power dependence of JTSSWD on temperature	—	0
XTSSWGD	Power dependence of JTSSWGD on temperature	—	0
XTSSWGS	Power dependence of JTSSWGS on temperature	—	0.02
XTSSWS	Power dependence of JTSSWS on temperature	—	0.02

Table 2-131. MOSFET level 110 Output Variables

Parameter	Description	Units	Default
WEFF	WEFF	—	none
LEFF	LEFF	—	none
WEFFCV	WEFFCV	—	none
LEFFCV	LEFFCV	—	none
IDS	IDS	—	none
IDEFF	IDEFF	—	none
ISEFF	ISEFF	—	none
IGTOT	IGTOT	—	none
IDSGEN	IDSGEN	—	none
III	III	—	none
IGS	IGS	—	none
IGD	IGD	—	none
IGCS	IGCS	—	none
IGCD	IGCD	—	none
IGBS	IGBS	—	none
IGBD	IGBD	—	none
IGIDL	IGIDL	—	none
IGISL	IGISL	—	none
IJSB	IJSB	—	none
IJDB	IJDB	—	none
ISUB	ISUB	—	none
BETA	BETA	—	none
VTH	VTH	—	none
VDSSAT	VDSSAT	—	none

Table 2-131. MOSFET level 110 Output Variables

Parameter	Description	Units	Default
VFB	VFB	–	none
GM	GM	–	none
GDS	GDS	–	none
GMBS	GMBS	–	none
QGI	QGI	–	none
QDI	QDI	–	none
QSI	QSI	–	none
QBI	QBI	–	none
QG	QG	–	none
QD	QD	–	none
QS	QS	–	none
QB	QB	–	none
CGGI	CGGI	–	none
CGSI	CGSI	–	none
CGDI	CGDI	–	none
CGEI	CGEI	–	none
CDGI	CDGI	–	none
CDDI	CDDI	–	none
CDSI	CDSI	–	none
CDEI	CDEI	–	none
CSGI	CSGI	–	none
CSDI	CSDI	–	none
CSSI	CSSI	–	none
CSEI	CSEI	–	none
CEGI	CEGI	–	none
CEDI	CEDI	–	none
CESI	CESI	–	none
CEEI	CEEI	–	none
CGG	CGG	–	none
CGS	CGS	–	none
CGD	CGD	–	none
CGE	CGE	–	none
CDG	CDG	–	none
CDD	CDD	–	none
CDS	CDS	–	none
CDE	CDE	–	none

Table 2-131. MOSFET level 110 Output Variables

Parameter	Description	Units	Default
CSG	CSG	–	none
CSD	CSD	–	none
CSS	CSS	–	none
CSE	CSE	–	none
CEG	CEG	–	none
CED	CED	–	none
CES	CES	–	none
CEE	CEE	–	none
CGSEXT	CGSEXT	–	none
CGDEXT	CGDEXT	–	none
CGBOV	CGBOV	–	none
CJST	CJST	–	none
CJDT	CJDT	–	none
RSGEO	RSGEO	–	none
RDGEO	RDGEO	–	none
CFGEO	CFGEO	–	none
T_TOTAL_K	T_TOTAL_K	–	none
T_TOTAL_C	T_TOTAL_C	–	none
T_DELTA_SH	T_DELTA_SH	–	none
IGBACC	IGBACC	–	none
IGBINV	IGBINV	–	none
DIDSDVG	DIDSDVG	–	none
DIDSDVS	DIDSDVS	–	none
DIDSDVD	DIDSDVD	–	none
DIGSDVG	DIGSDVG	–	none
DIGSDVS	DIGSDVS	–	none
DIGSDVD	DIGSDVD	–	none
DIGDDVG	DIGDDVG	–	none
DIGDDVS	DIGDDVS	–	none
DIGDDVD	DIGDDVD	–	none
DIIIDVG	DIIIDVG	–	none
DIIIDVS	DIIIDVS	–	none
DIIIDVD	DIIIDVD	–	none
DIGIDLVDG	DIGIDLVDG	–	none
DIGIDLVS	DIGIDLVS	–	none
DIGILDVD	DIGILDVD	–	none

Table 2-131. MOSFET level 110 Output Variables

Parameter	Description	Units	Default
DIGISLDVG	DIGISLDVG	–	none
DIGISLDVS	DIGISLDVS	–	none
DIGISLDVD	DIGISLDVD	–	none
CGT	CGT	–	none
CST	CST	–	none
CDT	CDT	–	none
DIDSDVTH	DIDSDVTH	–	none
DIGSDVTH	DIGSDVTH	–	none
DIGDDVTH	DIGDDVTH	–	none
DIIDVTH	DIIDVTH	–	none
DIGIDLVDVTH	DIGIDLVDVTH	–	none
DIGISLDVTH	DIGISLDVTH	–	none
DITHDVTH	DITHDVTH	–	none
ITH	ITH	–	none
DITHDVG	DITHDVG	–	none
DITHDVS	DITHDVS	–	none
DITHDVD	DITHDVD	–	none
VDSAT	Synonym for VDSSAT	–	none
VDS	Drain-source voltage	–	none
VGS	Gate-source voltage	–	none
VBS	Bulk-source voltage	–	none

2.3.20.15. Level 107 and 108 MOSFET Tables (BSIM CMG versions 107.0.0 and 108.0.0)

Xyce includes the legacy BSIM CMG Common Multi-gate model versions 107 and 108. These models have been superseded by the level 110 version, but has been retained for backward compatibility with previous versions of Xyce and older model cards and PDKs. The code in Xyce was generated from the BSIM group’s Verilog-A input using the default “ifdef” lines provided, and therefore supports only the subset of BSIM CMG features those defaults enable. Instance and model parameters for the BSIM CMG model are given in tables 2-132, 2-133, 2-135, and 2-136. Details of the model are documented in the BSIM-CMG technical report[30], available from the BSIM web site at <http://bsim.berkeley.edu/models/bsimcmg/>.

Note that the TNOIMOD=1 option of BSIM-CMG 108 is not supported in Xyce, as it uses features of Verilog-A that are not supported in our Verilog-A compiler. This noise model was added in version 108 and removed in version 109. The TNOIMOD=2 option of BSIM-CMG 108 is the same as the TNOIMOD=1 option of BSIM-CMG 110.

Table 2-132. BSIM-CMG FINFET v107.0.0 Device Instance Parameters

Parameter	Description	Units	Default
ADEJ	Drain junction area (BULKMOD=1)	–	0
ADEO	Drain to substrate overlap area through oxide	–	0
ASEJ	Source junction area (BULKMOD=1)	–	0
ASEO	Source to substrate overlap area through oxide	–	0
CDSP	Constant drain-to-source fringe capacitance (All CGEOMOD)	–	0
CGDP	Constant gate-to-drain fringe capacitance (CGEOMOD=1)	–	0
CGSP	Constant gate-to-source fringe capacitance (CGEOMOD=1)	–	0
COVD	Constant g/d overlap capacitance (CGEOMOD=1)	–	0
COVS	Constant g/s overlap capacitance (CGEOMOD=1)	–	0
D	Diameter of the cylinder (GEOMOD=3)	–	4e-08
FPITCH	Fin pitch	–	8e-08
L	Designed Gate Length	–	3e-08
LRSD	Length of the source/drain	–	0
NFIN	Number of fins per finger (real number enables optimization)	–	1
NGCON	number of gate contact (1 or 2 sided)	–	1
NRD	Number of source diffusion squares	–	0
NRS	Number of source diffusion squares	–	0
PDEJ	Drain to substrate PN junction perimeter (BULKMOD=1)	–	0
PDEO	Perimeter of drain to substrate overlap region through oxide	–	0
PSEJ	Source to substrate PN junction perimeter (BULKMOD=1)	–	0
PSEO	Perimeter of source to substrate overlap region through oxide	–	0
TFIN	Body (Fin) thickness	–	1.5e-08

Table 2-133. BSIM-CMG FINFET v107.0.0 Device Model Parameters

Parameter	Description	Units	Default
A1	Non-saturation effect parameter for strong inversion region	–	0
A11	Temperature dependence of A1	–	0
A2	Non-saturation effect parameter for moderate inversion region	–	0

Table 2-133. BSIM-CMG FINFET v107.0.0 Device Model Parameters

Parameter	Description	Units	Default
A21	Temperature dependence of A2	–	0
ADEJ	Drain junction area (BULKMOD=1)	–	0
ADEO	Drain to substrate overlap area through oxide	–	0
AEU		–	0
AGIDL	pre-exponential coeff. for GIDL in mho	–	0
AGISL	pre-exponential coeff. for GISL in mho	–	6.055e-12
AIGBACC	parameter for Igb in accumulation	–	0.0136
AIGBACC1	parameter for Igb in accumulation	–	0
AIGBINV	parameter for Igb in inversion	–	0.0111
AIGBINV1	parameter for Igb in inversion	–	0
AIGC	parameter for Igc in inversion	–	0.0136
AIGC1	parameter for Igc in inversion	–	0
AIGD	parameter for Igd in inversion	–	0
AIGD1	parameter for Igd in inversion	–	0
AIGEN	Thermal Generation Current Parameter	–	0
AIGS	parameter for Igs in inversion	–	0.0136
AIGS1	parameter for Igs in inversion	–	0
ALPHA0	first parameter of Iii	m/V	0
ALPHA01	Temperature dependence of ALPHA0, m/V/degrees	–	0
ALPHA1	L scaling parameter of Iii	V ⁻¹	0
ALPHA11	Temperature dependence ALPHA1, 1/V/degree	–	0
ALPHAI0	first parameter of Iii for IIMOD=2, m/V	–	0
ALPHAI01	Temperature dependence of ALPHAI0, m/V/degrees	–	0
ALPHAI1	L scaling parameter of Iii for IIMOD=2	V ⁻¹	0
ALPHAI11	Temperature dependence of ALPHAI1, 1/V/degrees	–	0
AMEXP		–	0
AMEXPR		–	0
APCLM		–	0
APSAT		–	0
APSATCV		–	0
APTWG		–	0
AQMTCCN	Parameter for Geometric dependence of Tcen on R/TFIN/HFIN	–	0
ARDSW		–	0
ARDW		–	0
ARSDEND		–	0

Table 2-133. BSIM-CMG FINFET v107.0.0 Device Model Parameters

Parameter	Description	Units	Default
ARSW		–	0
ASEJ	Source junction area (BULKMOD=1)	–	0
ASEO	Source to substrate overlap area through oxide	–	0
ASILIEND		–	0
ASYMMOD	Asymmetric model selector	–	0
AT		–	-0.00156
AUA		–	0
AUD		–	0
AVSAT		–	0
AVSAT1		–	0
AVSATCV		–	0
BETA0	Vds dependent parameter of Iii	V ⁻¹	0
BETAI0	Vds dependent parameter of Iii	V ⁻¹	0
BETAI1	Vds dependent parameter of Iii	–	0
BETAI2	Vds dependent parameter of Iii, V	–	0.1
BEU		–	1e-07
BG0SUB	Band gap of substrate at 300.15K, eV	–	1.12
BGIDL	exponential coeff. for GIDL	V/m	0
BGISL	exponential coeff. for GISL	V/m	3e+08
BIGBACC	parameter for Igb in accumulation	–	0.00171
BIGBINV	parameter for Igb in inversion	–	0.000949
BIGC	parameter for Igc in inversion	–	0.00171
BIGD	parameter for Igd in inversion	–	0
BIGEN	Thermal Generation Current Parameter	–	0
BIGS	parameter for Igs in inversion	–	0.00171
BMEXP		–	1
BMEXPR		–	0
BPCLM		–	1e-07
BPSAT		–	1
BPSATCV		–	0
BPTWG		–	1e-07
BQMTCEN	Parameter for Geometric dependence of Tcen on R/TFIN/HFIN	–	1.2e-08
BRDSW		–	1e-07
BRDW		–	1e-07
BRSW		–	1e-07

Table 2-133. BSIM-CMG FINFET v107.0.0 Device Model Parameters

Parameter	Description	Units	Default
BUA		–	1e-07
BUD		–	5e-08
BULKMOD	Bulk model	–	0
BVD	Drain diode breakdown voltage	–	0
BVS	Source diode breakdown voltage	–	10
BVSAT		–	1e-07
BVSAT1		–	0
BVSATCV		–	0
CAPMOD	Accumulation region capacitance model selector	–	0
CDSC	coupling capacitance between S/D and channel	–	0.007
CDSCD	drain-bias sensitivity of CDSC	–	0.007
CDSCDN1	NFIN dependence of CDSCD	–	0
CDSCDN2	NFIN dependence of CDSCD	–	100000
CDSCDR	Reverse-mode drain-bias sensitivity of CDSC (Experimental)	–	0
CDSCDRN1	NFIN dependence of CDSCD	–	0
CDSCDRN2	NFIN dependence of CDSCD	–	0
CDSCN1	NFIN dependence of CDSC	–	0
CDSCN2	NFIN dependence of CDSC	–	100000
CDSP	Constant drain-to-source fringe capacitance (All CGEOMOD)	–	0
CFD	Outer Fringe Cap (drain side)	–	0
CFS	Outer Fringe Cap (source side)	–	2.5e-11
CGBL	Bias dependent component of Gate to substrate overlap cap	–	0
CGBN	Gate to substrate overlap cap per unit channel length per fin per finger	–	0
CGBO	Gate to substrate overlap cap per unit channel length per finger per NGCON	–	0
CGDL		–	0
CGDO	Non LDD region drain-gate overlap capacitance per unit channel width	–	0
CGDP	Constant gate-to-drain fringe capacitance (CGEOMOD=1)	–	0
CGEO1SW		–	0
CGEOA	Fitting parameter for CGEOMOD=2	–	1
CGEOB	Fitting parameter for CGEOMOD=2	–	0
CGEOC	Fitting parameter for CGEOMOD=2	–	0

Table 2-133. BSIM-CMG FINFET v107.0.0 Device Model Parameters

Parameter	Description	Units	Default
CGEOD	Fitting parameter for CGEOMOD=2	–	0
CGEOE	Fitting parameter for CGEOMOD=2	–	1
CGEOMOD	parasitic capacitance model selector	–	0
CGIDL	parameter for body-effect of GIDL	V ³	0
CGISL	parameter for body-effect of GISL	V ³	0.5
CGSL		–	0
CGSO	Non LDD region source-gate overlap capacitance per unit channel width	–	0
CGSP	Constant gate-to-source fringe capacitance (CGEOMOD=1)	–	0
CHARGEWF	Average Channel Charge Weighting Factor, +1:source-side, 0:middle, -1:drain-side	–	0
CIGBACC	parameter for Igb in accumulation	–	0.075
CIGBINV	parameter for Igb in inversion	–	0.006
CIGC	parameter for Igc in inversion	–	0.075
CIGD	parameter for Igd in inversion	–	0
CIGS	parameter for Igs in inversion	–	0.075
CIT	parameter for interface trap	–	0
CJD	Unit area drain-side junction capacitance at zero bias	–	0
CJS	Unit area source-side junction capacitance at zero bias	–	0.0005
CJSWD	Unit length drain-side sidewall junction capacitance at zero bias	–	0
CJSWGD	Unit length drain-side gate sidewall junction capacitance at zero bias	–	0
CJSWGS	Unit length source-side gate sidewall junction capacitance at zero bias	–	0
CJSWS	Unit length source-side sidewall junction capacitance at zero bias	–	5e-10
CKAPPAB		–	0.6
CKAPPAD		–	0
CKAPPAS		–	0.6
COREMOD	Surface potential algorithm	–	0
COVD	Constant g/d overlap capacitance (CGEOMOD=1)	–	0
COVS	Constant g/s overlap capacitance (CGEOMOD=1)	–	0
CRATIO		–	0.5
CSDESW	Coefficient for source/drain to substrate sidewall cap	–	0
CTH0	Thermal capacitance	–	1e-05
D	Diameter of the cylinder (GEOMOD=3)	–	4e-08

Table 2-133. BSIM-CMG FINFET v107.0.0 Device Model Parameters

Parameter	Description	Units	Default
DELTAPRSD		–	0
DELTAVSAT		–	1
DELTAVSATCV		–	0
DELTAW	change of effective width due to shape of fin/cylinder	–	0
DELTAWCV	CV change of effective width due to shape of fin/cylinder	–	0
DELVFBACC	Change in Flatband Voltage; Vfb_accumulation-Vfb_inversion	–	0
DELVTRAND	Variability in Vth	–	0
DEVTYPE		–	1
DLBIN	Delta L for Binning	–	0
DLC	Delta L for C-V model	–	0
DLCACC	Delta L for C-V model in accumulation region (CAPMOD=1, BULKMOD=1)	–	0
DLCIGD	Delta L for Igd model	–	0
DLCIGS	Delta L for Igs model	–	0
DROUT		–	1.06
DSUB	DIBL exponent coefficient	–	1.06
DTEMP	Variability in Device Temperature	–	0
DVT0	SCE coefficient	–	0
DVT1	SCE exponent coefficient, after binning should be in (0:inf)	–	0.6
DVT1SS	Subthreshold Swing exponent coefficient, after binning should be in (0:inf)	–	0
DVTP0	Coefficient for Drain-Induced Vth Shift (DITS)	–	0
DVTP1	DITS exponent coefficient	–	0
DVTSHIFT	Vth shift handle	–	0
EASUB	Electron affinity of substrate, eV	–	4.05
EF		–	1
EGIDL	band bending parameter for GIDL	V	0
EGISL	band bending parameter for GISL	V	0.2
EIGBINV	parameter for Igb in inversion	–	1.1
EM		–	4.1e+07
EMOBT		–	0
EOT	equivalent oxide thickness in meters	–	1e-09
EOTACC	equivalent oxide thickness for accumulation region in meters	m	0

Table 2-133. BSIM-CMG FINFET v107.0.0 Device Model Parameters

Parameter	Description	Units	Default
EOTBOX	equivalent oxide thickness of the buried oxide (SOI FinFET) or STI (bulk FinFET) in meters	–	1.4e-07
EPSROX	Relative dielectric constant of the gate dielectric	–	3.9
EPSRSP	Relative dielectric constant of the spacer	–	3.9
EPSRSUB	Relative dielectric constant of the channel material	–	11.9
ESATII	Saturation channel E-Field for Iii	V/m	1e+07
ETA0	DIBL coefficient	–	0.6
ETA0N1	NFIN dependence of ETA0	–	0
ETA0N2	NFIN dependence of ETA0	–	100000
ETA0R	Reverse-mode DIBL coefficient (Experimental)	–	0
ETAMOB		–	2
ETAQM	Bulk charge coefficient for Tcen	–	0.54
EU		–	2.5
FECH	End-channel factor, for different orientation/shape	–	1
FECHCV	CV end-channel factor, for different orientaion/shape	–	1
FPITCH	Fin pitch	–	8e-08
GEOMOD	Geometry mode selector	–	1
GIDLMOD	GIDL/GISL current switcher	–	0
HEPI	Height of the raised source/drain on top of the fin	–	1e-08
HFIN	Fin height in meters	–	3e-08
IDS0MULT	Variability in Drain current for misc. reasons	–	1
IGBMOD	model selector for Igb	–	0
IGCMOD	model selector for Igc, Igs, and Igd	–	0
IGT	Gate Current Temperature Dependence	–	2.5
IIMOD	Impact ionization model switch	–	0
IIT	Impact Ionization Temperature Dependence, IIMOD=1	–	-0.5
IJTHDFWD	Forward drain diode breakdown limiting current	–	0
IJTHDREV	Reverse drain diode breakdown limiting current	–	0
IJTHSFWD	Forward source diode breakdown limiting current	–	0.1
IJTHSREV	Reverse source diode breakdown limiting current	–	0.1
IMIN	Parameter for Vgs Clamping for inversion region calc. in accumulation	–	1e-15
JSD	Bottom drain junction reverse saturation current density	–	0
JSS	Bottom source junction reverse saturation current density	–	0.0001

Table 2-133. BSIM-CMG FINFET v107.0.0 Device Model Parameters

Parameter	Description	Units	Default
JSWD	Unit length reverse saturation current for sidewall drain junction	–	0
JSWGD	Unit length reverse saturation current for gate-edge sidewall drain junction	–	0
JSWGS	Unit length reverse saturation current for gate-edge sidewall source junction	–	0
JSWS	Unit length reverse saturation current for sidewall source junction	–	0
JTSD	Bottom drain junction trap-assisted saturation current density	–	0
JTSS	Bottom source junction trap-assisted saturation current density	–	0
JTSSWD	Unit length trap-assisted saturation current for sidewall drain junction	–	0
JTSSWGD	Unit length trap-assisted saturation current for gate-edge sidewall drain junction	–	0
JTSSWGS	Unit length trap-assisted saturation current for gate-edge sidewall source junction	–	0
JTSSWS	Unit length trap-assisted saturation current for sidewall source junction	–	0
JTWEFF	Trap assisted tunneling current width dependence	–	0
K0	Lateral NUD voltage parameter, V	–	0
K01	Temperature dependence of lateral NUD voltage parameter, V/K	–	0
K0SI	Correction factor for strong inversion, used in Mnud, after binnig should be from (0:inf)	–	1
K0SI1	Temperature dependence of K0SI, 1/K	–	0
K1	Body effect coefficient for sub-threshold region	–	0
K11	Temperature dependence of K1	–	0
K1RSCE	K1 for reverse short channel effect calculation	–	0
K1SAT	Correction factor for K1 in saturation (high Vds)	–	0
K1SAT1	Temperature dependence of K1SAT1	–	0
K1SI	Correction factor for strong inversion, used in Mob	–	0
K1SI1	Temperature dependence of K1SI, 1/K	–	0
KSATIV		–	1
KT1	Vth Temperature Coefficient (V)	–	0
KT1L	Vth Temperature L Coefficient (m-V)	–	0
L	Designed Gate Length	–	3e-08
LA1		–	0

Table 2-133. BSIM-CMG FINFET v107.0.0 Device Model Parameters

Parameter	Description	Units	Default
LA11		–	0
LA2		–	0
LA21		–	0
LAGIDL		–	0
LAGISL		–	0
LAIGBACC		–	0
LAIGBACC1		–	0
LAIGBINV		–	0
LAIGBINV1		–	0
LAIGC		–	0
LAIGC1		–	0
LAIGD		–	0
LAIGD1		–	0
LAIGEN		–	0
LAIGS		–	0
LAIGS1		–	0
LALPHA0		–	0
LALPHA1		–	0
LALPHAI0		–	0
LALPHAI1		–	0
LAT		–	0
LBETA0		–	0
LBETAI0		–	0
LBETAI1		–	0
LBETAI2		–	0
LBGIDL		–	0
LBGISL		–	0
LBIGBACC		–	0
LBIGBINV		–	0
LBIGC		–	0
LBIGD		–	0
LBIGEN		–	0
LBIGS		–	0
LCDSC		–	0
LCDSCL		–	0
LCDSCLR		–	0

Table 2-133. BSIM-CMG FINFET v107.0.0 Device Model Parameters

Parameter	Description	Units	Default
LCFD		-	0
LCFS		-	0
LCGBL		-	0
LCGDL		-	0
LCGIDL		-	0
LCGISL		-	0
LCGSL		-	0
LCIGBACC		-	0
LCIGBINV		-	0
LCIGC		-	0
LCIGD		-	0
LCIGS		-	0
LCIT		-	0
LCKAPPAB		-	0
LCKAPPAD		-	0
LCKAPPAS		-	0
LCOVD		-	0
LCOVS		-	0
LDELTAVSAT		-	0
LDELTAVSATCV		-	0
LDROUT		-	0
LDSUB		-	0
LDVT0		-	0
LDVT1		-	0
LDVT1SS		-	0
LDVTB		-	0
LDVTSHIFT		-	0
LEGIDL		-	0
LEGISL		-	0
LEIGBINV		-	0
LEMOBT		-	0
LESATII		-	0
LETA0		-	0
LETA0R		-	0
LETAMOB		-	0
LEU		-	0

Table 2-133. BSIM-CMG FINFET v107.0.0 Device Model Parameters

Parameter	Description	Units	Default
LIGT		–	0
LII	Channel length dependent parameter of Iii	Vm	5e-10
LIIT		–	0
LINT	Length reduction parameter (dopant diffusion effect)	–	0
LINTIGEN	Lint for Thermal Generation Current	–	0
LINTNOI		–	0
LK0		–	0
LK01		–	0
LK0SI		–	0
LK0SI1		–	0
LK1		–	0
LK11		–	0
LK1RSCE		–	0
LK1SAT		–	0
LK1SAT1		–	0
LK1SI		–	0
LK1SI1		–	0
LKSATIV		–	0
LKT1		–	0
LL	Length reduction parameter (dopant diffusion effect)	–	0
LLC	Length reduction parameter (dopant diffusion effect)	–	0
LLII		–	0
LLN	Length reduction parameter (dopant diffusion effect)	–	1
LLPE0		–	0
LLPEB		–	0
LMEXP		–	0
LMEXPR		–	0
LNBODY		–	0
LNGATE		–	0
LNIGBACC		–	0
LNIGBINV		–	0
LNTGEN		–	0
LNTOX		–	0
LPA		–	1
LPCLM		–	0
LPCLMCV		–	0

Table 2-133. BSIM-CMG FINFET v107.0.0 Device Model Parameters

Parameter	Description	Units	Default
LPCLMG		–	0
LPDIBL1		–	0
LPDIBL1R		–	0
LPDIBL2		–	0
LPE0	Equivalent length of pocket region at zero bias	–	5e-09
LPGIDL		–	0
LPGISL		–	0
LPHIBE		–	0
LPHIG		–	0
LPHIN		–	0
LPIGCD		–	0
LPOXEDGE		–	0
LPRT		–	0
LPRWGD		–	0
LPRWGS		–	0
LPSAT		–	0
LPSATCV		–	0
LPTWG		–	0
LPTWGR		–	0
LPTWGT		–	0
LPVAG		–	0
LQMFACTOR		–	0
LQMCENCV		–	0
LQMCENCVA		–	0
LQMCENIV		–	0
LRDSW		–	0
LRDW		–	0
LRSD	Length of the source/drain	–	0
LRSW		–	0
LSII0		–	0
LSII1		–	0
LSII2		–	0
LSIID		–	0
LSP		–	0
LSTTHETASAT		–	0
LTGIDL		–	0

Table 2-133. BSIM-CMG FINFET v107.0.0 Device Model Parameters

Parameter	Description	Units	Default
LTII		–	0
LTSS		–	0
LU0		–	0
LUA		–	0
LUA1		–	0
LUC		–	0
LUC1		–	0
LUCS		–	0
LUCSTE		–	0
LUD		–	0
LUD1		–	0
LUP		–	0
LUTE		–	0
LUTL		–	0
LVSAT		–	0
LVSAT1		–	0
LVSAT1R		–	0
LVSATCV		–	0
LWR		–	0
LXRCRG1		–	0
LXRCRG2		–	0
MEXP		–	4
MEXPR		–	0
MJD	Drain bottom junction capacitance grading coefficient	–	0
MJD2	Drain bottom two-step second junction capacitance grading coefficient	–	0
MJS	Source bottom junction capacitance grading coefficient	–	0.5
MJS2	Source bottom two-step second junction capacitance grading coefficient	–	0.125
MJSWD	Drain sidewall junction capacitance grading coefficient	–	0
MJSWD2	Drain sidewall two-step second junction capacitance grading coefficient	–	0
MJSWGD	Drain-side gate sidewall junction capacitance grading coefficient	–	0
MJSWGD2	Drain-side gate sidewall two-step	–	0

Table 2-133. BSIM-CMG FINFET v107.0.0 Device Model Parameters

Parameter	Description	Units	Default
MJSWGS	Source-side gate sidewall junction capacitance grading coefficient	–	0
MJSWGS2	Source-side gate sidewall two-step	–	0
MJSWS	Source sidewall junction capacitance grading coefficient	–	0.33
MJSWS2	Source sidewall two-step second junction capacitance grading coefficient	–	0.083
NA1		–	0
NA11		–	0
NA2		–	0
NA21		–	0
NAGIDL		–	0
NAGISL		–	0
NAIGBACC		–	0
NAIGBACC1		–	0
NAIGBINV		–	0
NAIGBINV1		–	0
NAIGC		–	0
NAIGC1		–	0
NAIGD		–	0
NAIGD1		–	0
NAIGEN		–	0
NAIGS		–	0
NAIGS1		–	0
NALPHA0		–	0
NALPHA1		–	0
NALPHAI0		–	0
NALPHAI1		–	0
NAT		–	0
NBETA0		–	0
NBETAI0		–	0
NBETAI1		–	0
NBETAI2		–	0
NBGIDL		–	0
NBGISL		–	0
NBIGBACC		–	0
NBIGBINV		–	0

Table 2-133. BSIM-CMG FINFET v107.0.0 Device Model Parameters

Parameter	Description	Units	Default
NBIGC		–	0
NBIGD		–	0
NBIGEN		–	0
NBIGS		–	0
NBODY	channel (body) doping	–	1e+22
NBODYN1	NFIN dependence of channel (body) doping	–	0
NBODYN2	NFIN dependence of channel (body) doping	–	100000
NC0SUB	Conduction band density of states, m-3	–	2.86e+25
NCDS		–	0
NCDS		–	0
NCDS		–	0
NCDF		–	0
NCFS		–	0
NCGBL		–	0
NCGDL		–	0
NCGIDL		–	0
NCGISL		–	0
NCGSL		–	0
NCIGBACC		–	0
NCIGBINV		–	0
NCIGC		–	0
NCIGD		–	0
NCIGS		–	0
NCIT		–	0
NCKAPPAB		–	0
NCKAPPAD		–	0
NCKAPPAS		–	0
NCOVD		–	0
NCOVS		–	0
NDELTAVSAT		–	0
NDELTAVSATCV		–	0
NDROUT		–	0
NDSUB		–	0
NDVT0		–	0
NDVT1		–	0
NDVT1SS		–	0

Table 2-133. BSIM-CMG FINFET v107.0.0 Device Model Parameters

Parameter	Description	Units	Default
NDVTB		–	0
NDVTSHIFT		–	0
NEGIDL		–	0
NEGISL		–	0
NEIGBINV		–	0
NEMOBT		–	0
NESATII		–	0
NETA0		–	0
NETA0R		–	0
NETAMOB		–	0
NEU		–	0
NF	Number of fingers	–	1
NFIN	Number of fins per finger (real number enables optimization)	–	1
NGATE	Parameter for Poly Gate Doping, for metal gate please set NGATE = 0	–	0
NGCON	number of gate contact (1 or 2 sided)	–	1
NI0SUB	Intrinsic carrier constant at 300.15K, m-3	–	1.1e+16
NIGBACC	parameter for Igb in accumulation	–	1
NIGBINV	parameter for Igb in inversion	–	3
NIGT		–	0
NIIT		–	0
NJD	Drain junction emission coefficient	–	0
NJS	Source junction emission coefficient	–	1
NJTS	Non-ideality factor for JTSS	–	20
NJTSD	Non-ideality factor for JTSD	–	0
NJTSSW	Non-ideality factor for JTSSWS	–	20
NJTSSWD	Non-ideality factor for JTSSWD	–	0
NJTSSWG	Non-ideality factor for JTSSWGS	–	20
NJTSSWGD	Non-ideality factor for JTSSWGD	–	0
NK0		–	0
NK01		–	0
NK0SI		–	0
NK0SI1		–	0
NK1		–	0
NK11		–	0

Table 2-133. BSIM-CMG FINFET v107.0.0 Device Model Parameters

Parameter	Description	Units	Default
NK1RSCE		–	0
NK1SAT		–	0
NK1SAT1		–	0
NK1SI		–	0
NK1SI1		–	0
NKSATIV		–	0
NKT1		–	0
NLII		–	0
NLPE0		–	0
NLPEB		–	0
NMEXP		–	0
NMEXPR		–	0
NNBODY		–	0
NNGATE		–	0
NNIGBACC		–	0
NNIGBINV		–	0
NNTGEN		–	0
NNTOX		–	0
NOIA		–	6.25e+39
NOIB		–	3.125e+24
NOIC		–	8.75e+07
NPCLM		–	0
NPCLMCV		–	0
NPCLMG		–	0
NPDI1B1		–	0
NPDI1B1R		–	0
NPDI1B2		–	0
NPGIDL		–	0
NPGISL		–	0
NPHIBE		–	0
NPHIG		–	0
NPHIN		–	0
NPIGCD		–	0
NPOXEDGE		–	0
NPRT		–	0
NPRWGD		–	0

Table 2-133. BSIM-CMG FINFET v107.0.0 Device Model Parameters

Parameter	Description	Units	Default
NPRWGS		–	0
NPSAT		–	0
NPSATCV		–	0
NPTWG		–	0
NPTWGR		–	0
NPTWGT		–	0
NPVAG		–	0
NQMFACTOR		–	0
NQMCENCV		–	0
NQMCENCVA		–	0
NQMCENIV		–	0
NQSMOD		–	0
NRD	Number of source diffusion squares	–	0
NRDSW		–	0
NRDW		–	0
NRS	Number of source diffusion squares	–	0
NRSW		–	0
NSD	Source/drain active doping concentration in m-3	–	2e+26
NSDE	Source/drain active doping concentration at Leff edge	–	2e+25
NSEG	Number of segments for NQSMOD=3 (3,5 and 10 supported)	–	4
NSII0		–	0
NSII1		–	0
NSII2		–	0
NSIID		–	0
NSTHETASAT		–	0
NTGEN	Thermal Generation Current Parameter	–	1
NTGIDL		–	0
NTII		–	0
NTNOI		–	1
NTOX	Exponent for Tox ratio	–	1
NTSS		–	0
NU0		–	0
NUA		–	0
NUA1		–	0
NUC		–	0

Table 2-133. BSIM-CMG FINFET v107.0.0 Device Model Parameters

Parameter	Description	Units	Default
NUC1		–	0
NUCS		–	0
NUCSTE		–	0
NUD		–	0
NUD1		–	0
NUP		–	0
NUTE		–	0
NUTL		–	0
NVSAT		–	0
NVSAT1		–	0
NVSAT1R		–	0
NVSATCV		–	0
NWR		–	0
NXRCRG1		–	0
NXRCRG2		–	0
PA1		–	0
PA11		–	0
PA2		–	0
PA21		–	0
PAGIDL		–	0
PAGISL		–	0
PAIGBACC		–	0
PAIGBACC1		–	0
PAIGBINV		–	0
PAIGBINV1		–	0
PAIGC		–	0
PAIGC1		–	0
PAIGD		–	0
PAIGD1		–	0
PAIGEN		–	0
PAIGS		–	0
PAIGS1		–	0
PALPHA0		–	0
PALPHA1		–	0
PALPHAI0		–	0
PALPHAI1		–	0

Table 2-133. BSIM-CMG FINFET v107.0.0 Device Model Parameters

Parameter	Description	Units	Default
PAT		–	0
PBD	Drain-side bulk junction built-in potential	–	0
PBETA0		–	0
PBETAI0		–	0
PBETAI1		–	0
PBETAI2		–	0
PBGIDL		–	0
PBGISL		–	0
PBIGBACC		–	0
PBIGBINV		–	0
PBIGC		–	0
PBIGD		–	0
PBIGEN		–	0
PBIGS		–	0
PBS	Source-side bulk junction built-in potential	–	1
PBSWD	Built-in potential for Drain-side sidewall junction capacitance	–	0
PBSWGD	Built-in potential for Drain-side gate sidewall junction capacitance	–	0
PBSWGS	Built-in potential for Source-side gate sidewall junction capacitance	–	0
PBSWS	Built-in potential for Source-side sidewall junction capacitance	–	1
PCDSC		–	0
PCDSCD		–	0
PCDSCDR		–	0
PCFD		–	0
PCFS		–	0
PCGBL		–	0
PCGDL		–	0
PCGIDL		–	0
PCGISL		–	0
PCGSL		–	0
PCIGBACC		–	0
PCIGBINV		–	0
PCIGC		–	0
PCIGD		–	0

Table 2-133. BSIM-CMG FINFET v107.0.0 Device Model Parameters

Parameter	Description	Units	Default
PCIGS		–	0
PCIT		–	0
PCKAPPAB		–	0
PCKAPPAD		–	0
PCKAPPAS		–	0
PCLM		–	0.013
PCLMCV	CLM parameter for Short Channel CV	–	0
PCLMG		–	0
PCOVD		–	0
PCOVS		–	0
PDEJ	Drain to substrate PN junction perimeter (BULKMOD=1)	–	0
PDELTAVSAT		–	0
PDELTAVSATCV		–	0
PDEO	Perimeter of drain to substrate overlap region through oxide	–	0
PDIBL1	DIBL Output Conductance parameter - forward mode	–	1.3
PDIBL1R	DIBL Output Conductance parameter - reverse mode	–	0
PDIBL2	DIBL Output Conductance parameter	–	0.0002
PDROUT		–	0
PDSUB		–	0
PDVT0		–	0
PDVT1		–	0
PDVT1SS		–	0
PDVTB		–	0
PDVTSHIFT		–	0
PEGIDL		–	0
PEGISL		–	0
PEIGBINV		–	0
PEMOBT		–	0
PESATII		–	0
PETA0		–	0
PETA0R		–	0
PETAMOB		–	0
PEU		–	0
PGIDL	parameter for body-bias effect on GIDL	–	0

Table 2-133. BSIM-CMG FINFET v107.0.0 Device Model Parameters

Parameter	Description	Units	Default
PGISL	parameter for body-bias effect on GISL	–	1
PHIBE	Body effect voltage parameter, V, after binnig should be from [0.2:1.2]	–	0.7
PHIG	Gate workfunction, eV	–	4.61
PHIGL	Length dependence of Gate workfunction, eV/m	–	0
PHIGN1	NFIN dependence of Gate workfunction	–	0
PHIGN2	NFIN dependence of Gate workfunction	–	100000
PHIN	Nonuniform vertical doping effect on surface potential, V	–	0.05
PIGCD	parameter for Igc partition	–	1
PIGT		–	0
PIIT		–	0
PK0		–	0
PK01		–	0
PK0SI		–	0
PK0SI1		–	0
PK1		–	0
PK11		–	0
PK1RSCE		–	0
PK1SAT		–	0
PK1SAT1		–	0
PK1SI		–	0
PK1SI1		–	0
PKSATIV		–	0
PKT1		–	0
PLII		–	0
PLPE0		–	0
PLPEB		–	0
PMEXP		–	0
PMEXPR		–	0
PNBODY		–	0
PNGATE		–	0
PNIGBACC		–	0
PNIGBINV		–	0
PNTGEN		–	0
PNTOX		–	0

Table 2-133. BSIM-CMG FINFET v107.0.0 Device Model Parameters

Parameter	Description	Units	Default
POXEDGE	Factor for the gate edge T_{ox}	–	1
PPCLM		–	0
PPCLMCV		–	0
PPCLMG		–	0
PPDIBL1		–	0
PPDIBL1R		–	0
PPDIBL2		–	0
PPGIDL		–	0
PPGISL		–	0
PPHIBE		–	0
PPHIG		–	0
PPHIN		–	0
PPIGCD		–	0
PPOXEDGE		–	0
PPRT		–	0
PPRWGD		–	0
PPRWGS		–	0
PPSAT		–	0
PPSATCV		–	0
PPTWG		–	0
PPTWGR		–	0
PPTWGT		–	0
PPVAG		–	0
PQM	Slope of normalized T_{cen} in inversion	–	0.66
PQMACC	Slope of normalized T_{cen} in accumulation	–	0.66
PQMFACTOR		–	0
PQMTCENCV		–	0
PQMTCENCVA		–	0
PQMTCENIV		–	0
PRDDR	Drain side quasi-saturation parameter	–	0
PRDSW		–	0
PRDW		–	0
PRSDEND		–	0
PRSDR	Source side quasi-saturation parameter	–	1
PRSW		–	0
PRT		–	0.001

Table 2-133. BSIM-CMG FINFET v107.0.0 Device Model Parameters

Parameter	Description	Units	Default
PRWGD	Gate bias dependence of drain extension resistance	V ⁻¹	0
PRWGS	Gate bias dependence of source extension resistance	V ⁻¹	0
PSAT	Velocity saturation exponent, after binnig should be from [2.0:inf)	-	2
PSATCV	Velocity saturation exponent for C-V	-	0
PSEJ	Source to substrate PN junction perimeter (BULKMOD=1)	-	0
PSEO	Perimeter of source to substrate overlap region through oxide	-	0
PSII0		-	0
PSII1		-	0
PSII2		-	0
PSIID		-	0
PSTHETASAT		-	0
PTGIDL		-	0
PTII		-	0
PTSS		-	0
PTWG	Gmsat degradation parameter - forward mode	-	0
PTWGR	Gmsat degradation parameter - reverse mode	-	0
PTWGT		-	0.004
PU0		-	0
PUA		-	0
PUA1		-	0
PUC		-	0
PUC1		-	0
PUCS		-	0
PUCSTE		-	0
PUD		-	0
PUD1		-	0
PUP		-	0
PUTE		-	0
PUTL		-	0
PVAG		-	1
PVSAT		-	0
PVSAT1		-	0
PVSAT1R		-	0
PVSATCV		-	0

Table 2-133. BSIM-CMG FINFET v107.0.0 Device Model Parameters

Parameter	Description	Units	Default
PWR		–	0
PXRCRG1		–	0
PXRCRG2		–	0
QM0	Knee-Point for Tcen in inversion (Charge normalized to Cox)	–	0.001
QM0ACC	Knee-Point for Tcen in accumulation (Charge normalized to Cox)	–	0.001
QMFACTOR	Prefactor + switch for QM Vth correction	–	0
QMTCENCV	Prefactor + switch for QM Width and Toxeff correction for CV	–	0
QMTCENCVA	Prefactor + switch for QM Width and Toxeff correction for CV (accumulation region)	–	0
QMTCENIV	Prefactor + switch for QM Width correction for IV	–	0
RDDR	Drain side drift resistance parameter - forward mode	–	0
RDDRR	Drain side drift resistance parameter - reverse mode	–	0
RDSMOD	Resistance model selector	–	0
RDSW		–	100
RDSWMIN		–	0
RDW		–	50
RDWMIN		–	0
RGATEMOD	Gate electrode resistor and ge node switcher — NOT USED IN XYCE	–	0
RGEOA	Fitting parameter for RGEOMOD=1	–	1
RGEOB	Fitting parameter for RGEOMOD=1	–	0
RGEOC	Fitting parameter for RGEOMOD=1	–	0
RGEOD	Fitting parameter for RGEOMOD=1	–	0
RGEOE	Fitting parameter for RGEOMOD=1	–	0
RGEOMOD	Bias independent parasitic resistance model selector	–	0
RGEXT	Effective gate electrode external resistance	–	0
RGFIN	Effective gate electrode per finger per fin resistance	–	0.001
RHOC		–	1e-12
RHORS		–	1
RSDR	Source side drift resistance parameter - forward mode	–	0
RSDRR	Source side drift resistance parameter - reverse mode	–	0
RSHD	Drain-side sheet resistance	–	0
RSHS	Source-side sheet resistance	–	0
RSW		–	50

Table 2-133. BSIM-CMG FINFET v107.0.0 Device Model Parameters

Parameter	Description	Units	Default
RSWMIN		–	0
RTH0	Thermal resistance	–	0.01
SDTERM		–	0
SHMOD	Self heating and T node switcher — NOT USED IN XYCE	–	0
SII0	Vgs dependent parameter of Iii	V ⁻¹	0.5
SII1	1st Vgs dependent parameter of Iii	V ⁻¹	0.1
SII2	2nd Vgs dependent parameter of Iii	–	0
SIID	3rd Vds dependent parameter of Iii	V ⁻¹	0
SJD	Constant for drain-side two-step second junction	–	0
SJS	Constant for source-side two-step second junction	–	0
SJSWD	Constant for drain-side sidewall two-step second junction	–	0
SJSWGD	Constant for source-side gate sidewall two-step second junction	–	0
SJSWGS	Constant for source-side gate sidewall two-step second junction	–	0
SJSWS	Constant for source-side sidewall two-step second junction	–	0
TBGASUB	Bandgap Temperature Coefficient (eV / degrees)	–	0.000702
TBGBSUB	Bandgap Temperature Coefficient (degrees)	–	1108
TCJ	Temperature coefficient for CJS/CJD	–	0
TCJSW	Temperature coefficient for CJSWS/CJSWD	–	0
TCJSWG	Temperature coefficient for CJSWGS/CJSWGD	–	0
TETA0	Temperature dependence of DIBL coefficient, 1/K	–	0
TETA0R	Temperature dependence of Reverse-mode DIBL coefficient, 1/K	–	0
TFIN	Body (Fin) thickness	–	1.5e-08
TGATE	Gate height on top of the hard mask	–	3e-08
TGIDL	GIDL/GISL Temperature Dependence	–	-0.003
III	Impact Ionization Temperature Dependence, IIMOD=2	–	0
TMASK	Height of hard mask on top of the fin	–	3e-08
TMEXP		–	0
TMEXPR		–	0
TNJTS	Temperature coefficient for NJTS	–	0
TNJTSD	Temperature coefficient for NJTSD	–	0
TNJTSSW	Temperature coefficient for NJTSSW	–	0

Table 2-133. BSIM-CMG FINFET v107.0.0 Device Model Parameters

Parameter	Description	Units	Default
TNJTSSWD	NTemperature coefficient for NJTSSWD	–	0
TNJTSSWG	Temperature coefficient for NJTSSWG	–	0
TNJTSSWGD	Temperature coefficient for NJTSSWGD	–	0
TNOM	Temperature at which the model is extracted (degrees)	–	27
TOXG	oxide thickness for gate current model in meters, Introduced in BSIM-CMG106.1.0	m	0
TOXP	physical oxide thickness in meters	–	1.2e-09
TOXREF	Target tox value [m]	–	1.2e-09
TPB	Temperature coefficient for PBS/PBD	–	0
TPBSW	Temperature coefficient for PBSWS/PBSWD	–	0
TPBSWG	Temperature coefficient for PBSWGS/PBSWGD	–	0
TRDDR		–	0
TRSDR		–	0
TSILI	Thickness of the silicide on top of the raised source/drain	–	1e-08
TSS	SSwing Temperature Coefficient (/ degrees)	–	0
U0		–	0.03
U0MULT	Variability in carrier mobility	–	1
U0N1	NFIN dependence of U0	–	0
U0N2	NFIN dependence of U0	–	100000
UA		–	0.3
UA1		–	0.001032
UC	Body effect for mobility degradation parameter - BULKMOD=1	–	0
UC1		–	5.6e-11
UCS		–	1
UCSTE		–	-0.004775
UD		–	0
UD1		–	0
UP		–	0
UTE		–	0
UTL		–	-0.0015
VSAT		–	85000
VSAT1	Velocity Saturation parameter for I_on degradation - forward mode	–	0
VSAT1N1	NFIN dependence of VSAT1	–	0
VSAT1N2	NFIN dependence of VSAT1	–	0

Table 2-133. BSIM-CMG FINFET v107.0.0 Device Model Parameters

Parameter	Description	Units	Default
VSAT1R	Velocity Saturation parameter for I _{on} degradation - reverse mode	–	0
VSAT1RN1	NFIN dependence of VSAT1R	–	0
VSAT1RN2	NFIN dependence of VSAT1R	–	0
VSATCV	Velocity Saturation parameter for CV	–	0
VSATN1	NFIN dependence of VSAT	–	0
VSATN2	NFIN dependence of VSAT	–	100000
VTSD	Bottom drain junction trap-assisted current voltage dependent parameter	–	0
VTSS	Bottom source junction trap-assisted current voltage dependent parameter	–	10
VTSSWD	Unit length trap-assisted current voltage dependent parameter for sidewall drain junction	–	0
VTSSWGD	Unit length trap-assisted current voltage dependent parameter for gate-edge sidewall drain junction	–	0
VTSSWGS	Unit length trap-assisted current voltage dependent parameter for gate-edge sidewall source junction	–	10
VTSSWS	Unit length trap-assisted current voltage dependent parameter for sidewall source junction	–	10
WR		–	1
WTH0	Width dependence coefficient for R _{th} and C _{th}	–	0
XJBVD	Fitting parameter for drain diode breakdown current	–	0
XJBVS	Fitting parameter for source diode breakdown current	–	1
XL	L offset for channel length due to mask/etch effect	–	0
XRCRG1		–	12
XRCRG2		–	1
XTID	Drain junction current temperature exponent	–	0
XTIS	Source junction current temperature exponent	–	3
XTSD	Power dependence of JTSD on temperature	–	0
XTSS	Power dependence of JTSS on temperature	–	0.02
XTSSWD	Power dependence of JTSSWD on temperature	–	0
XTSSWGD	Power dependence of JTSSWGD on temperature	–	0
XTSSWGS	Power dependence of JTSSWGS on temperature	–	0.02
XTSSWS	Power dependence of JTSSWS on temperature	–	0.02

Table 2-134. MOSFET level 107 Output Variables

Parameter	Description	Units	Default
WEFF	WEFF	–	none
LEFF	LEFF	–	none
WEFFCV	WEFFCV	–	none
LEFFCV	LEFFCV	–	none
IDS	IDS	–	none
IDEFF	IDEFF	–	none
ISEFF	ISEFF	–	none
IGTOT	IGTOT	–	none
IDSGEN	IDSGEN	–	none
III	III	–	none
IGIDL	IGIDL	–	none
IGISL	IGISL	–	none
IJSB	IJSB	–	none
IJDB	IJDB	–	none
ISUB	ISUB	–	none
BETA	BETA	–	none
VTH	VTH	–	none
VDSSAT	VDSSAT	–	none
VFB	VFB	–	none
GM	GM	–	none
GDS	GDS	–	none
GMBS	GMBS	–	none
QGI	QGI	–	none
QDI	QDI	–	none
QSI	QSI	–	none
QBI	QBI	–	none
QG	QG	–	none
QD	QD	–	none
QS	QS	–	none
QB	QB	–	none
CGGI	CGGI	–	none
CGSI	CGSI	–	none
CGDI	CGDI	–	none
CGEI	CGEI	–	none
CDGI	CDGI	–	none
CDDI	CDDI	–	none

Table 2-134. MOSFET level 107 Output Variables

Parameter	Description	Units	Default
CDSI	CDSI	–	none
CDEI	CDEI	–	none
CSGI	CSGI	–	none
CSDI	CSDI	–	none
CSSI	CSSI	–	none
CSEI	CSEI	–	none
CEGI	CEGI	–	none
CEDI	CEDI	–	none
CESI	CESI	–	none
CEEI	CEEI	–	none
CGG	CGG	–	none
CGS	CGS	–	none
CGD	CGD	–	none
CGE	CGE	–	none
CDG	CDG	–	none
CDD	CDD	–	none
CDS	CDS	–	none
CDE	CDE	–	none
CSG	CSG	–	none
CSD	CSD	–	none
CSS	CSS	–	none
CSE	CSE	–	none
CEG	CEG	–	none
CED	CED	–	none
CES	CES	–	none
CEE	CEE	–	none
CGSEXT	CGSEXT	–	none
CGDEXT	CGDEXT	–	none
CGBOV	CGBOV	–	none
CJST	CJST	–	none
CJDT	CJDT	–	none
RSGEO	RSGEO	–	none
RDGEO	RDGEO	–	none
CFGEO	CFGEO	–	none

Table 2-135. BSIM-CMG FINFET v108.0.0 Device Instance Parameters

Parameter	Description	Units	Default
ADEJ	Drain junction area (BULKMOD=1)	–	0
ADEO	Drain to substrate overlap area through oxide	–	0
ASEJ	Source junction area (BULKMOD=1)	–	0
ASEO	Source to substrate overlap area through oxide	–	0
CDSP	Constant drain-to-source fringe capacitance (All CGEOMOD)	–	0
CGDP	Constant gate-to-drain fringe capacitance (CGEOMOD=1)	–	0
CGSP	Constant gate-to-source fringe capacitance (CGEOMOD=1)	–	0
COVD	Constant g/d overlap capacitance (CGEOMOD=1)	–	0
COVS	Constant g/s overlap capacitance (CGEOMOD=1)	–	0
D	Diameter of the cylinder (GEOMOD=3)	–	4e-08
FPITCH	Fin pitch	–	8e-08
L	Designed Gate Length	–	3e-08
LRSD	Length of the source/drain	–	0
M	multiplicity factor	—	1
NF	Number of fingers	–	1
NFIN	Number of fins per finger (real number enables optimization)	–	1
NGCON	number of gate contact (1 or 2 sided)	–	1
NRD	Number of source diffusion squares	–	0
NRS	Number of source diffusion squares	–	0
PDEJ	Drain to substrate PN junction perimeter (BULKMOD=1)	–	0
PDEO	Perimeter of drain to substrate overlap region through oxide	–	0
PSEJ	Source to substrate PN junction perimeter (BULKMOD=1)	–	0
PSEO	Perimeter of source to substrate overlap region through oxide	–	0
TFIN	Body (Fin) thickness	–	1.5e-08

Table 2-136. BSIM-CMG FINFET v108.0.0 Device Model Parameters

Parameter	Description	Units	Default
A1	Non-saturation effect parameter for strong inversion region	–	0

Table 2-136. BSIM-CMG FINFET v108.0.0 Device Model Parameters

Parameter	Description	Units	Default
A11	Temperature dependence of A1	–	0
A2	Non-saturation effect parameter for moderate inversion region	–	0
A21	Temperature dependence of A2	–	0
ADEJ	Drain junction area (BULKMOD=1)	–	0
ADEO	Drain to substrate overlap area through oxide	–	0
AEU		–	0
AEUR		–	0
AGIDL	pre-exponential coeff. for GIDL in mho	–	0
AGISL	pre-exponential coeff. for GISL in mho	–	6.055e-12
AIGBACC	parameter for Igb in accumulation	–	0.0136
AIGBACC1	parameter for Igb in accumulation	–	0
AIGBINV	parameter for Igb in inversion	–	0.0111
AIGBINV1	parameter for Igb in inversion	–	0
AIGC	parameter for Igc in inversion	–	0.0136
AIGC1	parameter for Igc in inversion	–	0
AIGD	parameter for Igd in inversion	–	0
AIGD1	parameter for Igd in inversion	–	0
AIGEN	Thermal Generation Current Parameter	–	0
AIGS	parameter for Igs in inversion	–	0.0136
AIGS1	parameter for Igs in inversion	–	0
ALPHA0	first parameter of Iii, m/V	–	0
ALPHA01	Temperature dependence of ALPHA0, m/V/degrees	–	0
ALPHA1	L scaling parameter of Iii, 1/V	–	0
ALPHA11	Temperature dependence ALPHA1, 1/V/degree	–	0
ALPHAI0	first parameter of Iii for IIMOD=2, m/V	–	0
ALPHAI01	Temperature dependence of ALPHAI0, m/V/degrees	–	0
ALPHAI1	L scaling parameter of Iii for IIMOD=2, 1/V	–	0
ALPHAI11	Temperature dependence of ALPHAI1, 1/V/degrees	–	0
AMEXP		–	0
AMEXPR		–	0
APCLM		–	0
APCLMR		–	0
APSAT		–	0
APSATCV		–	0
APTWG		–	0

Table 2-136. BSIM-CMG FINFET v108.0.0 Device Model Parameters

Parameter	Description	Units	Default
AQMTCEN	Parameter for Geometric dependence of Tcen on R/TFIN/HFIN	–	0
ARDSW		–	0
ARDW		–	0
ARSDEND		–	0
ARSW		–	0
ASEJ	Source junction area (BULKMOD=1)	–	0
ASEO	Source to substrate overlap area through oxide	–	0
ASILIEND		–	0
ASYMMOD	Asymmetric model selector	–	0
AT		–	-0.00156
ATCV		–	0
ATR		–	0
AUA		–	0
AUAR		–	0
AUD		–	0
AUDR		–	0
AVSAT		–	0
AVSAT1		–	0
AVSATCV		–	0
BETA0	Vds dependent parameter of Iii, 1/V	–	0
BETA10	Vds dependent parameter of Iii, 1/V	–	0
BETA11	Vds dependent parameter of Iii	–	0
BETA12	Vds dependent parameter of Iii, V	–	0.1
BEU		–	1e-07
BEUR		–	0
BG0SUB	Band gap of substrate at 300.15K, eV	–	1.12
BGIDL	exponential coeff. for GIDL in V/m	–	0
BGISL	exponential coeff. for GISL in V/m	–	3e+08
BIGBACC	parameter for Igb in accumulation	–	0.00171
BIGBINV	parameter for Igb in inversion	–	0.000949
BIGC	parameter for Igc in inversion	–	0.00171
BIGD	parameter for Igd in inversion	–	0
BIGEN	Thermal Generation Current Parameter	–	0
BIGS	parameter for Igs in inversion	–	0.00171
BMEXP		–	1

Table 2-136. BSIM-CMG FINFET v108.0.0 Device Model Parameters

Parameter	Description	Units	Default
BMEXPR		–	0
BPCLM		–	1e-07
BPCLMR		–	0
BPSAT		–	1
BPSATCV		–	0
BPTWG		–	1e-07
BQMTCEN	Parameter for Geometric dependence of Tcen on R/TFIN/HFIN	–	1.2e-08
BRDSW		–	1e-07
BRDW		–	1e-07
BRSW		–	1e-07
BUA		–	1e-07
BUAR		–	0
BUD		–	5e-08
BUDR		–	0
BULKMOD	Bulk model	–	0
BVD	Drain diode breakdown voltage	–	0
BVS	Source diode breakdown voltage	–	10
BVSAT		–	1e-07
BVSAT1		–	0
BVSATCV		–	0
CAPMOD	Accumulation capacitance selector	–	0
CDSC	coupling capacitance between S/D and channel	–	0.007
CDSCD	drain-bias sensitivity of CDSC	–	0.007
CDSCDN1	NFIN dependence of CDSCD	–	0
CDSCDN2	NFIN dependence of CDSCD	–	100000
CDSCDR	Reverse-mode drain-bias sensitivity of CDSC (Experimental)	–	0
CDSCDRN1	NFIN dependence of CDSCD	–	0
CDSCDRN2	NFIN dependence of CDSCD	–	0
CDSCN1	NFIN dependence of CDSC	–	0
CDSCN2	NFIN dependence of CDSC	–	100000
CDSP	Constant drain-to-source fringe capacitance (All CGEOMOD)	–	0
CFD	Outer Fringe Cap (drain side)	–	0
CFS	Outer Fringe Cap (source side)	–	2.5e-11

Table 2-136. BSIM-CMG FINFET v108.0.0 Device Model Parameters

Parameter	Description	Units	Default
CGBL	Bias dependent component of Gate to substrate overlap cap per unit channel length per fin per finger	–	0
CGBN	Gate to substrate overlap cap per unit channel length per fin per finger	–	0
CGBO	Gate to substrate overlap cap per unit channel length per finger per NGCON	–	0
CGDL		–	0
CGDO	Non LDD region drain-gate overlap capacitance per unit channel width	–	0
CGDP	Constant gate-to-drain fringe capacitance (CGEOMOD=1)	–	0
CGEO1SW		–	0
CGEOA	Fitting parameter for CGEOMOD=2	–	1
CGEOB	Fitting parameter for CGEOMOD=2	–	0
CGEOC	Fitting parameter for CGEOMOD=2	–	0
CGEOD	Fitting parameter for CGEOMOD=2	–	0
CGEOE	Fitting parameter for CGEOMOD=2	–	1
CGEOMOD	Geometry dependent parasitic capacitance model selector	–	0
CGIDL	parameter for body-effect of GIDL in V**3	–	0
CGISL	parameter for body-effect of GISL in V**3	–	0.5
CGSL		–	0
CGSO	Non LDD region source-gate overlap capacitance per unit channel width	–	0
CGSP	Constant gate-to-source fringe capacitance (CGEOMOD=1)	–	0
CHARGEWF	Average Channel Charge Weighting Factor, +1:source-side, 0:middle, -1:drain-side	–	0
CIGBACC	parameter for Igb in accumulation	–	0.075
CIGBINV	parameter for Igb in inversion	–	0.006
CIGC	parameter for Igc in inversion	–	0.075
CIGD	parameter for Igd in inversion	–	0
CIGS	parameter for Igs in inversion	–	0.075
CIT	parameter for interface trap	–	0
CITR	parameter for interface trap in reverse mode for asymmetric model	–	0
CJD	Unit area drain-side junction capacitance at zero bias	–	0
CJS	Unit area source-side junction capacitance at zero bias	–	0.0005

Table 2-136. BSIM-CMG FINFET v108.0.0 Device Model Parameters

Parameter	Description	Units	Default
CJSWD	Unit length drain-side sidewall junction capacitance at zero bias	–	0
CJSWGD	Unit length drain-side gate sidewall junction capacitance at zero bias	–	0
CJSWGS	Unit length source-side gate sidewall junction capacitance at zero bias	–	0
CJSWS	Unit length source-side sidewall junction capacitance at zero bias	–	5e-10
CKAPPAB		–	0.6
CKAPPAD		–	0
CKAPPAS		–	0.6
COREMOD	Surface potential algorithm	–	0
COVD	Constant g/d overlap capacitance (CGEOMOD=1)	–	0
COVS	Constant g/s overlap capacitance (CGEOMOD=1)	–	0
CRATIO		–	0.5
CSDESW	Coefficient for source/drain to substrate sidewall cap	–	0
CTH0	Thermal capacitance	–	1e-05
D	Diameter of the cylinder (GEOMOD=3)	–	4e-08
DELTAPRSD		–	0
DELTAVSAT		–	1
DELTAVSATCV		–	0
DELTAW	change of effective width due to shape of fin/cylinder	–	0
DELTAWCV	CV change of effective width due to shape of fin/cylinder	–	0
DELVFBACC	Change in Flatband Voltage; Vfb_accumulation-Vfb_inversion	–	0
DELVTRAND	Variability in Vth	–	0
DEVTYPE		–	1
DLBIN	Delta L for Binning	–	0
DLC	Delta L for C-V model	–	0
DLCACC	Delta L for C-V model in accumulation region (CAPMOD=1, BULKMOD=1)	–	0
DLCIGD	Delta L for Igd model	–	0
DLCIGS	Delta L for Igs model	–	0
DROUT		–	1.06
DSUB	DIBL exponent coefficient	–	1.06
DTEMP	Variability in Device Temperature	–	0
DVT0	SCE coefficient	–	0

Table 2-136. BSIM-CMG FINFET v108.0.0 Device Model Parameters

Parameter	Description	Units	Default
DVT1	SCE exponent coefficient, after binning should be in (0:inf)	–	0.6
DVT1SS	Subthreshold Swing exponent coefficient, after binning should be in (0:inf)	–	0
DVTP0	Coefficient for Drain-Induced Vth Shift (DITS)	–	0
DVTP1	DITS exponent coefficient	–	0
DVTSHIFT	Vth shift handle	–	0
DVTSHIFTR	Vth shift handle for asymmetric mode	–	0
EASUB	Electron affinity of substrate, eV	–	4.05
EF	Flicker Noise frequency exponent	–	1
EGIDL	band bending parameter for GIDL in V	–	0
EGISL	band bending parameter for GISL in V	–	0.2
EIGBINV	parameter for Igb in inversion	–	1.1
EM		–	4.1e+07
EMOBT		–	0
EOT	equivalent oxide thickness in meters	–	1e-09
EOTACC	equivalent oxide thickness for accumulation region in meters	–	0
EOTBOX	equivalent oxide thickness of the buried oxide (SOI FinFET) or STI (bulk FinFET) in meters	–	1.4e-07
EPSROX	Relative dielectric constant of the gate dielectric	–	3.9
EPSRSP	Relative dielectric constant of the spacer	–	3.9
EPSRSUB	Relative dielectric constant of the channel material	–	11.9
ESATII	Saturation channel E-Field for Iii, V/m	–	1e+07
ETA0	DIBL coefficient	–	0.6
ETA0N1	NFIN dependence of ETA0	–	0
ETA0N2	NFIN dependence of ETA0	–	100000
ETA0R	Reverse-mode DIBL coefficient (Experimental)	–	0
ETAMOB		–	2
ETAQM	Bulk charge coefficient for Tcen	–	0.54
EU		–	2.5
EUR		–	0
FECH	End-channel factor, for different orientation/shape	–	1
FECHCV	CV end-channel factor, for different orientation/shape	–	1
FPITCH	Fin pitch	–	8e-08
GEOMOD	Geometry mode selector	–	1
GIDLMOD	GIDL/GISL current switcher	–	0

Table 2-136. BSIM-CMG FINFET v108.0.0 Device Model Parameters

Parameter	Description	Units	Default
HEPI	Height of the raised source/drain on top of the fin	–	1e-08
HFIN	Fin height in meters	–	3e-08
IDS0MULT	Variability in Drain current for misc. reasons	–	1
IGBMOD	Model selector for Igb	–	0
IGCMOD	Model selector for Igc, Igs, and Igd	–	0
IGT	Gate Current Temperature Dependence	–	2.5
IIMOD	Impact ionization model switch	–	0
IIT	Impact Ionization Temperature Dependence, IIMOD=1	–	-0.5
IJTHDFWD	Forward drain diode breakdown limiting current	–	0
IJTHDREV	Reverse drain diode breakdown limiting current	–	0
IJTHSFWD	Forward source diode breakdown limiting current	–	0.1
IJTHSREV	Reverse source diode breakdown limiting current	–	0.1
IMIN	Parameter for Vgs Clamping for inversion region calc. in accumulation	–	1e-15
JSD	Bottom drain junction reverse saturation current density	–	0
JSS	Bottom source junction reverse saturation current density	–	0.0001
JSWD	Unit length reverse saturation current for sidewall drain junction	–	0
JSWGD	Unit length reverse saturation current for gate-edge sidewall drain junction	–	0
JSWGS	Unit length reverse saturation current for gate-edge sidewall source junction	–	0
JSWS	Unit length reverse saturation current for sidewall source junction	–	0
JTSD	Bottom drain junction trap-assisted saturation current density	–	0
JTSS	Bottom source junction trap-assisted saturation current density	–	0
JTSSWD	Unit length trap-assisted saturation current for sidewall drain junction	–	0
JTSSWGD	Unit length trap-assisted saturation current for gate-edge sidewall drain junction	–	0
JTSSWGS	Unit length trap-assisted saturation current for gate-edge sidewall source junction	–	0
JTSSWS	Unit length trap-assisted saturation current for sidewall source junction	–	0
JTWEFF	Trap assisted tunneling current width dependence	–	0

Table 2-136. BSIM-CMG FINFET v108.0.0 Device Model Parameters

Parameter	Description	Units	Default
K0	Lateral NUD voltage parameter, V	–	0
K01	Temperature dependence of lateral NUD voltage parameter, V/K	–	0
K0SI	Correction factor for strong inversion, used in Mnud, after binnig should be from (0:inf)	–	1
K0SI1	Temperature dependence of K0SI, 1/K	–	0
K1	Body effect coefficient for sub-threshold region	–	0
K11	Temperature dependence of K1	–	0
K1RSCE	K1 for reverse short channel effect calculation	–	0
K1SAT	Correction factor for K1 in saturation (high Vds)	–	0
K1SAT1	Temperature dependence of K1SAT1	–	0
K1SI	Correction factor for strong inversion, used in Mob	–	0
K1SI1	Temperature dependence of K1SI, 1/K	–	0
KSATIV		–	1
KSATIVR	KSATIV in asymmetric mode	–	0
KT1	Vth Temperature Coefficient (V)	–	0
KT1L	Vth Temperature L Coefficient (m-V)	–	0
L	Designed Gate Length	–	3e-08
LA1		–	0
LA11		–	0
LA2		–	0
LA21		–	0
LAGIDL		–	0
LAGISL		–	0
LAIGBACC		–	0
LAIGBACC1		–	0
LAIGBINV		–	0
LAIGBINV1		–	0
LAIGC		–	0
LAIGC1		–	0
LAIGD		–	0
LAIGD1		–	0
LAIGEN		–	0
LAIGS		–	0
LAIGS1		–	0
LALPHA0		–	0

Table 2-136. BSIM-CMG FINFET v108.0.0 Device Model Parameters

Parameter	Description	Units	Default
LALPHA1		–	0
LALPHAI10		–	0
LALPHAI11		–	0
LAT		–	0
LATCV		–	0
LATR		–	0
LBETA0		–	0
LBETAI10		–	0
LBETAI11		–	0
LBETAI12		–	0
LBGIDL		–	0
LBGISL		–	0
LBIGBACC		–	0
LBIGBINV		–	0
LBIGC		–	0
LBIGD		–	0
LBIGEN		–	0
LBIGS		–	0
LCDSC		–	0
LCDSCL		–	0
LCDSCLR		–	0
LCFD		–	0
LCFS		–	0
LCGBL		–	0
LCGDL		–	0
LCGIDL		–	0
LCGISL		–	0
LCGSL		–	0
LCIGBACC		–	0
LCIGBINV		–	0
LCIGC		–	0
LCIGD		–	0
LCIGS		–	0
LCIT		–	0
LCITR		–	0
LCKAPPAB		–	0

Table 2-136. BSIM-CMG FINFET v108.0.0 Device Model Parameters

Parameter	Description	Units	Default
LCKAPPAD		–	0
LCKAPPAS		–	0
LCOVD		–	0
LCOVS		–	0
LDELTAVSAT		–	0
LDELTAVSATCV		–	0
LDROUT		–	0
LDSUB		–	0
LDVT0		–	0
LDVT1		–	0
LDVT1SS		–	0
LDVTB		–	0
LDVTSHIFT		–	0
LDVTSHIFTR		–	0
LEGIDL		–	0
LEGISL		–	0
LEIGBINV		–	0
LEMOBT		–	0
LESATII		–	0
LETA0		–	0
LETA0R		–	0
LETAMOB		–	0
LEU		–	0
LEUR		–	0
LIGT		–	0
LII	Channel length dependent parameter of Iii, V-m	–	5e-10
LIIT		–	0
LINT	Length reduction parameter (dopant diffusion effect)	–	0
LINTIGEN	Lint for Thermal Generation Current	–	0
LINTNOI		–	0
LK0		–	0
LK01		–	0
LK0SI		–	0
LK0SI1		–	0
LK1		–	0
LK11		–	0

Table 2-136. BSIM-CMG FINFET v108.0.0 Device Model Parameters

Parameter	Description	Units	Default
LK1RSCE		–	0
LK1SAT		–	0
LK1SAT1		–	0
LK1SI		–	0
LK1SI1		–	0
LKSATIV		–	0
LKSATIVR		–	0
LKT1		–	0
LL	Length reduction parameter (dopant diffusion effect)	–	0
LLC	Length reduction parameter (dopant diffusion effect)	–	0
LLII		–	0
LLN	Length reduction parameter (dopant diffusion effect)	–	1
LLPE0		–	0
LLPEB		–	0
LMAX	Maximum length for which this model should be used.	–	100
LMEXP		–	0
LMEXPR		–	0
LMIN	Minimum length for which this model should be used.	–	0
LNBODY		–	0
LNGATE		–	0
LNIGBACC		–	0
LNIGBINV		–	0
LNTGEN		–	0
LNTOX		–	0
LPA		–	1
LPAR		–	0
LPCLM		–	0
LPCLMCV		–	0
LPCLMG		–	0
LPCLMR		–	0
LPDIBL1		–	0
LPDIBL1R		–	0
LPDIBL2		–	0
LPDIBL2R		–	0
LPE0	Equivalent length of pocket region at zero bias	–	5e-09
LPGIDL		–	0

Table 2-136. BSIM-CMG FINFET v108.0.0 Device Model Parameters

Parameter	Description	Units	Default
LPGISL		–	0
LPHIBE		–	0
LPHIG		–	0
LPHIN		–	0
LPIGCD		–	0
LPOXEDGE		–	0
LPRT		–	0
LPRWGD		–	0
LPRWGS		–	0
LPSAT		–	0
LPSATCV		–	0
LPTWG		–	0
LPTWGR		–	0
LPTWGT		–	0
LPVAG		–	0
LQMFACOR		–	0
LQMCENCV		–	0
LQMCENCVA		–	0
LQMCENIV		–	0
LRDSW		–	0
LRDW		–	0
LRSD	Length of the source/drain	–	0
LRSW		–	0
LSII0		–	0
LSII1		–	0
LSII2		–	0
LSIID		–	0
LSP		–	0
LSTTHETASAT		–	0
LTGIDL		–	0
LTII		–	0
LTSS		–	0
LU0		–	0
LU0R		–	0
LUA		–	0
LUA1		–	0

Table 2-136. BSIM-CMG FINFET v108.0.0 Device Model Parameters

Parameter	Description	Units	Default
LUA1R		–	0
LUAR		–	0
LUC		–	0
LUC1		–	0
LUC1R		–	0
LUCR		–	0
LUCS		–	0
LUCSTE		–	0
LUD		–	0
LUD1		–	0
LUD1R		–	0
LUDR		–	0
LUP		–	0
LUTE		–	0
LUTER		–	0
LUTL		–	0
LUTLR		–	0
LVSAT		–	0
LVSAT1		–	0
LVSAT1R		–	0
LVSATCV		–	0
LVSATR		–	0
LWR		–	0
LXRCRG1		–	0
LXRCRG2		–	0
MEXP		–	4
MEXPR		–	0
MJD	Drain bottom junction capacitance grading coefficient	–	0
MJD2	Drain bottom two-step second junction capacitance grading coefficient	–	0
MJS	Source bottom junction capacitance grading coefficient	–	0.5
MJS2	Source bottom two-step second junction capacitance grading coefficient	–	0.125
MJSWD	Drain sidewall junction capacitance grading coefficient	–	0

Table 2-136. BSIM-CMG FINFET v108.0.0 Device Model Parameters

Parameter	Description	Units	Default
MJSWD2	Drain sidewall two-step second junction capacitance grading coefficient	–	0
MJSWGD	Drain-side gate sidewall junction capacitance grading coefficient	–	0
MJSWGD2	Drain-side gate sidewall two-step second junction capacitance grading coefficient	–	0
MJSWGS	Source-side gate sidewall junction capacitance grading coefficient	–	0
MJSWGS2	Source-side gate sidewall two-step second junction capacitance grading coefficient	–	0
MJSWS	Source sidewall junction capacitance grading coefficient	–	0.33
MJSWS2	Source sidewall two-step second junction capacitance grading coefficient	–	0.083
NA1		–	0
NA11		–	0
NA2		–	0
NA21		–	0
NAGIDL		–	0
NAGISL		–	0
NAIGBACC		–	0
NAIGBACC1		–	0
NAIGBINV		–	0
NAIGBINV1		–	0
NAIGC		–	0
NAIGC1		–	0
NAIGD		–	0
NAIGD1		–	0
NAIGEN		–	0
NAIGS		–	0
NAIGS1		–	0
NALPHA0		–	0
NALPHA1		–	0
NALPHAI0		–	0
NALPHAI1		–	0
NAT		–	0
NATCV		–	0
NATR		–	0

Table 2-136. BSIM-CMG FINFET v108.0.0 Device Model Parameters

Parameter	Description	Units	Default
NBETA0		–	0
NBETAI0		–	0
NBETAI1		–	0
NBETAI2		–	0
NBGIDL		–	0
NBGISL		–	0
NBIGBACC		–	0
NBIGBINV		–	0
NBIGC		–	0
NBIGD		–	0
NBIGEN		–	0
NBIGS		–	0
NBODY	channel (body) doping	–	1e+22
NBODYN1	NFIN dependence of channel (body) doping	–	0
NBODYN2	NFIN dependence of channel (body) doping	–	100000
NC0SUB	Conduction band density of states, m-3	–	2.86e+25
NCDSC		–	0
NCDSCD		–	0
NCDSCDR		–	0
NCFD		–	0
NCFS		–	0
NCGBL		–	0
NCGDL		–	0
NCGIDL		–	0
NCGISL		–	0
NCGSL		–	0
NCIGBACC		–	0
NCIGBINV		–	0
NCIGC		–	0
NCIGD		–	0
NCIGS		–	0
NCIT		–	0
NCITR		–	0
NCKAPPAB		–	0
NCKAPPAD		–	0
NCKAPPAS		–	0

Table 2-136. BSIM-CMG FINFET v108.0.0 Device Model Parameters

Parameter	Description	Units	Default
NCOVD		–	0
NCOVS		–	0
NDELTAVSAT		–	0
NDELTAVSATCV		–	0
NDROUT		–	0
NDSUB		–	0
NDVT0		–	0
NDVT1		–	0
NDVT1SS		–	0
NDVTB		–	0
NDVTSHIFT		–	0
NDVTSHIFTR		–	0
NEGIDL		–	0
NEGISL		–	0
NEIGBINV		–	0
NEMOBT		–	0
NESATII		–	0
NETA0		–	0
NETA0R		–	0
NETAMOB		–	0
NEU		–	0
NEUR		–	0
NF	Number of fingers	–	1
NFIN	Number of fins per finger (real number enables optimization)	–	1
NFINMAX	Maximum NFIN for which this model should be used.	–	100
NFINMIN	Minimum NFIN for which this model should be used.	–	0
NGATE	Parameter for Poly Gate Doping, for metal gate please set NGATE = 0	–	0
NGCON	number of gate contact (1 or 2 sided)	–	1
NI0SUB	Intrinsic carrier constant at 300.15K, m-3	–	1.1e+16
NIGBACC	parameter for Igb in accumulation	–	1
NIGBINV	parameter for Igb in inversion	–	3
NIGT		–	0
NIIT		–	0
NJD	Drain junction emission coefficient	–	0

Table 2-136. BSIM-CMG FINFET v108.0.0 Device Model Parameters

Parameter	Description	Units	Default
NJS	Source junction emission coefficient	–	1
NJTS	Non-ideality factor for JTSS	–	20
NJTSD	Non-ideality factor for JTSD	–	0
NJTSSW	Non-ideality factor for JTSSWS	–	20
NJTSSWD	Non-ideality factor for JTSSWD	–	0
NJTSSWG	Non-ideality factor for JTSSWGS	–	20
NJTSSWGD	Non-ideality factor for JTSSWGD	–	0
NK0		–	0
NK01		–	0
NK0SI		–	0
NK0SI1		–	0
NK1		–	0
NK11		–	0
NK1RSCE		–	0
NK1SAT		–	0
NK1SAT1		–	0
NK1SI		–	0
NK1SI1		–	0
NKSATIV		–	0
NKSATIVR		–	0
NKT1		–	0
NLII		–	0
NLPE0		–	0
NLPEB		–	0
NMEXP		–	0
NMEXPR		–	0
NNBODY		–	0
NNGATE		–	0
NNIGBACC		–	0
NNIGBINV		–	0
NNTGEN		–	0
NNTOX		–	0
NOIA		–	6.25e+39
NOIB		–	3.125e+24
NOIC		–	8.75e+07
NPCLM		–	0

Table 2-136. BSIM-CMG FINFET v108.0.0 Device Model Parameters

Parameter	Description	Units	Default
NPCLMCV		–	0
NPCLMG		–	0
NPCLMR		–	0
NPDI BL1		–	0
NPDI BL1R		–	0
NPDI BL2		–	0
NPDI BL2R		–	0
NP GIDL		–	0
NP GISL		–	0
NPHIBE		–	0
NPHIG		–	0
NPHIN		–	0
NPI GCD		–	0
NPOXEDGE		–	0
NPRT		–	0
NPRWGD		–	0
NPRWGS		–	0
NPSAT		–	0
NPSATCV		–	0
NPTWG		–	0
NPTWGR		–	0
NPTWGT		–	0
NPVAG		–	0
NQMFAC TOR		–	0
NQMT CENC V		–	0
NQMT CENC VA		–	0
NQMT CENC IV		–	0
NQSMOD		–	0
NRD	Number of source diffusion squares	–	0
NRDSW		–	0
NRDW		–	0
NRS	Number of source diffusion squares	–	0
NRSW		–	0
NSD	Source/drain active doping concentration in m-3	–	2e+26
NSDE	Source/drain active doping concentration at Leff edge	–	2e+25

Table 2-136. BSIM-CMG FINFET v108.0.0 Device Model Parameters

Parameter	Description	Units	Default
NSEG	Number of segments for NQSMOD=3 (3,5 and 10 supported)	–	4
NSII0		–	0
NSII1		–	0
NSII2		–	0
NSIID		–	0
NSTHETASAT		–	0
NTGEN	Thermal Generation Current Parameter	–	1
NTGIDL		–	0
NTII		–	0
NTNOI		–	1
NTOX	Exponent for Tox ratio	–	1
NTSS		–	0
NU0		–	0
NU0R		–	0
NUA		–	0
NUA1		–	0
NUA1R		–	0
NUAR		–	0
NUC		–	0
NUC1		–	0
NUC1R		–	0
NUCR		–	0
NUCS		–	0
NUCSTE		–	0
NUD		–	0
NUD1		–	0
NUD1R		–	0
NUDR		–	0
NUP		–	0
NUTE		–	0
NUTER		–	0
NUTL		–	0
NUTLR		–	0
NVSAT		–	0
NVSAT1		–	0

Table 2-136. BSIM-CMG FINFET v108.0.0 Device Model Parameters

Parameter	Description	Units	Default
NVSAT1R		–	0
NVSATCV		–	0
NVSATR		–	0
NVTM	Subthreshold Swing factor multiplied by V_{tm} . If defined by user, will overwrite nV_{tm} in the code	–	0
NWR		–	0
NXRCRG1		–	0
NXRCRG2		–	0
PA1		–	0
PA11		–	0
PA2		–	0
PA21		–	0
PAGIDL		–	0
PAGISL		–	0
PAIGBACC		–	0
PAIGBACC1		–	0
PAIGBINV		–	0
PAIGBINV1		–	0
PAIGC		–	0
PAIGC1		–	0
PAIGD		–	0
PAIGD1		–	0
PAIGEN		–	0
PAIGS		–	0
PAIGS1		–	0
PALPHA0		–	0
PALPHA1		–	0
PALPHAI0		–	0
PALPHAI1		–	0
PAT		–	0
PATCV		–	0
PATR		–	0
PBD	Drain-side bulk junction built-in potential	–	0
PBETA0		–	0
PBETAI0		–	0
PBETAI1		–	0

Table 2-136. BSIM-CMG FINFET v108.0.0 Device Model Parameters

Parameter	Description	Units	Default
PBETAI12		–	0
PBGIDL		–	0
PBGISL		–	0
PBIGBACC		–	0
PBIGBINV		–	0
PBIGC		–	0
PBIGD		–	0
PBIGEN		–	0
PBIGS		–	0
PBS	Source-side bulk junction built-in potential	–	1
PBSWD	Built-in potential for Drain-side sidewall junction capacitance	–	0
PBSWGD	Built-in potential for Drain-side gate sidewall junction capacitance	–	0
PBSWGS	Built-in potential for Source-side gate sidewall junction capacitance	–	0
PBSWS	Built-in potential for Source-side sidewall junction capacitance	–	1
PCDSC		–	0
PCDSCD		–	0
PCDSCDR		–	0
PCFD		–	0
PCFS		–	0
PCGBL		–	0
PCGDL		–	0
PCGIDL		–	0
PCGISL		–	0
PCGSL		–	0
PCIGBACC		–	0
PCIGBINV		–	0
PCIGC		–	0
PCIGD		–	0
PCIGS		–	0
PCIT		–	0
PCITR		–	0
PCKAPPAB		–	0
PCKAPPAD		–	0

Table 2-136. BSIM-CMG FINFET v108.0.0 Device Model Parameters

Parameter	Description	Units	Default
PCKAPPAS		–	0
PCLM		–	0.013
PCLMCV	CLM parameter for Short Channel CV	–	0
PCLMG		–	0
PCLMR	Reverse Model PCLM parameter	–	0
PCOVD		–	0
PCOVS		–	0
PDEJ	Drain to substrate PN junction perimeter (BULKMOD=1)	–	0
PDELTAVSAT		–	0
PDELTAVSATCV		–	0
PDEO	Perimeter of drain to substrate overlap region through oxide	–	0
PDIBL1	DIBL Output Conductance parameter - forward mode	–	1.3
PDIBL1R	DIBL Output Conductance parameter - reverse mode	–	0
PDIBL2	DIBL Output Conductance parameter	–	0.0002
PDIBL2R	DIBL Output Conductance parameter - reverse mode	–	0
PDROUT		–	0
PDSUB		–	0
PDVT0		–	0
PDVT1		–	0
PDVT1SS		–	0
PDVTB		–	0
PDVTSHIFT		–	0
PDVTSHIFTR		–	0
PEGIDL		–	0
PEGISL		–	0
PEIGBINV		–	0
PEMOBT		–	0
PESATII		–	0
PETA0		–	0
PETA0R		–	0
PETAMOB		–	0
PEU		–	0
PEUR		–	0
PGIDL	parameter for body-bias effect on GIDL	–	0

Table 2-136. BSIM-CMG FINFET v108.0.0 Device Model Parameters

Parameter	Description	Units	Default
PGISL	parameter for body-bias effect on GISL	–	1
PHIBE	Body effect voltage parameter, V, after binnig should be from [0.2:1.2]	–	0.7
PHIG	Gate workfunction, eV	–	4.61
PHIGL	Length dependence of Gate workfunction, eV/m	–	0
PHIGN1	NFIN dependence of Gate workfunction	–	0
PHIGN2	NFIN dependence of Gate workfunction	–	100000
PHIN	Nonuniform vertical doping effect on surface potential, V	–	0.05
PIGCD	parameter for Igc partition	–	1
PIGT		–	0
PIIT		–	0
PK0		–	0
PK01		–	0
PK0SI		–	0
PK0SI1		–	0
PK1		–	0
PK11		–	0
PK1RSCE		–	0
PK1SAT		–	0
PK1SAT1		–	0
PK1SI		–	0
PK1SI1		–	0
PKSATIV		–	0
PKSATIVR		–	0
PKT1		–	0
PLII		–	0
PLPE0		–	0
PLPEB		–	0
PMEXP		–	0
PMEXPR		–	0
PNBODY		–	0
PNGATE		–	0
PNIGBACC		–	0
PNIGBINV		–	0
PNTGEN		–	0

Table 2-136. BSIM-CMG FINFET v108.0.0 Device Model Parameters

Parameter	Description	Units	Default
PNTOX		–	0
POXEDGE	Factor for the gate edge T_{ox}	–	1
PPCLM		–	0
PPCLMCV		–	0
PPCLMG		–	0
PPCLMR		–	0
PPDIBL1		–	0
PPDIBL1R		–	0
PPDIBL2		–	0
PPDIBL2R		–	0
PPGIDL		–	0
PPGISL		–	0
PPHIBE		–	0
PPHIG		–	0
PPHIN		–	0
PPIGCD		–	0
PPOXEDGE		–	0
PPRT		–	0
PPRWGD		–	0
PPRWGS		–	0
PPSAT		–	0
PPSATCV		–	0
PPTWG		–	0
PPTWGR		–	0
PPTWGT		–	0
PPVAG		–	0
PQM	Slope of normalized T_{cen} in inversion	–	0.66
PQMACC	Slope of normalized T_{cen} in accumulation	–	0.66
PQMFACTOR		–	0
PQMCENCV		–	0
PQMCENCVA		–	0
PQMCENIV		–	0
PRDDR	Drain side quasi-saturation parameter	–	0
PRDSW		–	0
PRDW		–	0
PRSDEND		–	0

Table 2-136. BSIM-CMG FINFET v108.0.0 Device Model Parameters

Parameter	Description	Units	Default
PRSDR	Source side quasi-saturation parameter	–	1
PRSW		–	0
PRT		–	0.001
PRWGD	Gate bias dependence of drain extension resistance, Units:1/V	–	0
PRWGS	Gate bias dependence of source extension resistance, Units:1/V	–	0
PSAT	Velocity saturation exponent, after binnig should be from [2.0:inf)	–	2
PSATCV	Velocity saturation exponent for C-V	–	0
PSEJ	Source to substrate PN junction perimeter (BULKMOD=1)	–	0
PSEO	Perimeter of source to substrate overlap region through oxide	–	0
PSII0		–	0
PSII1		–	0
PSII2		–	0
PSIID		–	0
PSTTHETASAT		–	0
PTGIDL		–	0
PTII		–	0
PTSS		–	0
PTWG	Gmsat degradation parameter - forward mode	–	0
PTWGR	Gmsat degradation parameter - reverse mode	–	0
PTWGT		–	0.004
PU0		–	0
PU0R		–	0
PUA		–	0
PUA1		–	0
PUA1R		–	0
PUAR		–	0
PUC		–	0
PUC1		–	0
PUC1R		–	0
PUCR		–	0
PUCS		–	0
PUCSTE		–	0

Table 2-136. BSIM-CMG FINFET v108.0.0 Device Model Parameters

Parameter	Description	Units	Default
PUD		–	0
PUD1		–	0
PUD1R		–	0
PUDR		–	0
PUP		–	0
PUTE		–	0
PUTER		–	0
PUTL		–	0
PUTLR		–	0
PVAG		–	1
PVSAT		–	0
PVSAT1		–	0
PVSAT1R		–	0
PVSATCV		–	0
PVSATR		–	0
PWR		–	0
PXRCRG1		–	0
PXRCRG2		–	0
QM0	Knee-Point for Tcen in inversion (Charge normalized to Cox)	–	0.001
QM0ACC	Knee-Point for Tcen in accumulation (Charge normalized to Cox)	–	0.001
QMFACTOR	Prefactor + switch for QM Vth correction	–	0
QMTCENCV	Prefactor + switch for QM Width and Toxeff correction for CV	–	0
QMTCENCVA	Prefactor + switch for QM Width and Toxeff correction for CV (accumulation region)	–	0
QMTCENIV	Prefactor + switch for QM Width correction for IV	–	0
RDDR	Drain side drift resistance parameter - forward mode	–	0
RDDRR	Drain side drift resistance parameter - reverse mode	–	0
RDSMOD	Resistance model selector	–	0
RDSW		–	100
RDSWMIN		–	0
RDW		–	50
RDWMIN		–	0
RGATEMOD	Gate electrode resistance on/off sector	–	0
RGEOA	Fitting parameter for RGEOMOD=1	–	1

Table 2-136. BSIM-CMG FINFET v108.0.0 Device Model Parameters

Parameter	Description	Units	Default
RGEOB	Fitting parameter for RGEOMOD=1	–	0
RGEOC	Fitting parameter for RGEOMOD=1	–	0
RGEOD	Fitting parameter for RGEOMOD=1	–	0
RGEOE	Fitting parameter for RGEOMOD=1	–	0
RGEOMOD	Geometry-dependent source/drain resistance	–	0
RGEXT	Effective gate electrode external resistance	–	0
RGFIN	Effective gate electrode per finger per fin resistance	–	0.001
RHOC		–	1e-12
RHORS		–	1
RNOIA	Thermal noise coefficient	–	0.577
RNOIB	Thermal noise coefficient	–	0.37
RNOIC	Thermal noise coefficient for TNOIMOD=2	–	0.395
RSDR	Source side drift resistance parameter - forward mode	–	0
RSDRR	Source side drift resistance parameter - reverse mode	–	0
RSHD	Drain-side sheet resistance	–	0
RSHS	Source-side sheet resistance	–	0
RSW		–	50
RSWMIN		–	0
RTH0	Thermal resistance	–	0.01
SCALEN		–	100000
SDTERM		–	0
SHMOD	Self heating and T node switcher — NOT USED IN XYCE	–	0
SII0	Vgs dependent parameter of Iii, 1/V	–	0.5
SII1	1st Vgs dependent parameter of Iii, 1/V	–	0.1
SII2	2nd Vgs dependent parameter of Iii	–	0
SIID	3rd Vds dependent parameter of Iii, 1/V	–	0
SJD	Constant for drain-side two-step second junction	–	0
SJS	Constant for source-side two-step second junction	–	0
SJSWD	Constant for drain-side sidewall two-step second junction	–	0
SJSWGD	Constant for source-side gate sidewall two-step second junction	–	0
SJSWGS	Constant for source-side gate sidewall two-step second junction	–	0
SJSWS	Constant for source-side sidewall two-step second junction	–	0

Table 2-136. BSIM-CMG FINFET v108.0.0 Device Model Parameters

Parameter	Description	Units	Default
TBGASUB	Bandgap Temperature Coefficient (eV / degrees)	–	0.000702
TBGBSUB	Bandgap Temperature Coefficient (degrees)	–	1108
TCJ	Temperature coefficient for CJS/CJD	–	0
TCJSW	Temperature coefficient for CJSWS/CJSWD	–	0
TCJSWG	Temperature coefficient for CJSWGS/CJSWGD	–	0
TEMPMOD		–	0
TETA0	Temperature dependence of DIBL coefficient, 1/K	–	0
TETA0R	Temperature dependence of Reverse-mode DIBL coefficient, 1/K	–	0
TFIN	Body (Fin) thickness	–	1.5e-08
TGATE	Gate height on top of the hard mask	–	3e-08
TGIDL	GIDL/GISL Temperature Dependence	–	-0.003
THETADIBL	DIBL length dependence. If defined by user, will overwrite Theta_DIBL in the code	–	0
THETASCE	Vth roll-off length dependence. If defined by user, will overwrite Theta_SCE in the code	–	0
THETASW	Subthreshold Swing length dependence. If defined by user, will overwrite Theta_SW in the code	–	0
TII	Impact Ionization Temperature Dependence, IIMOD=2	–	0
TMASK	Height of hard mask on top of the fin	–	3e-08
TMEXP		–	0
TMEXPR		–	0
TNJTS	Temperature coefficient for NJTS	–	0
TNJTSD	Temperature coefficient for NJTSD	–	0
TNJTSSW	Temperature coefficient for NJTSSW	–	0
TNJTSSWD	Temperature coefficient for NJTSSWD	–	0
TNJTSSWG	Temperature coefficient for NJTSSWG	–	0
TNJTSSWGD	Temperature coefficient for NJTSSWGD	–	0
TNOIA	Thermal noise parameter	–	1.5
TNOIB	Thermal noise parameter	–	3.5
TNOIC	Thermal noise parameter for TNOIMOD=2	–	3.5
TNOIMOD	0: charge based, 1: holistic thermal noise based on BSIM4 noise model	–	0
TNOM	Temperature at which the model is extracted (degrees)	–	27
TOXG	oxide thickness for gate current model in meters, Introduced in BSIM-CMG106.1.0	–	0
TOXP	physical oxide thickness in meters	–	1.2e-09

Table 2-136. BSIM-CMG FINFET v108.0.0 Device Model Parameters

Parameter	Description	Units	Default
TOXREF	Target tox value [m]	–	1.2e-09
TPB	Temperature coefficient for PBS/PBD	–	0
TPBSW	Temperature coefficient for PBSWS/PBSWD	–	0
TPBSWG	Temperature coefficient for PBSWGS/PBSWGD	–	0
TRDDR		–	0
TRSDDR		–	0
TSILI	Thickness of the silicide on top of the raised source/drain	–	1e-08
TSS	SSwing Temperature Coefficient (/ degrees)	–	0
TYPE		–	0
U0		–	0.03
U0MULT	Variability in carrier mobility	–	1
U0N1	NFIN dependence of U0	–	0
U0N1R		–	0
U0N2	NFIN dependence of U0	–	100000
U0N2R		–	0
U0R		–	0
UA		–	0.3
UA1		–	0.001032
UA1R		–	0
UAR		–	0
UC	Body effect for mobility degradation parameter - BULKMOD=1	–	0
UC1		–	5.6e-11
UC1R		–	0
UCR		–	0
UCS		–	1
UCSTE		–	-0.004775
UD		–	0
UD1		–	0
UD1R		–	0
UDR		–	0
UP		–	0
UPR		–	0
UTE		–	0
UTER		–	0

Table 2-136. BSIM-CMG FINFET v108.0.0 Device Model Parameters

Parameter	Description	Units	Default
UTL		–	-0.0015
UTLR		–	0
VSAT		–	85000
VSAT1	Velocity Saturation parameter for I _{on} degradation - forward mode	–	0
VSAT1N1	NFIN dependence of VSAT1	–	0
VSAT1N2	NFIN dependence of VSAT1	–	0
VSAT1R	Velocity Saturation parameter for I _{on} degradation - reverse mode	–	0
VSAT1RN1	NFIN dependence of VSAT1R	–	0
VSAT1RN2	NFIN dependence of VSAT1R	–	0
VSATCV	Velocity Saturation parameter for CV	–	0
VSATN1	NFIN dependence of VSAT	–	0
VSATN2	NFIN dependence of VSAT	–	100000
VSATR		–	0
VSATRN1	NFIN dependence of VSATR	–	0
VSATRN2	NFIN dependence of VSATR	–	0
VTSD	Bottom drain junction trap-assisted current voltage dependent parameter	–	0
VTSS	Bottom source junction trap-assisted current voltage dependent parameter	–	10
VTSSWD	Unit length trap-assisted current voltage dependent parameter for sidewall drain junction	–	0
VTSSWGD	Unit length trap-assisted current voltage dependent parameter for gate-edge sidewall drain junction	–	0
VTSSWGS	Unit length trap-assisted current voltage dependent parameter for gate-edge sidewall source junction	–	10
VTSSWS	Unit length trap-assisted current voltage dependent parameter for sidewall source junction	–	10
WR		–	1
WTH0	Width dependence coefficient for R _{th} and C _{th}	–	0
XJBVD	Fitting parameter for drain diode breakdown current	–	0
XJBVS	Fitting parameter for source diode breakdown current	–	1
XL	L offset for channel length due to mask/etch effect	–	0
XRRCG1		–	12
XRRCG2		–	1
XTID	Drain junction current temperature exponent	–	0
XTIS	Source junction current temperature exponent	–	3

Table 2-136. BSIM-CMG FINFET v108.0.0 Device Model Parameters

Parameter	Description	Units	Default
XTSD	Power dependence of JTSD on temperature	–	0
XTSS	Power dependence of JTSS on temperature	–	0.02
XTSSWD	Power dependence of JTSSWD on temperature	–	0
XTSSWGD	Power dependence of JTSSWGD on temperature	–	0
XTSSWGS	Power dependence of JTSSWGS on temperature	–	0.02
XTSSWS	Power dependence of JTSSWS on temperature	–	0.02

Table 2-137. MOSFET level 108 Output Variables

Parameter	Description	Units	Default
WEFF	WEFF	–	none
LEFF	LEFF	–	none
WEFFCV	WEFFCV	–	none
LEFFCV	LEFFCV	–	none
IDS	IDS	–	none
IDEFF	IDEFF	–	none
ISEFF	ISEFF	–	none
IGTOT	IGTOT	–	none
IDSGEN	IDSGEN	–	none
III	III	–	none
IGIDL	IGIDL	–	none
IGISL	IGISL	–	none
IJSB	IJSB	–	none
IJDB	IJDB	–	none
ISUB	ISUB	–	none
BETA	BETA	–	none
VTH	VTH	–	none
VDSSAT	VDSSAT	–	none
VFB	VFB	–	none
GM	GM	–	none
GDS	GDS	–	none
GMBS	GMBS	–	none
QGI	QGI	–	none
QDI	QDI	–	none
QSI	QSI	–	none
QBI	QBI	–	none

Table 2-137. MOSFET level 108 Output Variables

Parameter	Description	Units	Default
QG	QG	–	none
QD	QD	–	none
QS	QS	–	none
QB	QB	–	none
CGGI	CGGI	–	none
CGSI	CGSI	–	none
CGDI	CGDI	–	none
CGEI	CGEI	–	none
CDGI	CDGI	–	none
CDDI	CDDI	–	none
CDSI	CDSI	–	none
CDEI	CDEI	–	none
CSGI	CSGI	–	none
CSDI	CSDI	–	none
CSSI	CSSI	–	none
CSEI	CSEI	–	none
CEGI	CEGI	–	none
CEDI	CEDI	–	none
CESI	CESI	–	none
CEEI	CEEI	–	none
CGG	CGG	–	none
CGS	CGS	–	none
CGD	CGD	–	none
CGE	CGE	–	none
CDG	CDG	–	none
CDD	CDD	–	none
CDS	CDS	–	none
CDE	CDE	–	none
CSG	CSG	–	none
CSD	CSD	–	none
CSS	CSS	–	none
CSE	CSE	–	none
CEG	CEG	–	none
CED	CED	–	none
CES	CES	–	none
CEE	CEE	–	none

Table 2-137. MOSFET level 108 Output Variables

Parameter	Description	Units	Default
CGSEXT	CGSEXT	–	none
CGDEXT	CGDEXT	–	none
CGBOV	CGBOV	–	none
CJST	CJST	–	none
CJDT	CJDT	–	none
RSGEO	RSGEO	–	none
RDGEO	RDGEO	–	none
CFGEO	CFGEO	–	none
TDEVICE	TDEVICE	–	none

2.3.20.16. Levels 2000 and 2001 MOSFET Tables (MVS version 2.0.0)

Xyce includes the MIT Virtual Source (MVS) MOSFET model version 2.0.0 in both ETSOI and HEMT variants. The code in Xyce was generated from the MIT Verilog-A input. Model parameters for the MVS model are given in 2-138 and 2-139. The MVS model does not have instance parameters. Details of the model are documented MVS Nanotransistor Model 2.0.0 manual, available from the NEEDS web site at <https://nanohub.org/publications/74/1>.

NOTE: Unlike all other MOSFET models in Xyce, the MVS model takes only 3 nodes, the drain, gate and source. It takes no substrate node.

Table 2-138. MVS ETSOI 2.0.0 Device Model Parameters

Parameter	Description	Units	Default
B		–	6.8e-09
BETA		–	1.55
CINS		–	0.0317
DELTA		–	0.12
DLG		–	1.05e-08
DQM0		–	4.6e-09
ENERGY_DIFF_VOLT		–	0.153
EPS		–	13.6
KSEE		–	0.1
LGDR		–	8e-08
ML		–	0.89
MT		–	0.19
MU_EFF		–	1
N0		–	1.35
ND		–	0
NU		–	0.7
RS0		–	0.00016
THETA		–	2.5
TJUN		–	300
TYPE		–	1
VERSION		–	2
W		–	1e-06

Table 2-139. MVS HEMT 2.0.0 Device Model Parameters

Parameter	Description	Units	Default
B		–	6.8e-09

Table 2-139. MVS HEMT 2.0.0 Device Model Parameters

Parameter	Description	Units	Default
BETA		–	1.55
CINS		–	0.0317
DELTA		–	0.12
DLG		–	1.05e-08
DQM0		–	4.6e-09
ENERGY_DIFF_VOLT		–	0.153
EPS		–	13.6
KSEE		–	0.1
LGDR		–	8e-08
MEFF		–	0.041
MU_EFF		–	1
N0		–	1.35
NACC		–	2.25e+16
ND		–	0
NP_MASS		–	9
RC0		–	0.00016
THETA		–	2.5
TJUN		–	300
TYPE		–	1
VERSION		–	2
W		–	1e-06

2.3.20.17. Level 2002 MOSFET Tables (MVSG_CMC version 1.1.0)

Xyce includes the MIT Virtual Source GaN HEMT High-Voltage (MVSG_CMC) MOSFET model version 1.1.0. The code in Xyce was generated from the MIT Verilog-A input. Model parameters for the MVS model are given in 2-140 and 2-141, and its output variables in 2-142. More information about this model may be obtained from the CMC standard models page at <https://si2.org/standard-models>.

Table 2-140. MVSG-HV HEMT MODEL Device Instance Parameters

Parameter	Description	Units	Default
DTEMP	Device temperature offset from ambient	K	0
L	Effective gate length	m	2.5e-07
NGF	Number of Fingers	—	2
W	Width per Finger	m	0.00018

Table 2-141. MVSG-HV HEMT MODEL Device Model Parameters

Parameter	Description	Units	Default
AF	Flicker noise exponent	—	2
ALPHA	Weak to strong inversion transition factor	—	3.5
ALPHAFP1	FP weak to strong inversion transition factor	—	0.01
ALPHAFP2	FP weak to strong inversion transition factor	—	0.01
ALPHAFP3	FP weak to strong inversion transition factor	—	0.01
ALPHAFP4	FP weak to strong inversion transition factor	—	0.01
ALPHAGD	G-D high injection smoothing parameter	—	10
ALPHAGS	G-S high injection smoothing parameter	—	10
ALPHARD	DAR weak to strong inversion transition factor	—	3.5
ALPHARS	SAR weak to strong inversion transition factor	—	3.5
ALPHAT1	Trap coefficient 1 on bias stress	—	0.0001
ALPHAT2	Trap coefficient 2 on bias stress	V	21
BETA	Linear to saturation parameter	—	1.5
BETAFP1	FP linear to saturation parameter	—	1
BETAFP2	FP linear to saturation parameter	—	1
BETAFP3	FP linear to saturation parameter	—	1
BETAFP4	FP linear to saturation parameter	—	1
BETARD	DAR linear to saturation parameter	—	1
BETARECD	G-D linear to saturation parameter	—	0.25
BETARECS	G-S linear to saturation parameter	—	2
BETARS	SAR linear to saturation parameter	—	1
CBFP1	Body to drain (under FP) cap/width	—	0

Table 2-141. MVSG-HV HEMT MODEL Device Model Parameters

Parameter	Description	Units	Default
CBFP2	Body to drain (under FP) cap/width	—	0
CBFP3	Body to drain (under FP) cap/width	—	0
CBFP4	Body to drain (under FP) cap/width	—	0
CCFP1	Source or gate to drain (under FP) cap/width	—	9e-11
CCFP2	Source or gate to drain (under FP) cap/width	—	3e-11
CCFP3	Source or gate to drain (under FP) cap/width	—	9e-11
CCFP4	Source or gate to drain (under FP) cap/width	—	9e-11
CFP1S	FP (source-side) to source cap/width	—	1e-19
CFP2S	FP (source-side) to source cap/width	—	1e-19
CFP3S	FP (source-side) to source cap/width	—	1e-19
CFP4S	FP (source-side) to source cap/width	—	1e-19
CG	Gate cap/area	—	0.004
CGFP1	FP gate-cap/area	—	0.0002
CGFP2	FP gate-cap/area	—	0.0001
CGFP3	FP gate-cap/area	—	0.0002
CGFP4	FP gate-cap/area	—	0.0002
CGRD	DAR gate-cap/area	—	0.0043
CGRS	SAR gate-cap/area	—	0.005
COFDM	Gate - Drain outer fringing cap/width	—	1e-10
COFDSM	Source - Drain outer fringing cap/width	—	1e-10
COFDSUBM	Sub - Drain outer fringing cap/width	—	0
COFGSUBM	Sub - Gate outer fringing cap/width	—	0
COFSM	Gate - Source outer fringing cap/width	—	1e-09
COFSSUBM	Sub - Source outer fringing cap/width	—	0
CTH	Thermal capacitance	—	0.0001
CTRAP	DC-block capacitor	F	0.001
DELTA1	DIBL Coefficient 1	—	0.016
DELTA1FP1	FP DIBL Coefficient	—	0
DELTA1FP2	FP DIBL Coefficient	—	0
DELTA1FP3	FP DIBL Coefficient	—	0
DELTA1FP4	FP DIBL Coefficient	—	0
DELTA1RD	DAR DIBL Coefficient	—	0.35
DELTA1RS	SAR DIBL Coefficient	—	0.1
DELTA2	DIBL Coefficient 2	—	0
DIBSAT	DIBL saturation Voltage	V	10
EPSILON	Mobility dependence on temperature	—	2.3

Table 2-141. MVSG-HV HEMT MODEL Device Model Parameters

Parameter	Description	Units	Default
FFE	Flicker noise exponent for frequency	—	1.2
FLAGFP1	Flag parameter: GFP=1 or SFP=0	—	1
FLAGFP1S	Flag parameter: cfp1s select=1 or cfp1s not select=0	—	1
FLAGFP2	Flag parameter: GFP=1 or SFP=0	—	0
FLAGFP2S	Flag parameter: cfp1s select=1 or cfp1s not select=0	—	1
FLAGFP3	Flag parameter: GFP=1 or SFP=0	—	0
FLAGFP3S	Flag parameter: cfp1s select=1 or cfp1s not select=0	—	1
FLAGFP4	Flag parameter: GFP=1 or SFP=0	—	0
FLAGFP4S	Flag parameter: cfp1s select=1 or cfp1s not select=0	—	1
FLAGRES	Flag parameter for resistor: resistor is chosen if flagres=1 or implicit transistor is chosen if flagres=0	—	0
FRACD	G-D fractional change in ideality factor due to high injection	—	0.5
FRACS	G-S fractional change in ideality factor due to high injection	—	0.5
GMDISP	Flag parameter for gm-dispersion 0=off, 1=on	—	0
IGMOD	Flag parameter for gate leakage 0=off, 1=on	—	1
IJD	G-D reverse leakage current normalized to width	—	1e-12
IJS	G-S reverse leakage current normalized to width	—	1e-12
IRECD	G-D reverse leakage current normalized to width	—	2e-05
IRECS	G-S reverse leakage current normalized to width	—	1e-18
KBDGATED	G-D fitting parameter to turn on the breakdown of G-D diode	—	0
KBDGATES	G-S fitting parameter to turn on the breakdown of G-S diode	—	0
KF	Flicker noise coefficient	—	0.0001
LAMBDA	CLM parameter	—	0
LGD	Drain access region (DAR) length parameter	m	4.85e-06
LGFP1	FP Length	m	0
LGFP2	FP Length	m	0
LGFP3	FP Length	m	0
LGFP4	FP Length	m	0
LGS	Source access region (SAR) length parameter	m	3e-06
LMAX	Maximum length for use of this model	m	100
LMIN	Minimum length for use of this model	m	0
MINC	Minimum capacitance	F	0
MINL	Minimum length of access or FP regions for modeling them as transistors	m	1e-09

Table 2-141. MVSG-HV HEMT MODEL Device Model Parameters

Parameter	Description	Units	Default
MINR	Minimum resistance	Ω	0.001
MTHETA	Scattering: mobility reduction parameter with Vg	—	0
MTHETAFP1	FP scattering: mobility reduction parameter with Vg	—	0
MTHETAFP2	FP scattering: mobility reduction parameter with Vg	—	0
MTHETAFP3	FP scattering: mobility reduction parameter with Vg	—	0
MTHETAFP4	FP scattering: mobility reduction parameter with Vg	—	0
MTHETARD	DAR scattering: mobility reduction parameter with Vg	—	0
MTHETARS	SAR scattering: mobility reduction parameter with Vg	—	0
MU0	Low-field mobility	—	0.135
MU0FP1	FP low-field mobility	—	0.2
MU0FP2	FP low-field mobility	—	0.2
MU0FP3	FP low-field mobility	—	0.2
MU0FP4	FP low-field mobility	—	0.2
MU0RD	DAR low-field mobility	—	0.1
MU0RS	SAR low-field mobility	—	0.1
ND	Punchthrough factor for subth slope	—	0
NDFP1	FP punchthrough factor for subth slope	—	0
NDFP2	FP punchthrough factor for subth slope	—	0
NDFP3	FP punchthrough factor for subth slope	—	0
NDFP4	FP punchthrough factor for subth slope	—	0
NDRD	DAR punchthrough factor for subth slope	—	3.8
NDRS	SAR punchthrough factor for subth slope	—	0
NOISEMOD	Select knob for noise model 0=off, 1=on	—	0
PBDGD	G-D fitting parameter for breakdown: Something like $1/\eta \cdot V_t$	—	4
PBDGS	G-S fitting parameter for breakdown: Something like $1/\eta \cdot V_t$	—	4
PG_PARAM1	Something like $1/\eta$	—	0.82
PG_PARAMD	G-D something like $1/\eta \cdot V_t$	—	1
PG_PARAMS	G-S something like $1/\eta \cdot V_t$	—	1
PGSRECD	G-D something like $1/\eta$ for reverse recombination	—	0.8
PGSRECS	G-S something like $1/\eta$ for reverse recombination	—	0.5
RCD	Drain contact resistance * Width	—	0.0008
RCS	Source contact resistance * Width	—	0.0008
RCT1	Linear Rsh and Rc temperature coefficient	1/K	0
RCT2	Quadratic Rsh and Rc temperature coefficient	—	0

Table 2-141. MVSG-HV HEMT MODEL Device Model Parameters

Parameter	Description	Units	Default
RGSP	Gate resistance * Width	—	0
RSH	2-DEG Sheet Resistance	—	150
RTH	Thermal resistance	—	25
SFP1	FP Sub-threshold slope	—	3.2
SFP2	FP Sub-threshold slope	—	3.2
SFP3	FP Sub-threshold slope	—	3.2
SFP4	FP Sub-threshold slope	—	3.2
SHD	G-D shot noise parameter	—	3
SHS	G-S shot noise parameter	—	3
SRD	DAR Sub-threshold slope	—	0.3
SRS	SAR Sub-threshold slope	—	0.1
SS	Sub-threshold slope	—	0.12
TAUGMRF	gm-dispersion time constant	s	0.001
TAUT	Trap time constant	s	3e-05
TEMPT	Temperature coefficient for trapping	1/K	0.0001
TNOM	Reference temperature for the model	—	27
TRAPSELECT	Select knob for charge trapping 0=off, 1=on	—	0
TYPE	nFET=1 pFET=-1	—	1
VBDGD	G-D soft breakdown voltage of G-D diode	V	600
VBDGS	G-S soft breakdown voltage of G-S diode	V	600
VERSION	Version number	—	1
VGSATD	G-D high injection effect	V	1
VGSATQD	G-D mimics depletion saturation	V	0.8
VGSATQS	G-S mimics depletion saturation	V	2
VGSATS	G-S high injection effect	V	1
VJG	Gate diode cut in voltage	V	1.1
VTHETA	Scattering: velocity reduction parameter with Vg	—	0
VTHETAFP1	FP scattering: velocity reduction parameter with Vg	—	0
VTHETAFP2	FP scattering: velocity reduction parameter with Vg	—	0
VTHETAFP3	FP scattering: velocity reduction parameter with Vg	—	0
VTHETAFP4	FP scattering: velocity reduction parameter with Vg	—	0
VTHETARD	DAR scattering: velocity reduction parameter with Vg	—	0
VTHETARS	SAR scattering: velocity reduction parameter with Vg	—	0
VTO	Threshold voltage	V	-2.72
VTOFP1	FP threshold voltage	V	-44.5
VTOFP2	FP threshold voltage	V	-74.5

Table 2-141. MVSG-HV HEMT MODEL Device Model Parameters

Parameter	Description	Units	Default
VT0FP3	FP threshold voltage	V	-44.5
VT0FP4	FP threshold voltage	V	-44.5
VTORD	DAR threshold voltage	V	-650
VTORS	SAR threshold voltage	V	-650
VTTRAP	Trapping stress threshold voltage	V	230
VTZETA	vto dependence on temperature	V/K	-0.0004
VX0	Source injection velocity	—	300000
VX0FP1	FP source injection velocity	—	120000
VX0FP2	FP source injection velocity	—	120000
VX0FP3	FP source injection velocity	—	120000
VX0FP4	FP source injection velocity	—	120000
VX0RD	DAR source injection velocity	—	100000
VX0RS	SAR source injection velocity	—	100000
VZETA	vx0 dependence on temperature	1/K	150000
WMAX	Maximum width for use of this model	m	100
WMIN	Minimum width for use of this model	m	0

Table 2-142. MOSFET level 2002 Output Variables

Parameter	Description	Units	Default
vgisi	internal gate-source voltage	V	none
vdisi	internal drain-source voltage	V	none
vti	internal threshold voltage including DIBL	V	none
vdsati	internal drain-source saturation voltage	V	none
pdc	total power dissipation from the device	W	none
idisi	drain-to-source current in intrinsic transistor	A	none
igs	gate-source gate-leakage current	A	none
igd	gate-drain gate-leakage current	A	none
qgi	intrinsic gate charge	C	none
qdi	intrinsic drain charge	C	none
qsi	intrinsic source charge	C	none
qbi	intrinsic body charge	C	none
gmi	intrinsic transconductance	A/V	none
gdsi	intrinsic output-conductance	A/V	none
gmbsi	intrinsic body-transconductance	A/V	none
cggi	intrinsic gate-gate capacitance	F	none

Table 2-142. MOSFET level 2002 Output Variables

Parameter	Description	Units	Default
cgdi	intrinsic gate-drain capacitance	F	none
cgsi	intrinsic gate-source capacitance	F	none
cgbi	intrinsic gate-body capacitance	F	none
cdgi	intrinsic drain-gate capacitance	F	none
cddi	intrinsic drain-drain capacitance	F	none
cdsi	intrinsic drain-source capacitance	F	none
cdbi	intrinsic drain-body capacitance	F	none
csgi	intrinsic source-gate capacitance	F	none
csdi	intrinsic source-drain capacitance	F	none
cssi	intrinsic source-source capacitance	F	none
csbi	intrinsic source-body capacitance	F	none
cbgi	intrinsic body-gate capacitance	F	none
cbdi	intrinsic body-drain capacitance	F	none
cbsi	intrinsic body-source capacitance	F	none
cbbi	intrinsic body-body capacitance	F	none
cgs	gate-to-source fringing capacitance	F	none
cgd	gate-to-drain fringing capacitance	F	none
t_total_k	actual device temperature in Kelvin	K	none
t_total_c	actual device temperature in Celsius	deg C	none
t_delta_sh	change in device temperature caused by self-heating	K	none
rs	resistance of source access region	Ohm	none
rd	resistance of drain access region	Ohm	none

2.3.20.18. Level 260 MOSFET Tables (EKV version 2.6)

Xyce includes the EKV MOSFET model, version 2.6 as the level 260 MOSFET device.

Official documentation of this model may be found at https://www.epfl.ch/labs/iclab/wp-content/uploads/2019/02/ekv_v262.pdf.

We have implemented EKV 2.6 directly from the Verilog-A source published by its authors at <https://github.com/ekv26/model>. While it is a faithful implementation of the model provided there, we have had anecdotal evidence that other simulators have different implementations that contain additional parameters and possibly a different extrinsic model. Model cards containing parameters extracted from other simulators may not result in Xyce simulations that match those other simulators. Watch carefully for any warnings from Xyce regarding unrecognized model parameters, as these are a strong indication that the model card is not extracted using the exact version of EKV provided by Xyce.

Tables of EKV MOSFET 2.6 parameters are in tables 2-143 and 2-144.

Note that in the tables the device claims that the default TNOM and TEMP parameter values is 1e21. This is merely an artifact of an unusual way the authors have defined those parameters in the Verilog-A source. In fact, if not given TNOM defaults to 25 ° C, and if not given TEMP defaults to the ambient temperature of the simulation.

Table 2-143. EKV MOSFET version 2.6 Device Instance Parameters

Parameter	Description	Units	Default
AD		–	0
AS		–	0
L		–	1e-05
M		–	1
NS		–	1
PD		–	0
PS		–	0
W		–	1e-05

Table 2-144. EKV MOSFET version 2.6 Device Model Parameters

Parameter	Description	Units	Default
AD		–	0
AF		–	1
AGAMMA		–	1e-06
AKP		–	1e-06
AS		–	0
AVTO		–	1e-06
BEX		–	-1.5
COX		–	0.002

Table 2-144. EKV MOSFET version 2.6 Device Model Parameters

Parameter	Description	Units	Default
DL		–	-1e-08
DW		–	-1e-08
E0		–	1e+08
GAMMA		–	0.7
HDIF		–	5e-07
IBA		–	5e+08
IBB		–	4e+08
IBBT		–	0.0009
IBN		–	1
KF		–	0
KP		–	0.00015
L		–	1e-05
LAMBDA		–	0.8
LETA		–	0.3
LK		–	4e-07
LMAX		–	100
LMIN		–	0
M		–	1
NOISE		–	1
NS		–	1
PD		–	0
PHI		–	0.5
PS		–	0
Q0		–	0.00023
RSH		–	0
TCV		–	0.001
TEMP		–	1e+21
THETA		–	0
TNOM		–	1e+21
TP_CJ		–	0
TP_CJSW		–	0
TP_CJSWG		–	0
TP_NJTS		–	0
TP_NJTSSW		–	0
TP_NJTSSWG		–	0
TP_PB		–	0

Table 2-144. EKV MOSFET version 2.6 Device Model Parameters

Parameter	Description	Units	Default
TP_PBSW		–	0
TP_PBSWG		–	0
TP_XTI		–	3
TRISE		–	0
TYPE		–	1
UCEX		–	0.8
UCRIT		–	2e+06
VTO		–	0.5
W		–	1e-05
WETA		–	0.2
WMAX		–	100
WMIN		–	0
XD_BV		–	10
XD_CJ		–	1e-09
XD_CJSW		–	1e-12
XD_CJSWG		–	1e-12
XD_GMIN		–	0
XD_JS		–	1e-09
XD_JSW		–	1e-12
XD_JSWG		–	1e-12
XD_MJ		–	0.9
XD_MJSW		–	0.7
XD_MJSWG		–	0.7
XD_N		–	1
XD_NJTS		–	1
XD_NJTSSW		–	1
XD_NJTSSWG		–	1
XD_PB		–	0.8
XD_PBSW		–	0.6
XD_PBSWG		–	0.6
XD_VTS		–	0
XD_VTSSW		–	0
XD_VTSSWG		–	0
XD_XJBV		–	0
XJ		–	3e-07

2.3.20.19. Level 301 MOSFET Tables (EKV version 3.0.1)

Xyce includes the EKV MOSFET model, version 3.0.1 [19][31][32]. Full documentation for the EKV3 model is available on the Xyce internal web site; the documentation for the EKV3 model may be freely redistributed. Instance and model parameters for the EKV model are given in tables 2-145 and 2-146.

The EKV3 model is developed by the EKV Team of the Electronics Laboratory-TUC (Technical University of Crete). It is included in Xyce under license from Technical University of Crete. The official web site of the EKV model is <http://ekv.epfl.ch/>.

Due to licensing restrictions, the EKV3 MOSFET is not available in open-source versions of Xyce. The license for EKV3 authorizes Sandia National Laboratories to distribute EKV3 only in binary versions of code.

Table 2-145. EKV3 MOSFET Device Instance Parameters

Parameter	Description	Units	Default
AD	DRAIN'S AREA	–	0
AS	SOURCE'S AREA	–	0
L	GATE'S LENGTH	–	1e-05
M	NUMBER OF DEVICES IN PARALLEL	–	1
NF	NUMBER OF FINGERS	–	1
PD	DRAIN'S PERIMETER	–	0
PS	SOURCE'S PERIMETER	–	0
SA	STI PARAMETER; DISTANCE FROM STI	–	0
SB	STI PARAMETER; DISTANCE FROM STI	–	0
SD	STI PARAMETER; DISTANCE BETWEEN GATES	–	0
W	GATE'S WIDTH	–	1e-05

Table 2-146. EKV3 MOSFET Device Model Parameters

Parameter	Description	Units	Default
ACLM		–	0.83
AF		–	1
AGAM		–	0
AGAMMA	MATCHING PARAMETER FOR BODY FACTOR (GAMMA)	–	0
AGIDL		–	0
AKP	MATCHING PARAMETER FOR MOBILITY (KP)	–	0
AQMA		–	0.5
AQMI		–	0.4
AVT		–	0

Table 2-146. EKV3 MOSFET Device Model Parameters

Parameter	Description	Units	Default
AVTO	MATCHING PARAMETER FOR THRESHOLD VOLTAGE (VTO)	–	0
BEX		–	-1.5
BGIDL		–	2.3e+09
BVD		–	10
BVS		–	10
CGBO		–	0
CGDO		–	0
CGIDL		–	0.5
CGSO		–	0
CJD		–	0
CJF		–	0
CJS		–	0
CJSWD		–	0
CJSWGD		–	0
CJSWGS		–	0
CJSWS		–	0
COX		–	0.012
DDITS		–	0.3
DELTA		–	2
DFR		–	0.001
DGAMMAEDGE		–	0
DL		–	-1e-08
DLC		–	0
DPHIEDGE		–	0
DW		–	-1e-08
DWC		–	0
E0		–	1e+10
E1		–	3.1e+08
EB		–	2.9e+10
EF		–	2
EGIDL		–	0.8
ETA		–	0.5
ETAD		–	1
ETAQM		–	0.75
FLR		–	0

Table 2-146. EKV3 MOSFET Device Model Parameters

Parameter	Description	Units	Default
FPROUT		–	1e+06
GAMMA		–	0.3
GAMMAG		–	4.1
GAMMAGOV		–	10
GAMMAOV		–	1.6
GC		–	1
GMIN		–	0
HDIF		–	0
IBA		–	0
IBB		–	3e+08
IBBT		–	0.0008
IBN		–	1
INFO_LEVEL		–	0
JSD		–	0
JSS		–	0
JSSWD		–	0
JSSWGD		–	0
JSSWGS		–	0
JSSWS		–	0
JTSD		–	0
JTSS		–	0
JTSSWD		–	0
JTSSWGD		–	0
JTSSWGS		–	0
JTSSWS		–	0
KA		–	0
KB		–	0
KETAD		–	0
KF		–	0
KG		–	0
KGAMMA		–	0
KGFN		–	0
KJF		–	0
KKP		–	0
KP		–	0.0005
KRGL1		–	0

Table 2-146. EKV3 MOSFET Device Model Parameters

Parameter	Description	Units	Default
KUCRIT		–	0
KVTO		–	0
LA		–	1
LAMBDA		–	0.5
LB		–	1
LDIF		–	0
LDPHIEDGE		–	0
LDW		–	0
LETA		–	0.5
LETA0		–	0
LETA2		–	0
LGAM		–	1
LKKP		–	0
LKVTO		–	0
LL		–	0
LLN		–	1
LLODKKP		–	1
LLODKVTO		–	1
LNWR		–	0
LODKETAD		–	1
LODKGAMMA		–	1
LOV		–	2e-08
LOVIG		–	2e-08
LQWR		–	0
LR		–	5e-08
LVT		–	1
LWR		–	0
MJD		–	0.9
MJS		–	0.9
MJSWD		–	0.7
MJSWGD		–	0.7
MJSWGS		–	0.7
MJSWS		–	0.7
N0		–	1
NCS		–	1
NFVTA		–	0

Table 2-146. EKV3 MOSFET Device Model Parameters

Parameter	Description	Units	Default
NVFTB		–	10000
NJD		–	1
NJS		–	1
NJTSD		–	1
NJTSS		–	1
NJTSSWD		–	1
NJTSSWGD		–	1
NJTSSWGS		–	1
NJTSSWS		–	1
NLR		–	0.01
NQS_NOI		–	1
NWR		–	0.005
PBD		–	0.8
PBS		–	0.8
PBSWD		–	0.6
PBSWGD		–	0.6
PBSWGS		–	0.6
PBSWS		–	0.6
PDITS		–	0
PDITSD		–	1
PDITSL		–	0
PHIF	FERMI BULK POTENTIAL	–	0.45
PKKP		–	0
PKVTO		–	0
QLR		–	0.0005
QOFF		–	0
QWR		–	0.0003
RBN		–	0
RBWSH		–	0.003
RD		–	0
RDBN		–	0
RDBWSH		–	0.001
RDSBSH		–	1000
RDX		–	-1
RGSH		–	3
RINGTYPE		–	1

Table 2-146. EKV3 MOSFET Device Model Parameters

Parameter	Description	Units	Default
RLX	EXTERNAL SERIES RESISTANCE	–	-1
RS		–	0
RSBN		–	0
RSBWSH		–	0.001
RSH		–	0
RSX		–	-1
SAREF		–	0
SBREF		–	0
SCALE		–	1
SIGMAD		–	1
SIGN	SIGN = 1 FOR NMOS; SIGN = -1 FOR PMOS	–	1
TCJ		–	0
TCJSW		–	0
TCJSWG		–	0
TCV		–	0.0006
TCVL		–	0
TCVW		–	0
TCVWL		–	0
TE0EX		–	0.5
TE1EX		–	0.5
TETA		–	-0.0009
TG	TYPE OF GATE: -1 ENHANCEMENT TYPE; 1 DEPLETION TYPE	–	-1
TH_NOI		–	0
THC		–	0
TKKP		–	0
TLAMBDA		–	0
TNJTSD		–	0
TNJTSS		–	0
TNJTSSWD		–	0
TNJTSSWGD		–	0
TNJTSSWGS		–	0
TNJTSSWS		–	0
TNOM		–	27
TPB		–	0
TPBSW		–	0

Table 2-146. EKV3 MOSFET Device Model Parameters

Parameter	Description	Units	Default
TPBSWG		–	0
TR		–	0
TR2		–	0
UCEX		–	1.5
UCRIT		–	5e+06
VBI		–	0
VFBOV		–	0
VFR		–	0
VOV		–	1
VTO	THRESHOLD VOLTAGE	–	0.3
VTSD		–	0
VTSS		–	0
VTSSWD		–	0
VTSSWGD		–	0
VTSSWGS		–	0
VTSSWS		–	0
WDL		–	0
WDPHIEDGE		–	0
WE0		–	0
WE1		–	0
WEDGE		–	0
WETA		–	0.2
WETAD		–	0
WGAM		–	1
WKKP		–	0
WKP1		–	1e-06
WKP2		–	0
WKP3		–	1
WKVTO		–	0
WLAMBDA		–	0
WLDGAMMAEDGE		–	0
WLDPHIEDGE		–	0
WLOD		–	0
WLODKKP		–	1
WLODKVTO		–	1
WLR		–	0

Table 2-146. EKV3 MOSFET Device Model Parameters

Parameter	Description	Units	Default
WNLR		–	0
WQLR		–	0
WR		–	9e-08
WRLX		–	0
WUCEX		–	0
WUCRIT		–	0
WVT		–	1
XB		–	3.1
XJ		–	2e-08
XJBVD		–	0
XJBVS		–	0
XL		–	0
XTID		–	3
XTIS		–	3
XTSD		–	0
XTSS		–	0
XTSSWD		–	0
XTSSWGD		–	0
XTSSWGS		–	0
XTSSWS		–	0
XW		–	0
ZC		–	1e-06

2.3.20.20. Level 10240 MOSFET Tables (L_UTSOI Version 102.4.0)

Select Xyce binaries include the L_UTSOI MOSFET model as the level 10240 MOSFET. This model's parameters and output variables are listed in tables 2-147, 2-148, and 2-149

Table 2-147. L_UTSOI MOSFET Device Instance Parameters

Parameter	Description	Units	Default
ADRAIN	Drain region area	m ²	1e-12
ASOURCE	Source region area	m ²	1e-12
DELVTO	Threshold voltage shift parameter	V	0
FACTUO	Low-field mobility pre-factor	—	1
L	Channel length	m	1e-06
M	multiplicity factor	—	1
MULT	Number of devices in parallel	—	1
NF	Number of fingers	—	1
PDRAIN	Drain region perimeter	m	1e-06
PSOURCE	Source region perimeter	m	1e-06
SA	Distance between OD-edge and poly at source side	m	0
SB	Distance between OD-edge and poly at drain side	m	0
SD	Distance between neighboring fingers	m	0
W	Channel width	m	1e-06

Table 2-148. L_UTSOI MOSFET Device Model Parameters

Parameter	Description	Units	Default
A1	Impact ionization pre-factor	—	1
A1L	Length dependence of A1	—	0
A10	Geometry independent impact ionization pre-factor	—	1
A1W	Width dependence of A1	—	0
A2	Impact ionization exponent at TR	—	10
A20	Impact ionization exponent at TR	—	10
A3	Saturation voltage dependence of impact-ionization	—	1
A3L	Length dependence of A3	—	0
A30	Geometry independent saturation-voltage dependence of II	—	1
A3W	Width dependence of A3	—	0
AGIDL	GIDL pre-factor	A/V ³	0
AGIDL D	GIDL pre-factor at drain side	A/V ³	0
AGIDLDO	GIDL geometry independent pre-factor at drain side	A/V ³	0

Table 2-148. L_UTSOI MOSFET Device Model Parameters

Parameter	Description	Units	Default
AGIDLW	GIDL pre-factor for a width of WEN at drain side	A/V^3	0
AGIDLO	GIDL geometry independent pre-factor	A/V^3	0
AGIDLW	GIDL pre-factor for a width of WEN	A/V^3	0
ALP	CLM pre-factor	—	0
ALP1	CLM enhancement factor above threshold	V	0
ALP1L1	Length dependence of CLM enhancement factor above threshold ALP1	V	0
ALP1L2	Second order length dependence of ALP1	—	0
ALP1LEXP	Exponent for length dependence of ALP1	—	0.5
ALP1LEXP2	Exponent for second order length dependence of ALP1	—	1.5
ALP1W	Width dependence of ALP1	—	0
ALPB	Back bias dependence of channel length modulation	—	0
ALPBO	Back bias dependence of channel length modulation	—	0
ALPL1	Length dependence of CLM pre-factor ALP	—	0
ALPL2	Second order length dependence of ALP	—	0
ALPLEXP	Exponent for length dependence of ALP	—	1
ALPLEXP2	Exponent for second order length dependence of ALP	—	2
ALPW	Width dependence of ALP	—	0
AREAQ	Effective channel area for intrinsic CV	m^2	1e-12
AX	Linear/saturation transition exponent	—	8
AXL	Length dependence of AX	—	0
AXL2	Second order length dependence of AX	—	0
AXLEXP	Exponent for length dependence of AX	—	1
AXLEXP2	Exponent for second order length dependence of AX	—	1.5
AXO	Geometry independent linear/saturation transition exponent	—	8
BETN	Front channel aspect ratio times zero-field mobility	$m^2/(Vs)$	0.05
BETNB	Back channel over front channel zero-field mobility ratio	—	1
BETNBO	Back channel over front channel zero-field mobility ratio	—	1
BETW1	First width dependence modulation of BETN	—	0
BETW2	Second width dependence modulation of BETN	—	0
BGIDL	GIDL probability factor at TR	V	41
BGIDLD	GIDL probability factor at TR at drain side	V	41
BGIDLDO	GIDL probability factor at TR at drain side	V	41

Table 2-148. L_UTSOI MOSFET Device Model Parameters

Parameter	Description	Units	Default
BGIDLO	GIDL probability factor at TR	V	41
CF	DIBL parameter	—	0
CFB	DIBL back to front interface asymmetry factor	—	1
CFBO	DIBL back to front interface asymmetry factor	—	1
CFD	Drain voltage dependence parameter of DIBL	V	0.2
CFDL	DIBL modulation coefficient due to L_{eff} variation	—	0
CFDLB	Back bias dependence of DIBL modulation	—	0
CFDLBO	Back bias dependence of DIBL modulation	—	0
CFDLL	DIBL modulation coefficient due to L_{eff} variation	—	0
CFDLW	Width dependence of CFDL	—	0
CFDO	Drain voltage dependence parameter of DIBL	V	0.2
CFL	Length dependence of DIBL-parameter	—	0
CFLEXP	Exponent for length dependence of CF	—	2
CFR	Outer fringe capacitance per side	F	0
CFRD	Outer fringe capacitance at drain side	F	0
CFRDO	Corner related outer fringe capacitance at drain side	F	0
CFRDW	Outer fringe capacitance per side for a width of WEN at drain side	F	0
CFRO	Corner related outer fringe capacitance	F	0
CFRW	Outer fringe capacitance per side for a width of WEN	F	0
CFW	Width dependence of CF	—	0
CGBOV	Oxide capacitance for gate-substrate overlap	F	0
CGBOVL	Length dependent gate-substrate overlap capacitance part for a length of LEN	F	0
CGBOVO	Geometry independent gate-substrate overlap capacitance part	F	0
CGIDL	Substrate bias dependence of GIDL	V^{-1}	0
CGIDLD	Substrate bias dependence of GIDL at drain side	V^{-1}	0
CGIDLDO	Substrate bias dependence of GIDL at drain side	V^{-1}	0
CGIDLO	Substrate bias dependence of GIDL	V^{-1}	0
CHIB	Tunneling barrier height	V	3.1
CHIBO	Tunneling barrier height	V	3.1
CIC	Long channel back interface coupling coefficient	—	1
CICF	Long channel front interface coupling coefficient	—	1
CICFO	Long channel front interface coupling coefficient	—	1
CICO	Long channel back interface coupling coefficient	—	1
COV	Overlap capacitance per side	F	0

Table 2-148. L_UTSOI MOSFET Device Model Parameters

Parameter	Description	Units	Default
COVD	Overlap capacitance at drain side	F	0
COVDL	Overlap capacitance modulation coefficient due to L_{eff} variation	—	0
COVDLB	Overlap capacitance modulation with back bias	—	0
COVDLBO	Overlap capacitance modulation with back bias	—	0
COVDLO	Overlap capacitance modulation coefficient due to L_{eff} variation	—	0
COVDLW	Width dependence of COVDL	—	0
CS	Remote Coulomb scattering parameter at TR	—	0
CSBI	Field dependence of Coulomb scattering at back interface	—	0
CSBIO	Field dependence of Coulomb scattering at back interface	—	0
CSD	Drain-source capacitance	F	1.04e-18
CSDBP	Drain/source to substrate perimeter capacitance	—	0
CSDBPO	Drain/source to substrate perimeter capacitance	—	0
CSDO	Drain-source capacitance correction factor	—	1
CSFI	Field dependence of Coulomb scattering at front interface	—	0
CSFIO	Field dependence of Coulomb scattering at front interface	—	0
CSL	Length dependence of CS	—	0
CSLEXP	Exponent describing length dependence of CS	—	1
CSLW	Area dependence of CS	—	0
CSO	Remote Coulomb scattering parameter at TR	—	0
CSTHR	Remote Coulomb scattering threshold level	—	2
CSTHRB	Remote Coulomb scattering threshold asymmetry parameter	—	1
CSTHRBO	Remote Coulomb scattering threshold asymmetry parameter	—	1
CSTHRO	Remote Coulomb scattering threshold level	—	2
CSW	Width dependence of CS	—	0
CT	Interface states factor	—	0
CTH	Thermal capacitance	—	1e-11
CTHO	Geometry independent thermal capacitance	—	1e-12
CTO	Interface states factor	—	0
DGIDL	High longitudinal field parameter of GIDL	V ⁻¹	0

Table 2-148. L_UTSOI MOSFET Device Model Parameters

Parameter	Description	Units	Default
DGIDLD	High longitudinal field parameter of GIDL at drain side	V ⁻¹	0
DGIDLDL	High longitudinal field parameter of GIDL at drain side	V ⁻¹	0
DGIDLDO	High field geometry independent parameter of GIDL at drain side	V ⁻¹	0
DGIDLL	High longitudinal field parameter of GIDL	V ⁻¹	0
DGIDLO	High field geometry independent parameter of GIDL	V ⁻¹	0
DLQ	Effective channel length additional offset for charge model	m	0
DVFBOV	Overlap capacitance flat-band voltage adjustment	V	0
DVFBOVO	Overlap capacitance flat-band voltage adjustment	V	0
DWQ	Effective channel width additional offset for charge model	m	0
EF	Frequency coefficient of flicker noise	—	1
EFO	Frequency coefficient of flicker noise	—	1
FBET1	First length dependence modulation of BETN	—	0
FBET1W	Width dependence of FBET1	—	0
FBET2	Second length dependence modulation of BETN	—	0
FETA	Effective field parameter	—	1
FETAO	Effective field parameter	—	1
FIF	Inner fringe capacitance prefactor	—	0
FIFW	Inner fringe capacitance prefactor for a width of WEN	—	0
FNOVINV	Extra gate to overlap current pre-factor in inversion	A	0
FNOVINVD	Extra gate to overlap current pre-factor in inversion at drain side	A	0
FNOVINVDW	Extra gate to overlap current pre-factor for a width of WEN in inversion at drain side	A	0
FNOVINVW	Extra gate to overlap current pre-factor for a width of WEN in inversion	A	0
FNT	Thermal noise coefficient	—	1
FNTEXC	Excess noise coefficient	—	0
FNTEXCCL	Length dependence coefficient of excess noise	—	0
FNTEXCLEXP	Length dependence exponent of excess noise	—	2
FNTO	Thermal noise coefficient	—	1
FSCEAC	Short channel effect adjustment factor for charge model	—	0
FSCEACO	Short channel effect adjustment factor for charge model	—	0

Table 2-148. L_UTSOI MOSFET Device Model Parameters

Parameter	Description	Units	Default
FTHO	First neighbour thermal coupling factor for multifinger devices	—	0
GC2CH	Gate to channel current slope factor	—	0.375
GC2CHO	Gate to channel current slope factor	—	0.375
GC2OVACC	Gate current slope factor for overlap regions in accumulation mode	—	0.375
GC2OVACCO	Gate current slope factor for overlap regions in accumulation mode	—	0.375
GC2OVINV	Gate current slope factor for overlap regions in inversion mode	—	0.375
GC2OVINV0	Gate current slope factor for overlap regions in inversion mode	—	0.375
GC3CH	Gate to channel current curvature factor	—	0.063
GC3CHO	Gate to channel current curvature factor	—	0.063
GC3OVACC	Gate current curvature factor for overlap regions in accumulation mode	—	0.063
GC3OVACCO	Gate current curvature factor for overlap regions in accumulation mode	—	0.063
GC3OVINV	Gate current curvature factor for overlap regions in inversion mode	—	0.063
GC3OVINV0	Gate current curvature factor for overlap regions in inversion mode	—	0.063
GCDOV	High drain voltage dependence of overlap gate current	V ⁻¹	0
GCDOVL	High drain voltage dependence of overlap gate current	V ⁻¹	0
GCO	Gate tunneling energy adjustment in inversion	—	0
GCOO	Gate tunneling energy adjustment in inversion	—	0
GCOVINVFN	Extra gate current slope factor for overlap regions in inversion mode	—	0.2
GCOVINVFNO	Extra gate current slope factor for overlap regions in inversion mode	—	0.2
GCVDOV	Threshold of high drain voltage effect on overlap gate current	V	1
GCVDOVO	Threshold of high drain voltage effect on overlap gate current	V	1
IGINV	Gate to channel current pre-factor	A	0
IGINVLW	Gate to channel current pre-factor for a channel area of WEN.LEN	A	0
IGOVACC	Gate to overlap current pre-factor in accumulation	A	0
IGOVACCD	Gate to overlap current pre-factor in accumulation at drain side	A	0

Table 2-148. L_UTSOI MOSFET Device Model Parameters

Parameter	Description	Units	Default
IGOVACCDW	Gate to overlap current pre-factor for a width of WEN in accumulation at drain side	A	0
IGOVACCW	Gate to overlap current pre-factor for a width of WEN in accumulation	A	0
IGOVINV	Gate to overlap current pre-factor in inversion	A	0
IGOVINVD	Gate to overlap current pre-factor in inversion at drain side	A	0
IGOVINVDW	Gate to overlap current pre-factor for a width of WEN in inversion at drain side	A	0
IGOVINW	Gate to overlap current pre-factor for a width of WEN in inversion	A	0
KUO	Mobility degradation/enhancement coefficient	m	0
KVSAT	Saturation velocity degradation/enhancement coefficient	—	0
KVTHO	Threshold shift parameter	Vm	0
LAMBTHO	Characteristic length of lateral thermal coupling for multifinger devices	m	1e-07
LAP	Effective channel length reduction per side	m	0
LKUO	Length dependence of KUO	—	0
LKVTHO	Length dependence of KVTHO	—	0
LLODKUO	Length parameter for UO stress effect	—	0
LLODVTH	Length parameter for VTH-stress effect	—	0
LODETAO	Eta0 shift modification factor for stress effect	—	1
LOVDO	Overlap length for gate/drain hdd overlap capacitance	m	0
LOVO	Overlap length for gate/source-drain hdd overlap capacitance	m	0
LP1	First characteristic length of BETN scaling	m	1e-08
LP1W	Width dependence of LP1	—	0
LP2	Second characteristic length of BETN scaling	m	1e-08
LVARL	Length dependence of LPS	—	0
LVARO	Geometry independent difference between physical and drawn gate lengths	m	0
LVARW	Width dependence of LPS	—	0
MUE	Front channel mobility reduction coefficient at TR	—	0
MUEO	Front channel mobility reduction coefficient at TR	—	0
NCH	Thin film doping (n-type=negative value, p-type=positive value)	—	0
NCHO	Thin film doping (n-type=negative value, p-type=positive value)	—	0

Table 2-148. L_UTSOI MOSFET Device Model Parameters

Parameter	Description	Units	Default
NFA	First coefficient of flicker noise	—	8e+22
NFALW	First coefficient of flicker noise	—	8e+22
NFAW	Long channel first coefficient of flicker noise	—	0
NFB	Second coefficient of flicker noise	—	3e+07
NFBLW	Second coefficient of flicker noise	—	3e+07
NFC	Third coefficient of flicker noise	V ⁻¹	0
NFCLW	Third coefficient of flicker noise	V ⁻¹	0
NFE	Flicker noise front transverse field effect coefficient	—	0
NFEB	Flicker noise back transverse field effect coefficient	—	0
NFEBO	Flicker noise back transverse field effect coefficient	—	0
NFEO	Flicker noise front transverse field effect coefficient	—	0
NIGINV	Gate tunneling slope adjustment in subthreshold regime	—	0
NIGINVO	Gate tunneling slope adjustment in subthreshold regime	—	0
NOV	Effective doping of overlap-ldd regions	—	1e+20
NOVD	Effective doping of overlap-ldd regions ar drain side	—	1e+20
NOVDO	Effective doping of overlap-ldd regions at drain side	—	1e+20
NOVO	Effective doping of overlap-ldd regions	—	1e+20
NSDAC	Source/Drain effective doping level for AC model	—	1e+22
NSDACO	Source/Drain effective doping level for AC model	—	1e+22
NSDDC	Source/Drain effective doping level for DC model	—	1e+22
NSDDCO	Source/Drain effective doping level for DC model	—	1e+22
NSUB	Substrate doping (n-type=negative value, p-type=positive value)	—	3e+18
NSUBO	Substrate doping (n-type=negative value, p-type=positive value)	—	3e+18
PKUO	Cross-term dependence of KUO	—	0
PKVTHO	Cross-term dependence of KVTHO	—	0
PNCE	Narrow channel effect on body factor	—	0
PNCEW	Narrow channel effect on body factor for a width of WEN	—	0
PSCE	Short channel effect coefficient	—	0
PSCEB	Short channel back to front interface asymmetry factor	—	1
PSCEBO	Short channel back to front interface asymmetry factor	—	1
PSCEDLB	Back bias dependence of short channel effect modulation	—	0

Table 2-148. L_UTSOI MOSFET Device Model Parameters

Parameter	Description	Units	Default
PSCEDLBO	Back bias dependence of short channel effect modulation	—	0
PSCEL	Length dependence of PSCE	—	0
PSCELEXP	Exponent describing length dependence of PSCE	—	2
PSCEW	Width dependence of PSCE	—	0
QMC	Quantum correction factor (no correction=0, full correction=1)	—	1
RS	Source/Drain series resistance at TR	Ω	30
RSB	Back bias dependence of RS	—	0
RSBO	Back bias dependence of RS	—	0
RSG	Transverse electric field dependence of RS	—	0
RSGO	Transverse electric field dependence of RS	—	0
RSIG	Source/Drain extension resistance coefficient	—	0
RSIGO	Source/Drain extension resistance coefficient	—	0
RSW1	Source/Drain series resistance for channel width WEN at TR	Ω	30
RSW2	Higher-order width scaling of source/drain series resistance	—	0
RTH	Thermal resistance	—	10000
RTHL	Length dependence of RTH	—	1.5
RTHLW	Area dependence of RTH	—	4.5
RTHO	Geometry independent thermal resistance	—	100000
RTHW	Width dependence of RTH	—	3
SAREF	Reference distance between OD-edge and poly from one side	m	1e-06
SBREF	Reference distance between OD-edge and poly from other side	m	1e-06
STA2	Temperature dependence of A2	—	0
STA2O	Temperature dependence of A2	—	0
STBET	Temperature dependence of BETN	—	1.5
STBETL	Length dependence of STBET	—	0
STBETLW	Area dependence of STBET	—	0
STBETO	Geometry independent temperature dependence of BETN	—	1.5
STBETW	Width dependence of STBET	—	0
STBGIDL	Temperature dependence of BGIDL	V/K	0
STBGIDLD	Temperature dependence of BGIDL at drain side	V/K	0
STBGIDLDO	Temperature dependence of BGIDL at drain side	V/K	0

Table 2-148. L_UTSOI MOSFET Device Model Parameters

Parameter	Description	Units	Default
STBGIDLO	Temperature dependence of BGIDL	V/K	0
STCF	Temperature dependence of CF, with same scaling as CF	1/K	0
STCFL	Temperature dependence of CF, with same scaling as CF	1/K	0
STCS	Temperature dependence of CS	—	0
STCSL	Length dependence of STCS	—	0
STCSLW	Area dependence of STCS	—	0
STCSO	Temperature dependence of CS	—	0
STCSW	Width dependence of STCS	—	0
STETA0	Eta0 shift factor related to VTH0 change	m	0
STIG	Temperature dependence of all gate currents	—	0
STIGFN	Temperature dependence of extra gate to overlap current	—	0
STIGFNO	Temperature dependence of extra gate to overlap current	—	0
STIGO	Temperature dependence of all gate currents	—	0
STMUE	Temperature dependence of MUE	—	0
STMUEO	Temperature dependence of MUE	—	0
STRALPHA	Asymmetry parameter	—	3
STRDCF	DIBL variation parameter	—	0
STRDVFBO	Threshold shift parameter	V	0
STRLAMBDA	Relaxation characteristic length	m	1e-07
STRRUO	Mobility degradation/enhancement coefficient	—	0
STRRVSAT	Saturation velocity degradation/enhancement coefficient	—	0
STRS	Temperature dependence of RS	—	0
STRSO	Temperature dependence of RS	—	0
STRTH	Temperature dependence of RTH	—	0
STRTHO	Temperature dependence of RTH	—	0
STRTRUO	Temperature dependence of mobility degradation/enhancement coefficient	—	0
STRWDFB0	Width dependence of threshold shift parameter	—	0
STTHECS	Temperature dependence of THECS	—	0
STTHECSO	Temperature dependence of THECS	—	0
STTHEMU	Temperature dependence of THEMU	—	0
STTHEMUO	Temperature dependence of THEMU	—	0
STTHESAT	Temperature dependence of THESAT	—	-0.1

Table 2-148. L_UTSOI MOSFET Device Model Parameters

Parameter	Description	Units	Default
STTHESATL	Length dependence of STTHESAT	—	0
STTHESATLW	Area dependence of STTHESAT	—	0
STTHESATO	Geometry independent temperature dependence of THESAT	—	-0.1
STTHESATW	Width dependence of STTHESAT	—	0
STVFB	Temperature dependence of VFB and VFBB	V/K	0
STVFBL	Length dependence of STVFB	—	0
STVFBLW	Area dependence of STVFB	—	0
STVFBO	Geometry-independent temperature dependence of VFB and VFBB	V/K	0
STVFBW	Width dependence of STVFB	—	0
STXCOR	Temperature dependence of XCOR	—	0
STXCORO	Temperature dependence of XCOR	—	0
SWGIDL	Flag for GIDL current (without=0, with=1)	—	0
SWGATE	Flag for gate current (without=0, with=1)	—	0
SWIGN	Flag for induced gate noise model (without=0, with=1)	—	1
SWIMPACT	Flag for impact ionization current (without=0, with=1)	—	0
SWJUNASYM	Flag for source/drain junction asymmetry (without=0, with=1)	—	0
SWSCALE	Parameter set mode (local=0, global=1)	—	0
SWSHE	Flag for self heating effect (without=0, with=1)	—	0
SWSTRESS	Stress model selection flag: 0=disable, 1=classical STI stress model, 2=strained channel stress model	—	1
SWSUBDEP	Flag for substrate depletion model (without=0, with=1)	—	0
TBOX	Buried oxide thickness	m	1e-07
TBOXO	Buried oxide thickness	m	1e-07
THECS	Remote Coulomb scattering exponent at TR	—	1.5
THECSO	Remote Coulomb scattering exponent at TR	—	1.5
THEMU	Front channel mobility reduction exponent at TR	—	1.5
THEMUO	Front channel mobility reduction exponent at TR	—	1.5
THERSG	Transverse electric field dependence exponent of RS	—	2
THERSGO	Transverse electric field dependence exponent of RS	—	2
THESAT	Velocity saturation parameter at TR	V ⁻¹	0
THESATB	Back gate bias dependence of velocity saturation	—	0
THESATBO	Back gate bias dependence of velocity saturation	—	0
THESATG	Front gate bias dependence of velocity saturation	—	0

Table 2-148. L_UTSOI MOSFET Device Model Parameters

Parameter	Description	Units	Default
THESATG0	Front gate bias dependence of velocity saturation	—	0
THESATL	Length dependence of THESAT	—	0
THESATLEXP	Exponent for length dependence of THESAT	—	1
THESATLW	Area dependence of THESAT	—	0
THESATO	Geometry independent velocity saturation parameter at TR	—	0
THESATW	Width dependence of THESAT	—	0
TKUO	Temperature dependence of KUO	—	0
TMAX	Maximum self-heating temperature elevation	C	150
TOXE	Front gate equivalent oxide thickness	m	2e-09
TOXEO	Front gate equivalent oxide thickness	m	2e-09
TOXP	Front gate physical oxide thickness	m	2e-09
TOXPO	Front gate physical oxide thickness	m	2e-09
TR	Nominal temperature	C	21
TSI	Silicon or SiGe film thickness	m	1e-08
TSIO	Silicon or SiGe film thickness	m	1e-08
TYPE	Channel type parameter, +1=NMOS -1=PMOS	—	1
UO	Front channel zero-field mobility at TR	m ² /(Vs)	0.05
VERSION	Model version	—	102.4
VFB	Flat-band voltage of the front gate at TR	V	0
VFBB	Flat-band voltage of the back gate at TR	V	0
VFBB0	Geometry-independent back gate flat-band voltage at TR	V	0
VFBL	Length dependence of VFB	V	0
VFBL2	Second order length dependence of VFB	—	0
VFBLB0	Roll-off back to front interface asymmetry factor	—	0
VFBLEXP	Exponent describing length dependence of VFB	—	2
VFBLEXP2	Exponent of second order length dependence of VFB	—	2
VFBLW	Area dependence of VFB	V	0
VFBO	Geometry-independent front gate flat-band voltage at TR	V	0
VFBW	Width dependence of VFB	V	0
VP	CLM logarithm dependence factor	V	0.05
VPG	Transverse electric field dependence of CLM logarithm factor	—	0
VPGO	Transverse electric field dependence of CLM logarithm factor	—	0

Table 2-148. L_UTSOI MOSFET Device Model Parameters

Parameter	Description	Units	Default
VPO	CLM logarithm dependence factor	V	0.05
WBET	Characteristic width of BETN scaling	m	1e-08
WKUO	Width dependence of KUO	—	0
WKVTHO	Width dependence of KVTHO	—	0
WLOD	Width parameter	m	0
WLODKUO	Width parameter for UO stress effect	—	0
WLODVTH	Width parameter for VTH-stress effect	—	0
WOT	Effective reduction of channel width per side	m	0
WVARL	Length dependence of WOD	—	0
WVARO	Geometry-independent difference between physical and drawn field-oxide opening	m	0
WVARW	Width dependence of WOD	—	0
XCOR	Front channel non-universality factor	—	0
XCORB	Asymmetry term of non-universality factor	—	1
XCORBO	Asymmetry term of non-universality factor	—	1
XCORL	Length dependence of XCOR	—	0
XCORLEXP	Exponent describing length dependence of XCOR	—	1
XCORLW	Area dependence of XCOR	—	0
XCORO	Geometry-independent part of non-universality factor	—	0
XCORW	Width dependence of XCOR	—	0
XGE	Fraction of Ge content in the channel	—	0
XGEO	Fraction of Ge content in the channel	—	0

Table 2-149. MOSFET level 10240 Output Variables

Parameter	Description	Units	Default
type	Flag for channel type		none
vds	Internal drain-source DC voltage (NMOS convention)	V	none
vsb	Internal source-bulk DC voltage (NMOS convention)	V	none
vgs	Internal gate-source DC voltage (NMOS convention)	V	none
vth	Threshold voltage	V	none
vth_drive	Effective gate drive voltage, including back bias, drain bias effects and self-heating	V	none
vdsat	Drain saturation voltage at the given bias	V	none
vdsat_marg	Vds voltage margin	V	none
id	Total DC drain current flowing into drain terminal	A	none

Table 2-149. MOSFET level 10240 Output Variables

Parameter	Description	Units	Default
ig	Total DC gate current flowing into gate terminal	A	none
is	Total DC source current flowing into source terminal	A	none
ib	Total DC bulk current flowing into bulk terminal	A	none
ids	DC channel current, excluding tunnel, GISL and GIDL currents	A	none
igidl	DC Gate Induced Drain Leakage current	A	none
igisl	DC Gate Induced Source Leakage current	A	none
igs	DC gate-source leakage current	A	none
igd	DC gate-drain leakage current	A	none
idb	DC drain-bulk current	A	none
isb	DC source-bulk current	A	none
gm	Internal DC transconductance	A/V	none
gmb	Internal DC bulk transconductance	A/V	none
gds	Internal DC output conductance	A/V	none
cgg	Internal AC gate capacitance, including overlap capacitances	F	none
cgd	Internal AC gate-drain transcapacitance, including overlap capacitances	F	none
cgs	Internal AC gate-source transcapacitance, including overlap capacitances	F	none
cgb	Internal AC gate-bulk transcapacitance	F	none
cdd	Internal AC drain capacitance	F	none
cdg	Internal AC drain-gate transcapacitance	F	none
cds	Internal AC drain-source transcapacitance	F	none
cdb	Internal AC drain-bulk transcapacitance	F	none
cbb	Internal AC bulk capacitance	F	none
cbg	Internal AC bulk-gate transcapacitance	F	none
cbs	Internal AC bulk-source transcapacitance	F	none
cbd	Internal AC bulk-drain transcapacitance	F	none
css	Internal AC source capacitance	F	none
csg	Internal AC source-gate transcapacitance	F	none
csb	Internal AC source-bulk transcapacitance	F	none
csd	Internal AC source-drain transcapacitance	F	none
tk	MOSFET device temperature	K	none
dtsh	MOSFET device temperature increase due to self-heating	K	none
self_gain	Internal L-UTSOI model self gain		none

Table 2-149. MOSFET level 10240 Output Variables

Parameter	Description	Units	Default
rout	AC output resistance	Ohm	none
beff	Gain factor in saturation	A/V ²	none
ft	Unity gain frequency at the given bias	Hz	none
rgate	MOS gate resistance (intrinsic input resistance)	Ohm	none
gmoverid	Gm over Id	1/V	none
vearly	Equivalent Early voltage	V	none

2.3.21. Lossy Transmission Line (LTRA)



Instance Form 0<name> <A port (+) node> <A port (-) node>
 + <B port (+) node> <B port (-) node> [model name]

Model Form .MODEL <model name> LTRA R=<value> L=<value> C=<value>
 + G=<value> LEN=<value> [model parameters]

Examples 0line1 inp inn outp outn cable1
 0line2 inp inn outp outn cable1

Comments The lossy transmission line, or LTRA, device is a two port (A and B), bi-directional device. The (+) and (-) nodes define the polarity of a positive voltage at a port.

R, L, C, and G are the resistance, inductance, capacitance, and conductance of the transmission line per unit length, respectively. LEN is the total length of the transmission line. Supported configurations for the LTRA are RLC, RC, LC (lossless) and RG.

The lossy transmission line, or LTRA, device does not work with AC analysis at this time. LTRA models will need to be replaced with lumped transmission line models (YTRANSLINE) when used in AC analysis. The LTRA models do work correctly in harmonic balance simulation.

Model Parameters

Table 2-150. Lossy Transmission Line Device Model Parameters

Parameter	Description	Units	Default
ABS	Abs. rate of change of deriv. for bkpt	–	1
C	Capacitance per unit length	F/m	0
COMPACTABS	special abstol for straight line checking	–	1e-12
COMPACTREL	special reltol for straight line checking	–	0.001
COMPLEXSTEPCONTROL	do complex time step control using local truncation error estimation	logical (T/F)	false
G	Conductance per unit length	Ω^{-1} m ⁻¹	0
L	Inductance per unit length	Hm ⁻¹	0
LEN	length of line	m	0
LININTERP	use linear interpolation	logical (T/F)	false

Table 2-150. Lossy Transmission Line Device Model Parameters

Parameter	Description	Units	Default
MIXEDINTERP	use linear interpolation if quadratic results look unacceptable	logical (T/F)	false
NOSTEPLIMIT	don't limit timestep size based on the time constant of the line	logical (T/F)	false
QUADINTERP	use quadratic interpolation	logical (T/F)	true
R	Resistance per unit length	Ω/m	0
REL	Rel. rate of change of deriv. for bkpt	-	1
STEPLIMIT	limit timestep size based on the time constant of the line	logical (T/F)	true
TRUNCDONTCUT	don't limit timestep to keep impulse response calculation errors low	logical (T/F)	false
TRUNCNR	use N-R iterations for step calculation in LTRAt trunc	logical (T/F)	false

By default time step limiting is on in the LTRA. This means that simulation step sizes will be reduced if required by the LTRA to preserve accuracy. This can be disabled by setting `NOSTEPLIMIT=1` and `TRUNCDONTCUT=1` on the `.MODEL` line.

The option most worth experimenting with for increasing the speed of simulation is `REL`. The default value of 1 is usually safe from the point of view of accuracy but occasionally increases computation time. A value greater than 2 eliminates all breakpoints and may be worth trying depending on the nature of the rest of the circuit, keeping in mind that it might not be safe from the viewpoint of accuracy. Breakpoints may be entirely eliminated if the circuit does not exhibit any sharp discontinuities. Values between 0 and 1 are usually not required but may be used for setting many breakpoints.

`COMPACTREL` and `COMPACTABS` are tolerances that control when the device should attempt to compact past history. This can significantly speed up the simulation, and reduce memory usage, but can negatively impact accuracy and in some cases may cause problems with the nonlinear solver. In general this capability should be used with linear type signals, such as square-wave-like voltages. In order to activate this capability the general device option `TRYTOCOMPACT=1` must be set, if it is not no history compaction will be performed and the `COMPACT` options will be ignored.

Example:

```
.OPTIONS DEVICE TRYTOCOMPACT=1
```

References See references [33] and [34] for more information about the model.

2.3.22. Voltage- or Current-controlled Switch

Instance Form S<name> <(+) switch node> <(-) switch node>
 + <(+) control node> <(-) control node>
 + <model name> [ON] [OFF]

 W<name> <(+) switch node> <(-) switch node>
 + <control node voltage source>
 + <model name> [ON] [OFF]

Model Form .MODEL <model name> VSWITCH [model parameters]
 .MODEL <model name> ISWITCH [model parameters]

Examples S1 21 23 12 10 SMOD1
 SSET 15 10 1 13 SRELAY
 W1 1 2 VCLOCK SWITCHMOD1
 W2 3 0 VRAMP SM1 ON

Comments The voltage- or current-controlled switch is a particular type of controlled resistor. This model is designed to help reduce numerical issues. See Special Considerations below.

 The resistance between the <(+) switch node> and the <(-) switch node> is dependent on either the voltage between the <(+) control node> and the <(-) control node> or the current through the control node voltage source. The resistance changes in a continuous manner between the RON and ROFF model parameters.

 No resistance is inserted between the control nodes. It is up to the user to make sure that these nodes are not floating.

 Hysteresis in the switching behavior of the device can be controlled with the model parameters IHON, IHOFF, VHON and IVOFF for current and voltage controlled switches respectively. For a general switch that is dependent on an expression hysteresis can be set with the model parameters vONH and OFFH. If none of these parameters are set then hysteresis is will not be used for the device.

 Even though evaluating the switch model is computationally inexpensive, for transient analysis Xyce steps through the transition section using small time-steps in order to calculate the waveform accurately. Thus, a circuit with many switch transitions can result in lengthy run times.

 The ON and OFF parameters are used to specify the initial state of the switch at the first step of the operating point calculation; this does not force the switch to be in that state, it only gives the operating point solver an initial state to work with. If it is known that the switch should be in a particular state in the operating point it could help convergence to specify one of these keywords.

The power dissipated in the switch is calculated with $I \cdot \Delta V$ where the voltage drop is calculated as $(V_+ - V_-)$ and positive current flows from V_+ to V_- . This will essentially be the power dissipated in either RON or ROFF, since the switch is a particular type of controlled resistor.

Note: The voltage- and current-controlled switches specified in this manner are converted at parse time into equivalent “generic” switches.

Model Parameters

Table 2-151. Controlled Switch Device Model Parameters

Parameter	Description	Units	Default
IHOFF	Off current	A	0
IHON	On current with hysteresis	A	0.001
IOFF	Off current with hysteresis	A	0
ION	On current	A	0.001
OFF	Off control value	–	0
OFFH	Off control value with hysteresis	–	0
ON	On control value	–	1
ONH	On control value with hysteresis	–	1
ROFF	Off resistance	Ω	1e+06
RON	On resistance	Ω	1
VHOFF	Off voltage with hysteresis	V	0
VHON	On voltage with hysteresis	V	1
VOFF	Off voltage	V	0
VON	On voltage	V	1

Special Considerations

- Due to numerical limitations, Xyce can only manage a dynamic range of approximately 12 decades. Thus, it is recommended the user limit the ratio **ROFF/RON** to less than 10^{12} . This soft limitation is not enforced by the code, and larger ratios might converge for some problems.
- Do not set **RON** to 0.0, as the code computes the “on” conductance as the inverse of **RON**. Using 0.0 will cause the simulation to fail when this invalid division results in an infinite conductance. Use a very small, but non-zero, on resistance instead.
- Furthermore, it is a good idea to limit the narrowness of the transition region. This is because in the transition region, the switch has gain and the narrower the region, the higher the gain and the more potential for numerical problems. The smallest value recommended for $\|VON - VOFF\|$ or $\|ION - IOFF\|$ is 1×10^{-12} . This recommendation is not a restriction, and you might find for some problems that narrower transition regions might work well.

Controlled switch equations The equations in this section use the following variables:

$$\begin{aligned}
 R_s &= \text{switch resistance} \\
 V_c &= \text{voltage across control nodes} \\
 I_c &= \text{current through control node voltage source} \\
 L_m &= \text{log-mean of resistor values} &= \ln \left(\sqrt{RON \cdot ROFF} \right) \\
 L_r &= \text{log - ratio of resistor values} &= \ln (RON/ROFF) \\
 V_d &= \text{difference of control voltages} &= VON - VOFF \\
 I_d &= \text{difference of control currents} &= ION - IOFF
 \end{aligned}$$

Switch Resistance To compute the switch resistance, Xyce first calculates the “switch state” S as $S = (V_c - \mathbf{VOFF})/V_d$ or $S = (I_c - \mathbf{IOFF})/I_d$. The switch resistance is then:

$$R_s = \begin{cases} \mathbf{RON}, & S \geq 1.0 \\ \mathbf{ROFF}, & S \leq 0.0 \\ \exp(L_m + 0.75L_r(2S - 1) - 0.25L_r(2S - 1)^3), & 0 < S < 1 \end{cases}$$

2.3.23. Generic Switch

Instance Form S<name> <(+) switch node> <(-) switch node> <model name> [ON]
 [OFF] <control = expression >

Model Form .MODEL <model name> VSWITCH [model parameters]
 .MODEL <model name> ISWITCH [model parameters]
 .MODEL <model name> SWITCH [model parameters]

Examples S1 1 2 SWI OFF CONTROL={I(VMON)}
 SW2 1 2 SWV OFF CONTROL={V(3)-V(4)}
 S3 1 2 SW OFF CONTROL={if(time>0.001,1,0)}

Comments The generic switch is similar to the voltage- or current-controlled switch except that the control variable is anything that can be written as an expression. The examples show how a voltage- or current-controlled switch can be implemented with the generic switch. Also shown is a relay that turns on when a certain time is reached. Model parameters are given in Table 2-151.

The voltage- and current-controlled switch syntaxes are converted at parse time to their equivalent generic device, and so all three variants in fact use the same code internally.

Hysteresis in the switching behavior of the device can be controlled with the model parameters IHON, IHOFF, VHON and IVOFF for current and voltage controlled switches respectively. For a general switch that is dependent on an expression hysteresis can be set with the model parameters vONH and OFFH. If none of these parameters are set then hysteresis is will not be used for the device.

The power dissipated in the generic switch is calculated with $I \cdot \Delta V$ where the voltage drop is calculated as $(V_+ - V_-)$ and positive current flows from V_+ to V_- . This will essentially be the power dissipated in either RON or ROFF, since the generic switch is a particular type of controlled resistor.

2.3.24. Linear device

The linear (YLIN) device allows an S-, Y-, or Z-parameter model to be used to define an N-port device. It is most commonly used as part of a Harmonic Balance (HB) analysis.

Instance Form YLIN <name> <(+) node> <(-) node> [model name]

Model Form .MODEL <model name> LIN [model parameters]

Examples YLIN YLIN1 1 0 2 0 YLIN_MOD1
 .MODEL YLIN_MOD1 LIN TSTONEFILE=yparams.y2p

Parameters and Options **model name**
 Name of the model defined in a .MODEL line.

Comments At present, the YLIN device is only supported in the frequency domain for HB analyses.

Model Parameters

Table 2-152. LIN Device Model Parameters

Parameter	Description	Units	Default
ISC_FD	Touchstone file contains frequency-domain short-circuit current data	logical (T/F)	false
TSTONEFILE	Touchstone File Name	–	”
INTERPOLATION	Interpolation method. Supported methods: <ul style="list-style-type: none"> • 1 (linear) • 2 (akima spline) 	–	1
HIGHPASS	Extrapolation method for higher frequency points. Supported methods: <ul style="list-style-type: none"> • 0 (cut off) • 1 (use highest frequency point) • 2 (linear extrapolation using highest 2 points) 	–	1

Table 2-152. LIN Device Model Parameters

Parameter	Description	Units	Default
LOWPASS	Extrapolation method for lower frequency points. Supported methods: <ul style="list-style-type: none">• 0 (cut off)• 1 (use lowest frequency point)• 2 (linear extrapolation using lowest 2 points)	–	1

The Touchstone file name must be specified. The YLIN device accepts both Touchstone 1 and Touchstone 2 formatted input files [7].

For coupling with EM codes, such as EIGER, the YLIN device also accepts a non-standard version of the Touchstone input files. If the ISC_FD model parameter is set to true then each row of “network data” in the input file also contains additional columns with the “per-port frequency-domain short-circuit currents”. There are then two such additional columns for each port. The format (RI, MA or DB) of those additional columns will be as specified by the Option line in the Touchstone file. In this non-standard case, only the “Full” matrix format is supported for Touchstone 2 input files.

2.3.25. Lossless (Ideal) Transmission Line

Symbol	
Instance Form	<pre>T<name> <port 1 (+) node> <port 1 (-) node> + <port 2 (+) node> <port 2 (-) node> + Z0=<value> [TD=<value>] [F=<value> [NL=<value>]]</pre>
Examples	<pre>Tline inp inn outp outn Z0=50 TD=1us Tline2 inp inn outp outn Z0=50 F=1meg NL=1.0</pre>
Comments	<p>The lossless transmission line device is a two port (A and B), bi-directional delay line. The (+) and (-) nodes define the polarity of a positive voltage at a port.</p> <p>Z0 is the characteristic impedance. For user convenience, Z0 (“Zee Oh”) is an allowed synonym for Z0 (“Zee Zero”).</p> <p>The transmission line’s length is specified by either TD (a delay in seconds) or by the combination of F and NL (a frequency in Hz and the relative wavelength at F). NL defaults to 0.25 (F is the quarter-wave frequency). If F is given, the time delay is computed as $\frac{NL}{F}$.</p> <p>While both TD and F are optional, at least one of them must be given. It is an instance line error if both are given.</p> <p>Lead currents for the two terminals (1 and 2) of the lossless transmission device (e.g., for the T device line2) are accessed via I1(Tline2) and I2(Tline2). The polarity conventions are that positive current flows into the positive node of the specified terminal, and negative current flows out of the positive node of the specified terminal.</p> <p>Power for the lossless transmission line is calculated as $I_1 \cdot \Delta V_1 + I_2 \cdot \Delta V_2$, where the voltage drops (ΔV_1 and ΔV_2) are the voltage drops between the positive and negative terminals of each port (e.g., $\Delta V = (V_+ - V_-)$). The sign conventions for the lead currents I_1 and I_2 were given in the previous paragraph. This definition can be viewed as the instantaneous sum of the power flowing into terminal 1 and the power flowing into terminal 2. This definition for power for the lossless transmission line may differ from commercial simulators, such as HSPICE.</p> <p>The lossless transmission line device does not work with AC analysis at this time. Lossless transmission line models will need to be replaced with lumped transmission line models (YTRANSLINE) when used in AC analysis. The lossless transmission line does work correctly in harmonic balance simulation.</p>

Instance Parameters

Table 2-153. Ideal Transmission Line Device Instance Parameters

Parameter	Description	Units	Default
F	Frequency	Hz	0
NL	Length in wavelengths	–	0.25
TD	Time delay	s	0
Z0	Characteristic Impedance	Ω	0
Z0	Characteristic Impedance	Ω	0

2.3.26. Lumped Transmission Line

Symbol	
Instance Form	<code>ytransline <name> <Input port> <Output port> testLine + len=<value> lumps=<value></code>
Model Form	<code>.model testLine transline r=<value> l=<value> + c=<value> [model parameters]</code>
Examples	<code>ytransline line1 inn out testLine len=12.0 lumps=1440</code>
Comments	<p>The lumped transmission line, device is a two port bi-directional device. The specification is patterned, loosely, from the netlist specification for the LTRA device.</p> <p>R, L, and C are the resistance, inductance, and capacitance of the transmission line per unit length, respectively. LEN is the total length of the transmission line, and LUMPS is the number of lumped elements used to discretize the line. Supported configurations for this device are RLC and LC.</p> <p>Unlike the LTRA device, which is based on an analytic solution, this device is based on assembling chains of linear R,L and C devices to approximate the solution to the Telegraph equations. It is the functional equivalent of building a transmission line in the netlist using subcircuits of linear elements. The advantage of using this approach is that it automates the mechanics of this process, and thus is less prone to error. It can be used with all analysis types, including harmonic balance (HB).</p> <p>The model is based on the assumption that the segments of the line are evenly spaced. The number of segments is specified by the parameter LUMPS and the larger this number, the more accurate the calculation.</p>

Device Parameters

Table 2-154. Lumped Transmission Line Device Instance Parameters

Parameter	Description	Units	Default
LEN	length of line	m	0
LUMPS		-	1

Model Parameters

Table 2-155. Lumped Transmission Line Device Model Parameters

Parameter	Description	Units	Default
C	Capacitance per unit length	F/m	0
ELEV		–	2
G	Conductance per unit length	$\frac{\Omega^{-1}}{m^{-1}}$	0
L	Inductance per unit length	Hm^{-1}	0
R	Resistance per unit length	Ω/m	0

2.3.27. Ideal Delay

An ideal delay device, operating in a manner similar to a voltage-controlled voltage source, is provided by the YDELAY device.

Instance Form YDELAY <name> <positive node> <negative node>
 + <positive control node> <negative control node>
 + TD=<time delay>
 + [EXTRAPOLATION=<true|false>] [BPENABLED=<true|false>]
 + [LINEARINTERP=<true|false>]

Examples

```
YDELAY delay1 2 0 1 0 TD=10N
R1 2 0 1
YDELAY delay1 3 0 2 0 TD=10N LINEARINTERP=true
R2 3 0 1
YDELAY delay1 4 0 3 0 TD=10N BPENABLED=FALSE
R4 4 0 1
YDELAY delay1 5 0 4 0 TD=10N EXTRAPOLATION=false
R5 5 0 1
```

Comments

The voltage between the positive and negative control nodes is reproduced at the positive and negative output nodes delayed by a time equal to the specified TD parameter.

The device is equivalent in connectivity to a voltage-controlled voltage source — the device puts no load on the control nodes, and its output must be connected to a valid circuit.

Unlike the transmission line, no impedance matching is required, and reflections due to impedance mismatch do not occur.

These devices may be chained to create outputs at different delays, but each instance must have its output connected to a valid closed circuit. The examples above are chained correctly so that each of the output nodes is delayed by 10 nanoseconds from the previous stage.

The device functions by storing a history of its input at each accepted time point. At each new time step, interpolation is performed on this history to determine what the signal would have been at a time TD in the past. At each step, the device checks its history to determine if the previous three saved steps include a discontinuity in the input. If so, the device assures that Xyce will correctly resolve the same discontinuity when it appears on the output.

With no special options specified, three-point quadratic interpolation is used except after a discontinuity, when linear interpolation is performed. If Xyce has advanced the time by more than TD and no discontinuity has occurred, then this interpolation is actually extrapolation.

When `LINEARINTERP=true` is specified, the history interpolation used is always linear interpolation.

When `EXTRAPOLATION=false`, Xyce will never attempt extrapolation when it has taken a time step larger than TD. In this case, the current, unconverged value of the solution is used as the third interpolation point and the interpolation is recomputed at every step of the nonlinear solve.

When `BPENABLED=false`, the device will not set a simulation breakpoint to force the time integrator to stop exactly TD seconds after a detected discontinuity on the input. It will still force a maximum time step on the time integrator after such a discontinuity, and other techniques will be applied to assure the discontinuity is resolved. This option may result in Xyce rejecting a lot more time steps and slower simulation than when it is left at its default.

2.3.27.1. Delay device instance parameters

The instance parameters for the delay device are shown in Table 2-156.

Table 2-156. Delay element Device Instance Parameters

Parameter	Description	Units	Default
BPENABLED	Can this device set discontinuity breakpoints?	–	true
EXTRAPOLATION	Can this device use extrapolation on history?	–	true
LINEARINTERP	Should this device use only linear interpolation on history?	–	false
TD	Time delay	s	0

2.3.28. Behavioral Digital Devices

Instance Form U<name> <type>(<num inputs>) [digital power node]
 + [digital ground node] <input node>* <output node>*
 + <model name> [device parameters]

Model Form .MODEL <model name> DIG [model parameters]

Examples UMYAND AND(2) DPWR DGND in1 in2 out DMOD IC=TRUE
 UTHEINV INV DPWR DGND in out DMOD
 .model DMOD DIG (
 + CLO=1e-12 CHI=1e-12
 + SORLO=5 SORHI=5 SOTSW=5e-9
 + SOVLO=-1 SOVHI=1.8
 + S1RLO=200 S1RHI=5 S1TSW=5e-9
 + S1VLO=1 S1VHI=3
 + RLOAD=1000
 + CLOAD=1e-12
 + DELAY=20ns)

Parameters and Options

type

Type of digital device. Supported devices are: INV, BUF, AND, NAND, OR, NOR, XOR, NXOR, DFF, JKFF, TFF, DLTCH and ADD. (Note: NOT is an allowed synonym for INV, but will be deprecated in future Xyce releases.)

The following gates have a fixed number of inputs. INV and BUF have only one input and one output node. XOR and NXOR have two inputs and one output. ADD has three inputs (in1, in2, carryIn) and two outputs (sumOut and carryOut). DFF has four inputs (PREB, CLRB, Clock and Data) and two outputs (Q and \bar{Q}). TFF has two inputs (T and CLK) and two outputs (Q and \bar{Q}). The TFF uses “positive” (“rising”) edge clocking. The JKFF has five inputs (PREB, CLRB, Clock, J and K) and two outputs (Q and \bar{Q}). The JKFF uses “negative” (“falling”) edge clocking. DLTCH has four inputs (PREB, CLRB, Enable and Data) and two outputs (Q and \bar{Q}).

The AND, NAND, OR and NOR gates have one output but a variable number of inputs. There is no limit on the number of inputs for AND, NAND, OR and NOR gates, but there must be at least two inputs.

num inputs

For AND, NAND, OR and NOR gates, with N inputs, the syntax is (N), as shown for the MYAND example given above, where AND(2) is specified. The inclusion of (N) is mandatory for gates with a variable number of inputs, and both the left and right parentheses must be used to enclose N.

This parameter is optional, and typically omitted, for gates with a fixed number of inputs, such as INV, BUF, XOR, NXOR, DFF, JKFF, TFF,

DLTCH and ADD. This is illustrated by the THEINV example given above, where the device type is INV rather than INV(1).

digital power node

Dominant node to be connected to the output node(s) to establish high output state. This node is connected to the output by a resistor and capacitor in parallel, whose values are set by the model. This node must be specified on the instance line.

digital ground node

This node serves two purposes, and must be specified on the instance line. It is the dominant node to be connected to the output node(s) to establish low output state. This node is connected to the output by a resistor and capacitor in parallel, whose values are set by the model. This node is also connected to the input node by a resistor and capacitor in parallel, whose values are set by the model. Determination of the input state is based on the voltage drop between the input node and this node.

input nodes, output nodes

Input and output nodes that connect to the circuit.

model name

Name of the model defined in a .MODEL line.

device parameters

Parameter listed in Table 2-157 may be provided as <parameter>=<value> specifications as needed. For devices with more than one output, multiple output initial states may be provided as Boolean values in either a comma separated list (e.g. IC=TRUE,FALSE for a device with two outputs) or individually (e.g. IC1=TRUE IC2=FALSE or IC2=FALSE). Finally, the IC specification must use TRUE and FALSE rather than T and F.

Device Parameters

Table 2-157. Behavioral Digital Device Instance Parameters

Parameter	Description	Units	Default
IC1	Vector of initial values for output(s)	logical (T/F)	false
IC2		–	false

Model Parameters

Table 2-158. Behavioral Digital Device Model Parameters

Parameter	Description	Units	Default
CHI	Capacitance between output node and high reference	F	1e-06
CLO	Capacitance between output node and low reference	F	1e-06
CLOAD	Capacitance between input node and input reference	F	1e-06

Table 2-158. Behavioral Digital Device Model Parameters

Parameter	Description	Units	Default
DELAY	Delay time of device	s	1e-08
RLOAD	Resistance between input node and input reference	Ω	1000
S0RHI	Low state resistance between output node and high reference	Ω	100
S0RLO	Low state resistance between output node and low reference	Ω	100
S0TSW	Switching time transition to low state	s	1e-08
S0VHI	Maximum voltage to switch to low state	V	1.7
S0VLO	Minimum voltage to switch to low state	V	-1.5
S1RHI	High state resistance between output node and high reference	Ω	100
S1RLO	High state resistance between output node and low reference	Ω	100
S1TSW	Switching time transition to high state	s	1e-08
S1VHI	Maximum voltage to switch to high state	V	7
S1VLO	Minimum voltage to switch to high state	V	0.9

Model Description The input interface model consists of the input node connected with a resistor and capacitor in parallel to the digital ground node. The values of these are: **RLOAD** and **CLOAD**.

The logical state of any input node is determined by comparing the voltage relative to the reference to the range for the low and high state. The range for the low state is **S0VLO** to **S0VHI**. Similarly, the range for the high state is **S1VLO** to **S1VHI**. The state of an input node will remain fixed as long as its voltage stays within the range for its current state. That input node will transition to the other state only when its state goes outside the voltage range of its current state.

The output interface model is more complex than the input model, but shares the same basic configuration of a resistor and capacitor in parallel to simulate loading. For the output case, there are such parallel RC connections to two nodes, the digital ground node and the digital power node. Both of these nodes must be specified on the instance line.

The capacitance to the high node is specified by **CHI**, and the capacitance to the low node is **CLO**. The resistors in parallel with these capacitors are variable, and have values that depend on the state. In the low state (S0), the resistance values are: **S0RLO** and **S0RHI**. In the high state (S1), the resistance values are: **S1RLO** and **S1RHI**. Transition to the high state occurs exponentially over a time of **S1TSW**, and to the low state **S0TSW**.

The device's delay is given by the model parameter **DELAY**. Any input changes that affect the device's outputs are propagated after this delay.

As a note, the model parameters **VREF**, **VLO** and **VHI** are used by the now deprecated Y-type digital device, but are ignored by the U device. A warning message is emitted if any of these three parameters are used in the model card for a U device.

Another caveat is that closely spaced input transitions to the Xyce digital behavioral models may not be accurately reflected in the output states. In particular, input-state changes spaced by more than DELAY seconds have independent effects on the output states. However, two input-state changes (S1 and S2) that occur within DELAY seconds (e.g., at time=t1 and time=t1+0.5*DELAY) have the effect of masking the effects of S1 on the device’s output states, and only the effects of S2 are propagated to the device’s output states.

DCOP Calculations for Flip-Flops and Latches The behavior of the digital devices during the DC Operating Point (DCOP) calculations can be controlled via the IC1 and IC2 instance parameters and the DIGINITSTATE device option. See 2.1.25 for more details on the syntax for device options. Also, this section applies to the Y-Type Behavioral Digital Devices discussed in 2.3.29.

The IC1 instance parameter is supported for all gate types. The IC2 instance parameter is supported for all gate types that have two outputs. These instance parameters allow the outputs of individual gates to be set to known states (either TRUE (1) or FALSE (0)) during the DCOP calculation, irregardless of their input state(s). There are two caveats. First, the IC1 and IC2 settings at a given gate will override the global effects of the DIGINITSTATE option, discussed below, at that gate. Second, IC1 and IC2 do not support the X, or “undetermined”, state discussed below.

The DIGINITSTATE option only applies to the DLTCH, DFF, JKFF and TFF devices. It was added for improved compatibility with PSpice. It sets the initial state of all flip-flops and latches in the circuit: 0=clear, 1=set, 2=X. At present, the use of the DIGINITSTATE option during the DCOP is the only place that Xyce supports the X, or “undetermined”, state. The X state is modeled in Xyce by having the DLTCH, DFF, JKFF and TFF outputs simultaneously “pulled-up” and “pulled-down”. That approach typically produces an output level, for the X state, that is approximately halfway between the voltage levels for TRUE and FALSE (e.g., halfway between V_HI and V_LO). As mentioned above, the IC1 and IC2 instance parameters take precedence at a given gate.

Xyce also supports a default DIGINITSTATE, whose value is 3. For this default value, for the DFF, JKFF, TFF and DLTCH devices, Xyce enforces Q and \bar{Q} being different at DCOP, if both PREB and CLRB are TRUE. The behavior of the DFF, JKFF and DLTCH devices at the DCOP for DIGINITSTATE=3 is shown in Tables 2-159, 2-161 and 2-160. In these three tables, the X state denotes the “Don’t Care” condition, where the input state can be 0, 1 or the “undetermined” state. The first row in each truth-table (annotated with *) is “unstable”, and will change to a state with Q and \bar{Q} being different once both PREB and CLRB are not both in the FALSE state.

The behavior of the TFF device at the DCOP, for the default DIGINITSTATE of 3, is simpler, and is not shown as a table. The design decision was to have Q and \bar{Q} be different, with the Q value equal to the state of the T input.

Table 2-159. DFF Truth-Table for DIGINITSTATE=3

PREB	CLRB	CLOCK	DATA	Q	\bar{Q} (Qbar)
0	0	X	X	1*	1*
0	1	X	X	1	0
1	0	X	X	0	1
1	1	X	0	0	1
1	1	X	1	1	0

Table 2-160. DLTCH Truth-Table for DIGINITSTATE=3

PREB	CLRB	ENABLE	DATA	Q	\bar{Q} (Qbar)
0	0	X	X	1*	1*
0	1	X	X	1	0
1	0	X	X	0	1
1	1	X	0	0	1
1	1	X	1	1	0

Table 2-161. JKFF Truth-Table for DIGINITSTATE=3

PREB	CLRB	CLOCK	J	K	Q	\bar{Q} (Qbar)
0	0	X	X	X	1*	1*
0	1	X	X	X	1	0
1	0	X	X	X	0	1
1	1	X	0	X	0	1
1	1	X	1	X	1	0

2.3.29. Y-Type Behavioral Digital Devices (Deprecated)

Instance Form Y<type> <name> [low output node] [high output node]
+ [input reference node] <input node>* <output node>*
+ <model name> [device parameters]

Model Form .MODEL <model name> DIG [model parameters]

Examples

```
YAND MYAND in1 in2 out DMOD IC=TRUE
YNOT THENOT in out DMOD
YNOR ANOR2 vlo vhi vref in1 in2 out DDEF
.model DMOD DIG (
+ CLO=1e-12 CHI=1e-12
+ SORLO=5 SORHI=5 SOTSW=5e-9
+ SOVLO=-1 SOVHI=1.8
+ S1RLO=200 S1RHI=5 S1TSW=5e-9
+ S1VLO=1 S1VHI=3
+ RLOAD=1000
+ CLOAD=1e-12
+ VREF=0 VLO=0 VHI=3
+ DELAY=20ns )
.MODEL DDEF DIG
```

Parameters and Options

type

Type of digital device. Supported devices are: NOT, BUF, AND, NAND, OR, NOR, XOR, NXOR, DFF, JKFF, TFF, DLTCH and ADD. (Note: INV is now the preferred synonym for NOT. The NOT device type will be deprecated in future Xyce releases.) For Y-type digital devices, all devices have two input nodes and one output node, except for NOT, DFF and ADD. NOT has one input and one output. ADD has three inputs (in1, in2, carryIn) and two outputs (sumOut and carryOut). DFF has four inputs (PREB, CLRB, Clock and Data) and two outputs (Q and \bar{Q}). TFF has two inputs (T and Clock) and two outputs (Q and \bar{Q}). The TFF uses “positive” (“rising”) edge clocking. The JKFF has five inputs (PREB, CLRB, Clock, J and K) and two outputs (Q and \bar{Q}). The JKFF uses “negative” (“falling”) edge clocking. DLTCH has four inputs (PREB, CLRB, Enable and Data) and two outputs (Q and \bar{Q}).

name

Name of the device instance. This must be present, and when combined with the Y<type>, must be unique in the netlist. In the examples, MYAND, THENOT and ANOR2 have been used as names for the three devices.

low output node

Dominant node to be connected to the output node(s) to establish low output state. This node is connected to the output by a resistor and capacitor in

parallel, whose values are set by the model. If specified by the model, this node must be omitted from the instance line and a fixed voltage **VLO** is used instead.

high output node

Dominant node to be connected to the output node(s) to establish high output state. This node is connected to the output by a resistor and capacitor in parallel, whose values are set by the model. If specified by the model, this node must be omitted from the instance line and a fixed voltage **VHI** is used instead.

input reference node

This node is connected to the input node by a resistor and capacitor in parallel, whose values are set by the model. Determination if the input state is based on the voltage drop between the input node and this node. If specified by the model, this node must be omitted from the instance line and a fixed voltage **VREF** is used instead.

input nodes, output nodes

Nodes that connect to the circuit.

model name

Name of the model defined in a .MODEL line.

device parameters

Parameter listed in Table 2-162 may be provided as <parameter>=<value> specifications as needed. For devices with more than one output, multiple output initial states may be provided as Boolean values in either a comma separated list (e.g. IC=TRUE,FALSE for a device with two outputs) or individually (e.g. IC1=TRUE IC2=FALSE or IC2=FALSE). Finally, the IC specification must use TRUE and FALSE rather than T and F.

Device Parameters

Table 2-162. Behavioral Digital Device Instance Parameters

Parameter	Description	Units	Default
IC1	Vector of initial values for output(s)	logical (T/F)	false
IC2		–	false

Model Parameters

Table 2-163. Behavioral Digital Device Model Parameters

Parameter	Description	Units	Default
CHI	Capacitance between output node and high reference	F	1e-06
CLO	Capacitance between output node and low reference	F	1e-06
CLOAD	Capacitance between input node and input reference	F	1e-06

Table 2-163. Behavioral Digital Device Model Parameters

Parameter	Description	Units	Default
DELAY	Delay time of device	s	1e-08
RLOAD	Resistance between input node and input reference	Ω	1000
S0RHI	Low state resistance between output node and high reference	Ω	100
S0RLO	Low state resistance between output node and low reference	Ω	100
S0TSW	Switching time transition to low state	s	1e-08
S0VHI	Maximum voltage to switch to low state	V	1.7
S0VLO	Minimum voltage to switch to low state	V	-1.5
S1RHI	High state resistance between output node and high reference	Ω	100
S1RLO	High state resistance between output node and low reference	Ω	100
S1TSW	Switching time transition to high state	s	1e-08
S1VHI	Maximum voltage to switch to high state	V	7
S1VLO	Minimum voltage to switch to high state	V	0.9
VHI	Internal high state supply voltage	V	0
VLO	Internal low state supply voltage	V	0
VREF	Internal reference voltage for inputs	V	0

Model Description The input interface model consists of the input node connected with a resistor and capacitor in parallel to the digital ground node. The values of these are: **RLOAD** and **CLOAD**.

The logical state of any input node is determined by comparing the voltage relative to the reference to the range for the low and high state. The range for the low state is **S0VLO** to **S0VHI**. Similarly, the range for the high state is **S1VLO** to **S1VHI**. The state of an input node will remain fixed as long as its voltage stays within the voltage range for its current state. That input node will transition to the other state only when its state goes outside the range of its current state.

The output interface model is more complex than the input model, but shares the same basic configuration of a resistor and capacitor in parallel to simulate loading. For the output case, there are such connections to two nodes, the digital ground node and the digital power node. Both of these nodes must be specified on the instance line.

The capacitance to the high node is specified by **CHI**, and the capacitance to the low node is **CLO**. The resistors in parallel with these capacitors are variable, and have values that depend on the state. In the low state (S0), the resistance values are: **S0RLO** and **S0RHI**. In the high state (S1), the resistance values are: **S1RLO** and **S1RHI**. Transition to the high state occurs exponentially over a time of **S1TSW**, and to the low state **S0TSW**.

The device's delay is given by the model parameter **DELAY**. Any input changes that affect the device's outputs are propagated after this delay.

Another caveat is that closely spaced input transitions to the Xyce digital behavioral models may not be accurately reflected in the output states. In particular, input-state changes spaced by more than DELAY seconds have independent effects on the output states. However, two input-state changes (S1 and S2) that occur within DELAY seconds (e.g., at time=t1 and time=t1+0.5*DELAY) have the effect of masking the effects of S1 on the device's output states, and only the effects of S2 are propagated to the device's output states.

DCOP Calculations for Flip-Flops and Latches The behavior of the digital devices during the DC Operating Point (DCOP) calculations can be controlled via the IC1 and IC2 instance parameters and the DIGINITSTATE device option. See 2.3.28 and 2.1.25 for more details on these instance parameters and device option.

Converting Y-Type Digital Devices to U-Type Digital Devices Xyce is migrating the digital behavioral devices to U devices. The goal is increased compatibility with PSpice netlists. This subsection gives four examples of how to convert an existing Xyce netlist using Y-type digital devices to the corresponding U device syntaxes. The conversion process depends on whether the device has a fixed number of inputs or a variable number of inputs. In all cases, the the model parameters **VREF**, **VLO** and **VHI** should be omitted from the U device model card. For U devices, the nodes **vlo** and **vhi** are always specified on the instance line.

Example 1: Fixed number of inputs, Y-device model card contains **VREF**, **VLO** and **VHI**. Assume **VREF=VLO**.

```
YNOT THENOT in out DMOD
.model DMOD DIG (
+ CLO=1e-12 CHI=1e-12
+ SORLO=5 SORHI=5 SOTSW=5e-9
+ SOVLO=-1 SOVHI=1.8
+ S1RLO=200 S1RHI=5 S1TSW=5e-9
+ S1VLO=1 S1VHI=3
+ RLOAD=1000
+ CLOAD=1e-12
+ VREF=0 VLO=0 VHI=3
+ DELAY=20ns )
```

* Digital power node. Assume digital ground node = GND

```
V1 DPWR 0 3V
UTHENOT INV DPWR 0 in out DMOD1
.model DMOD1 DIG (
+ CLO=1e-12 CHI=1e-12
+ SORLO=5 SORHI=5 SOTSW=5e-9
+ SOVLO=-1 SOVHI=1.8
+ S1RLO=200 S1RHI=5 S1TSW=5e-9
+ S1VLO=1 S1VHI=3
+ RLOAD=1000
+ CLOAD=1e-12
+ DELAY=20ns )
```

Example 2: Fixed number of inputs, Y-device instance line contains **vlo**, **vhi** and **vref**. Assume **vref=vlo**.

```
YNOT THENOT vlo vhi vref in out DMOD1
UTHENOT INV vhi vlo in out DMOD1
```

Example 3: Variable number of inputs, Y-device model card contains **VREF**, **VLO** and **VHI**. Assume **VREF=VLO**.

```
YAND MYAND in1 in2 out DMOD
UMYAND AND(2) DPWR 0 in1 in2 out DMOD1
```

Example 4: Variable number of inputs, Y-device instance line contains **vlo**, **vhi** and **vref**. Assume **vref=vlo**.

```
YAND MYAND vlo vhi vref in1 in2 out DMOD1
UMYAND AND(2) vhi vlo in1 in2 out DMOD1
```

2.3.30. Accelerated mass

Simulation of electromechanical devices or magnetically driven machines may require that Xyce simulate the movement of an accelerated mass, that is, to solve the second order initial value problem

$$\begin{aligned}\frac{d^2x}{dt^2} &= a(t) \\ x(0) &= x_0 \\ \dot{x}_0 &= v_0\end{aligned}$$

where x is the position of the object, \dot{x} its velocity, and $a(t)$ the acceleration. In Xyce, this simulation capability is provided by the accelerated mass device.

Instance Form YACC <name> <acceleration node> <velocity node> <position node>
+ [v0=<initial velocity>] [x0=<initial position>]

Examples

```
* Simulate a projectile thrown upward against gravity
V1 acc 0 -9.8
R1 acc 0 1
YACC acc1 acc vel pos v0=10 x0=0
.print tran v(pos)
.tran 1u 10s
.end

* Simulate a damped, forced harmonic oscillator
* assuming K, c, mass, amplitude and frequency
* are defined in .param statements
B1 acc 0 V={(-K * v(pos) - c*v(vel))/mass
+          + amplitude*sin(frequency*TIME)}
R1 acc 0 1
YACC acc2 acc vel pos v0=0 x0=0.4
.print tran v(pos)
.tran 1u 10s
.end
```

Comments When used as in the examples, Xyce will emit warning messages about the pos and vel nodes not having a DC path to ground. This is normal and should be ignored. The position and velocity nodes should not be connected to any real circuit elements. Their values may, however, be used in behavioral sources; this is done in the second example.

2.3.31. Power Grid

The Power Grid devices are a family of device models that can be used to model steady-state power flow in electric power grids. They include device models for branches, bus shunts, transformers and generator buses.

Power flow in electric power grids can be modeled as a complex-valued voltage-current problem with standard admittance-matrix techniques. This approach solves the system of equations $I = YV$, and is termed IV format in this document. However, it is more typically modeled as a power-flow problem that solves the system of equations $S = P + jQ = VI^*$, where S is the complex power flow, V and I are complex-valued quantities, and I^* is the complex conjugate of I . The complex power flow can then be solved in either rectangular or polar coordinates. These two solution formats are termed PQ Rectangular (aka, PQR format) and PQ Polar (aka, PQP format) in this document. The variables for each solution format are described in more detail in the device descriptions given below.

In all three formulations, an Equivalent Real Formulation (ERF) [35] must be used for compatibility with the existing solver libraries in Xyce. More details on these equations are given below after the individual device descriptions.

PowerGridBranch

Instance Form Y<type> <name> <input node1> <output node1>
 + <input node2> <output node2> [device parameters]

Examples YPowerGridBranch pg1_2 VR1 VR2 VI1 VI2 AT=IV R=0.05 B=0.1 X=0.05
 YPGBR pg1_2a VR1 VR2 VI1 VI2 AT=IV R=0.05 B=0.1 X=0.05
 YPowerGridBranch pg1_2b VR1 VR2 VI1 VI2 AT=PQR R=0.05 B=0.1 X=0.05
 YPGBR pg1_2c VR1 VR2 VI1 VI2 AT=PQR R=0.05 B=0.1 X=0.05
 YPowerGridBranch pg1_2d Th1 Th2 VM1 VM2 AT=PQP R=0.05 B=0.1 X=0.05
 YPGBR pg1_2e Th1 Th2 VM1 VM2 AT=PQP R=0.05 B=0.1 X=0.05

Parameters and Options

type

The device type has a verbose (PowerBranchBranch) and a shortened (PGBR) form. Their usage may be mixed within a netlist.

name

Name of the device instance. This must be present, and unique amongst the PowerGridBranch devices in the netlist.

input node

There are two input nodes, <input node1> and <input node2>, whose definitions depend on the AnalysisType (AT) specified. Both nodes must be specified. This device can be viewed as a generalized 4-port resistor, using the Equivalent Real Form (ERF) described below in the equation subsections. For IV and PQR formats, <input node1> is the real part (VR) of the voltage at terminal 1 while <input node2> is the imaginary part (VI) of the voltage at terminal 1. For PQP format, <input node1> is the angle (Θ)

or Θ) of the voltage at terminal 1 while `<input node2>` is the magnitude (V_M or $|V|$) of the voltage at terminal 1. Finally, by analogy to other Xyce devices, node 1 can be considered as the positive terminal for this device, while node 2 is the negative terminal.

output node

There are two output nodes, `<output node1>` and `<output node2>`, whose definitions depend on the AnalysisType (AT) specified. Both nodes must be specified. This device can be viewed as a generalized 4-port resistor, using the ERF described below in the equation subsections. For IV and PQR formats, `<output node1>` is the real part (V_R) of the voltage at terminal 2 while `<output node2>` is the imaginary part (V_I) of the voltage at terminal 2. For PQP format, `<output node1>` is the angle (Θ or Θ) of the voltage at terminal 2 while `<output node2>` is the magnitude (V_M or $|V|$) of the voltage at terminal 2. Finally, by analogy to other Xyce devices, node 2 can be considered as the negative terminal for this device, while node 1 is the positive terminal.

- AT** This device supports all three analysis types (AT), namely IV, PQR and PQP. The equations for these analysis types are described below. All power grid devices, of all types, in a Xyce netlist must use the same analysis type. This constraint is not checked during netlist parsing. Violation of this constraint may cause unpredictable results.
- B** Branch susceptance, given in per unit. As discussed in the Equation section below, the susceptance value given on the branch description lines in IEEE Common Data Format (CDF) files is split equally between terminals 1 and 2.
- R** Branch resistance, given in per unit.
- X** Branch reactance, given in per unit.

PowerGridBranch Device Parameters

Table 2-164. PowerGridBranch Device Instance Parameters

Parameter	Description	Units	Default
AT	Analysis Type	–	'PQP'
B	Branch Shunt Susceptance	per unit	0
R	Branch Resistance	per unit	0
X	Branch Reactance	per unit	0

PowerGridBusShunt

Instance Form Y<type> <name> <input node1> <output node1>
 + <input node2> <output node2> [device parameters]

Examples

```
YPowerGridBusShunt pg1_2 VR1 VR2 VI1 VI2 AT=IV R=0.05 B=0.1 X=0.05
YPGBS pg1_2a VR1 VR2 VI1 VI2 AT=IV R=0.05 B=0.1 X=0.05
YPowerGridBusShunt pg1_2b VR1 VR2 VI1 VI2 AT=PQR R=0.05 B=0.1 X=0.05
YPGBS pg1_2c VR1 VR2 VI1 VI2 AT=PQR R=0.05 B=0.1 X=0.05
YPowerGridBusShunt pg1_2d Th1 Th2 VM1 VM2 AT=PQP R=0.05 B=0.1 X=0.05
YPGBS pg1_2e Th1 Th2 VM1 VM2 AT=PQP R=0.05 B=0.1 X=0.0
```

Parameters and Options**type**

The device type has a verbose (`PowerGridBusShunt`) and a shortened (`YPGBS`) form. Their usage may be mixed within a netlist.

name

Name of the device instance. This must be present, and unique amongst the `PowerGridBusShunt` devices in the netlist.

input node

There are two input nodes, `<input node1>` and `<input node2>`, whose definitions depend on the AnalysisType (AT) specified. Both nodes must be specified. This device can be viewed as a generalized 4-port resistor, using the Equivalent Real Form (ERF) described below in the equation subsections. For IV and PQR formats, `<input node1>` is the real part (VR) of the voltage at terminal 1 while `<input node2>` is the imaginary part (VI) of the voltage at terminal 1. For PQP format, `<input node1>` is the angle (Θ or Th) of the voltage at terminal 1 while `<input node2>` is the magnitude (VM or |V|) of the voltage at terminal 1. Finally, by analogy to other Xyce devices, node 1 can be considered as the positive terminal for this device, while node 2 is the negative terminal.

output node

There are two output nodes, `<output node1>` and `<output node2>`, whose definitions depend on the AnalysisType (AT) specified. Both nodes must be specified. This device can be viewed as a generalized 4-port resistor, using the ERF described below in the equation subsections. For IV and PQR formats, `<output node1>` is the real part (VR) of the voltage at terminal 2 while `<output node2>` is the imaginary part (VI) of the voltage at terminal 2. For PQP format, `<output node1>` is the angle (Θ or Th) of the voltage at terminal 2 while `<output node2>` is the magnitude (VM or |V|) of the voltage at terminal 2. Finally, by analogy to other Xyce devices, node 2 can be considered as the negative terminal for this device, while node 1 is the positive terminal.

AT This device supports all three analysis types (AT), namely IV, PQR and PQP. The equations for these analysis types are described below. All power grid devices, of all types, in a Xyce netlist must use the same analysis type. This constraint is not checked during netlist parsing. Violation of this constraint may cause unpredictable results.

B Shunt susceptance, given in per unit.

G Shunt conductance, given in per unit.

Bus Shunt Device Parameters

Table 2-165. PowerGridBusShunt Device Instance Parameters

Parameter	Description	Units	Default
AT	Analysis Type	–	'PQP'
B	Shunt Susceptance	per unit	0
G	Shunt Conductance	per unit	0

PowerGridTransformer

Instance Form Y<type> <name> <input node1> <output node1>
+ <input node2> <output node2> [control node] [device parameters]

Examples

```
YPowerGridTransformer pg1_2 VR1 VR2 VI1 VI2 AT=IV R=0.05 X=0.05
+ TR=0.9 PS=0.1
YPGTR pg1_2a VR1 VR2 VI1 VI2 AT=IV R=0.05 X=0.05 TR=0.9 PS={18*PI/180}
YPowerGridTransformer pg1_2b VR1 VR2 VI1 VI2 AT=PQR R=0.05 X=0.05
+ TR=0.9 PS=0.1
YPGTR pg1_2c VR1 VR2 VI1 VI2 AT=PQR R=0.05 B=0.1 X=0.05 TR=0.9 PS=0.1
YPowerGridTransformer pg1_2d Th1 Th2 VM1 VM2 AT=PQP
+ R=0.05 X=0.05 PS={18*PI/180}
YPGTR pg1_2e Th1 Th2 VM1 VM2 AT=PQP R=0.05 X=0.0 TR=0.9 PS=0.1
YPGTR pg1_2f Th1 Th2 VM1 VM2 N AT=PQP R=0.05 X=0.0 TT=VT PS=0.1
YPGTR pg1_2g Th1 Th2 VM1 VM2 Phi AT=PQP R=0.05 X=0.0 TT=PS TR=0.9
```

Parameters and Options

type

The device type has a verbose (PowerGridTransformer) and a shortened (PGTR) form. Their usage may be mixed within a netlist.

name

Name of the device instance. This must be present, and unique amongst the PowerGridTransformer devices in the netlist.

input node

There are two input nodes, <input node1> and <input node2>, whose definitions depend on the AnalysisType (AT) specified. Both nodes must be specified. This device can be viewed as a generalized 4-port resistor, using the Equivalent Real Form (ERF) described below in the equation subsections. For IV and PQR formats, <input node1> is the real part (VR) of the voltage at terminal 1 while <input node2> is the imaginary part (VI) of the voltage at terminal 1. For PQP format, <input node1> is the angle (Θ or Th) of the voltage at terminal 1 while <input node2> is the magnitude

(V_M or $|V|$) of the voltage at terminal 1. Finally, by analogy to other Xyce devices, node 1 can be considered as the positive terminal for this device, while node 2 is the negative terminal.

output node

There are two output nodes, `<output node1>` and `<output node2>`, whose definitions depend on the AnalysisType (AT) specified. Both nodes must be specified. This device can be viewed as a generalized 4-port resistor, using the ERF described below in the equation subsections. For IV and PQR formats, `<output node1>` is the real part (VR) of the voltage at terminal 2 while `<output node2>` is the imaginary part (VI) of the voltage at terminal 2. For PQP format, `<output node1>` is the angle (Θ or Θ_h) of the voltage at terminal 2 while `<output node2>` is the magnitude (V_M or $|V|$) of the voltage at terminal 2. Finally, by analogy to other Xyce devices, node 2 can be considered as the negative terminal for this device, while node 1 is the positive terminal.

control input

This is an optional node. However, it must be specified on the instance line if the transformer type (TT) is set to either 2 or 3. It does not exist, and must not be specified on the instance line, for the default of TT=1. The use of the `control input` node is covered under the definition of the TT instance parameter.

- AT** This device supports all three analysis types (AT), namely IV, PQR and PQP. The equations for these analysis types are described below. All power grid devices, of all types, in a Xyce netlist must use the same analysis type. This constraint is not checked during netlist parsing. Violation of this constraint may cause unpredictable results.
- PS** Phase shift given in radians. As illustrated above, $PS = \{18 * \pi / 180\}$ is a convenient syntax for converting between decimal degrees and radians on a Xyce instance line. This instance parameter is ignored if TT=3, since the phase shift is set by the optional `control input` node in that case.
- R** Resistance, given in per unit.
- TR** Turns ratio, given in per unit. This instance parameter is ignored if TT=2, since this value is set by the optional `control input` node in that case..
- X** Reactance, given in per unit.
- TT** This is the “Transformer Type”. It allows the user to implement tap-changing or phase-shifting transformers, by attaching an appropriate control-circuit to the `control input` node. The allowed values for TT are FT, VT or PS, with default value of FT. Any other values will cause a netlist parsing error. A transformer type of FT has a fixed turns-ratio, and is a four-terminal device with two input nodes (`<input node1>` and `<input node2>`) and two output nodes (`<output node1>` and `<output node2>`). Let the effective complex turns ratio be $r = m + jp = n * (\cos(\phi) + j * \sin(\phi))$. The transformer type of VT exposes the n variable as the `control input` node, and hence can operate with a variable turns-ratio. The transformer type of PS

exposes the ϕ variable as the `control input` node, and hence can act as a phase shifter. The instantaneous value of n (or ϕ) can be set to the voltage applied to the `control input` node. There will be no current draw into (or out of) the `control input` node. This device model does not yet support simultaneously varying both n and ϕ .

Transformer Device Parameters

Table 2-166. PowerGridTransformer Device Instance Parameters

Parameter	Description	Units	Default
AT	Analysis Type	–	'PQP'
PS	Phase Shift	rad	0
R	Resistance	per unit	0
TR	Transformer Turns Ratio	per unit	1
TT	Transformer Type	–	'FT'
X	Reactance	per unit	0

PowerGridGenBus

Instance Form Y<type> <name> <input node1> <output node1>
 + <input node2> <output node2> [device parameters]

Examples YPowerGridGenBus GenBus1 Th1 0 VM1 0 AT=PQP VM=1.045 P=0.4
 YPGGB GenBus2 Th2 GND VM2 GND AT=PQP VM=1.045 P=0.4

Parameters and Options

type

The device type has a verbose (`PowerGridGenBus`) and a shortened (`PGGB`) form. Their usage may be mixed within a netlist.

name

Name of the device instance. This must be present, and unique amongst the `PowerGridGenBus` devices in the netlist.

input node

There are two input nodes, `<input node1>` and `<input node2>`, whose definitions depend on the AnalysisType (AT) specified. Both nodes must be specified. This device can be viewed as a generalized 4-port resistor, using the Equivalent Real Form (ERF) described below in the equation subsections. For IV and PQR formats, `<input node1>` is the real part (VR) of the voltage at terminal 1 while `<input node2>` is the imaginary part (VI) of the voltage at terminal 1. For PQP format, `<input node1>` is the angle (Θ or Th) of the voltage at terminal 1 while `<input node2>` is the magnitude (VM or |V|) of the voltage at terminal 1. Finally, by analogy to other Xyce

devices, node 1 can be considered as the positive terminal for this device, while node 2 is the negative terminal.

output node

There are two output nodes, <output node1> and <output node2>, whose definitions depend on the AnalysisType (AT) specified. Both nodes must be specified. This device can be viewed as a generalized 4-port resistor, using the ERF described below in the equation subsections. For IV and PQR formats, <output node1> is the real part (VR) of the voltage at terminal 2 while <output node2> is the imaginary part (VI) of the voltage at terminal 2. For PQP format, <output node1> is the angle (Θ or Θ_h) of the voltage at terminal 2 while <output node2> is the magnitude (VM or $|V|$) of the voltage at terminal 2. Finally, by analogy to other Xyce devices, node 2 can be considered as the negative terminal for this device, while node 1 is the positive terminal.

AT This device currently only supports the PQP analysis type (AT). The equations for the PQP analysis type are described below. All power grid devices, of all types, in a Xyce netlist must use the same analysis type. This constraint is not checked during netlist parsing. Violation of this constraint may cause unpredictable results.

P Generator Output Power, given in per unit. As noted below, positive real power (P) and positive reactive power (Q) flow out of the positive (<input node1> and <input node2>) terminals into the power grid. This is opposite from the normal convention for voltage and current sources in Xyce and SPICE.

QLED

This is the Q-Limit Enforcement Delay. It is only used if either QMAX or QMIN is specified. The Q-Limits are not enforced for the first QLED Newton iterations of the DC Operating Point (DCOP) calculation. This may be useful if a given generator bus has, for example, a very small value of QMIN [36]. If QMAX or QMIN is specified and QLED is omitted then the default QLED value of 0 is used.

QMAX

The upper limit on the reactive power (Q) flow into the power grid, given in per unit. If this parameter is omitted on the instance line then no upper limit on the reactive power flow is enforced. It is recommended that either both QMAX and QMIN be specified or that both be omitted.

QMIN

The lower limit on the reactive power (Q) flow into the power grid, given in per unit. If this parameter is omitted on the instance line then no lower limit on the reactive power flow is enforced. It is recommended that either both QMAX and QMIN be specified or that both be omitted.

VM Fixed voltage magnitude, given in per unit.

Generator Bus Device Parameters

Table 2-167. PowerGridGenBus Device Instance Parameters

Parameter	Description	Units	Default
AT	Analysis Type	–	'PQP'
P	Generator Output Power	per unit	1
QLED	Q-Limit Enforcement Delay	–	0
QMAX	Reactive Power Max Limit	per unit	1
QMIN	Reactive Power Min Limit	per unit	0
VM	Voltage Magnitude	per unit	1

Branch Current and Power Accessors This version of the Power Grid devices does not support the branch current accessor, I(), or the power accessors, P() or W().

Compatibility with .STEP .STEP should work with all of the instance parameters for the power grid devices. The two exceptions are the Analysis Type (AT) for all of the power grid devices and the Transformer Type (TT) for the Transformer device. Those two parameters must be constant for all steps.

Model Limitations and Caveats The following features are not supported by this release of the Power Grid device models.

- The Generator Bus device model only supports the PQ Polar format. So, reactive power (QMAX and QMIN) limits in the Generator Bus device model are also only supported for that format.
- Magnetizing susceptance for transformers.
- Certain instance parameters, or combinations of instance parameters, will cause errors during netlist parsing. In particular, either B, R or X must be non-zero for the Branch device. Either B or G must be non-zero for the Bus Shunt device. Either R or X must be non-zero for the Transformer device. TR must not be zero for the Transformer device. VM must be positive for the Generator Bus device.

Equivalent Real Form An Equivalent Real Form (ERF) must be used to make the complex-valued voltage-current and power-flow equations compatible with the real-valued solvers used by Xyce. The equations given below use a K1 ERF [35], which solves the complex-valued system of equations $I = YV$ as follows. Let $Y = (g + jb)$, $V = (V_R + jV_I)$ and $I = (I_R + jI_I)$. Then the equivalent set of real-valued equations is:

$$\begin{bmatrix} I_R \\ I_I \end{bmatrix} = \begin{bmatrix} g & -b \\ g & b \end{bmatrix} \begin{bmatrix} V_R \\ V_I \end{bmatrix} \quad (2.25)$$

Y Matrices for Power Grid Branch and Bus Shunt The Y-Matrix for the PowerGridBranch device can be expressed as follows where $A = (R + jX)^{-1}$, R is the branch resistance, X is the branch reactance and B is the branch shunt susceptance given on the device's instance line:

$$\begin{bmatrix} Y_{11} & Y_{12} \\ Y_{21} & Y_{22} \end{bmatrix} = \begin{bmatrix} g_{11} + jb_{11} & g_{12} + jb_{12} \\ g_{21} + jb_{21} & g_{22} + jb_{22} \end{bmatrix} = \begin{bmatrix} A & -A + 0.5j * B \\ -A + 0.5j * B & A \end{bmatrix} \quad (2.26)$$

The Y-Matrix for the PowerGridBusShunt device can be expressed as follows where G is the bus shunt

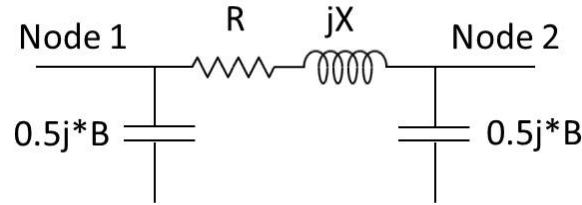

Figure 2-5. Lumped Π Model for PowerGridBranch.

conductance and B is the bus shunt susceptance given on the device's instance line:

$$\begin{bmatrix} Y_{11} & Y_{12} \\ Y_{21} & Y_{22} \end{bmatrix} = \begin{bmatrix} g_{11} + jb_{11} & g_{12} + jb_{12} \\ g_{21} + jb_{21} & g_{22} + jb_{22} \end{bmatrix} = \begin{bmatrix} G + jB & -G - jB \\ -G - jB & G + jB \end{bmatrix} \quad (2.27)$$

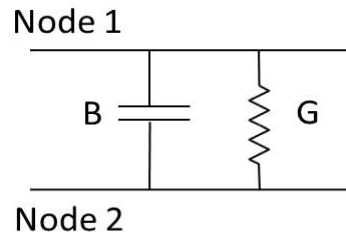

Figure 2-6. Equivalent Circuit for PowerGridBusShunt.

Equations Common to Power Grid Branch and Bus Shunt The PowerGridBranch and PowerGridBusShunt devices use the same basic equations to model voltage and current flow or voltage and power flow. The differences are in the Y-Matrices described above. There are three options for the equations used, namely I=YV, PQ Polar and PQ Rectangular.

For the I=YV format, the device equations for the PowerGridBranch and PowerGridBusShunt devices are as follows, where the g_{ij} and b_{ij} terms are given above. Also, V_{R1} and V_{I1} are the real and imaginary parts of the voltage at terminal 1. I_{R1} and I_{I1} are the real and imaginary parts of the current at terminal 1.

$$\begin{bmatrix} I_{R1} \\ I_{R2} \\ I_{I1} \\ I_{I2} \end{bmatrix} = \begin{bmatrix} g_{11} & g_{12} & -b_{11} & -b_{12} \\ g_{21} & g_{22} & -b_{21} & -b_{22} \\ b_{11} & b_{12} & g_{11} & g_{12} \\ b_{21} & b_{22} & g_{21} & g_{22} \end{bmatrix} \begin{bmatrix} V_{R1} \\ V_{R2} \\ V_{I1} \\ V_{I2} \end{bmatrix} \quad (2.28)$$

For the PQ Rectangular format, the device equations are nonlinear [36].

$$P_1 = g_{11}(V_{R1}^2 + V_{I1}^2) + V_{R1}(g_{12} * V_{R2} - b_{12} * V_{I2}) + V_{I1}(b_{12} * V_{R2} + g_{12} * V_{I2}) \quad (2.29)$$

$$P_2 = g_{22}(V_{R2}^2 + V_{I2}^2) + V_{R2}(g_{21} * V_{R1} - b_{21} * V_{I1}) + V_{I2}(b_{21} * V_{R1} + g_{21} * V_{I1}) \quad (2.30)$$

$$Q_1 = -b_{11}(V_{R1}^2 + V_{I1}^2) + V_{I1}(g_{12} * V_{R2} - b_{12} * V_{I2}) + V_{R1}(b_{12} * V_{R2} + g_{12} * V_{I2}) \quad (2.31)$$

$$Q_2 = -b_{22}(V_{R2}^2 + V_{I2}^2) + V_{I2}(g_{21} * V_{R1} - b_{21} * V_{I1}) + V_{R2}(b_{21} * V_{R1} + g_{21} * V_{I1}) \quad (2.32)$$

For the PQ Polar format, the device equations are also nonlinear [36]. Define $|V_1|$ as the voltage magnitude at terminal 1 and Θ_1 as the voltage angle at terminal 1.

$$P_1 = g_{11} * |V_1|^2 + |V_1| * |V_2| * (g_{12} * \cos(\Theta_1 - \Theta_2) + b_{12} * \sin(\Theta_1 - \Theta_2)) \quad (2.33)$$

$$P_2 = g_{22} * |V_2|^2 + |V_2| * |V_1| * (g_{21} * \cos(\Theta_2 - \Theta_1) + b_{21} * \sin(\Theta_2 - \Theta_1)) \quad (2.34)$$

$$Q_1 = -b_{11} * |V_1|^2 + |V_1| * |V_2| * (g_{12} * \sin(\Theta_1 - \Theta_2) - b_{12} * \cos(\Theta_1 - \Theta_2)) \quad (2.35)$$

$$Q_2 = -b_{22} * |V_2|^2 + |V_2| * |V_1| * (g_{21} * \sin(\Theta_2 - \Theta_1) - b_{21} * \cos(\Theta_2 - \Theta_1)) \quad (2.36)$$

Equations for Power Grid Transformer The equations for the PowerGridTransformer device are similar to those used by the PowerGridBranch and PowerGridBusShunt devices. The circuit diagram for the PowerGridTransformer is shown below.

For I=YV and PQ Rectangular formats, the equations are the same as for the PowerGridBranch and PowerBusBusShunt devices. However, the following Y-Matrix is used where where $A = (R + jX)^{-1}$, R is the resistance, X is the reactance, n is the turns ratio (which is the TR instance parameter) and ϕ is the phase shift in radians (which is the PS instance parameter).

For the I=YV and PQ Rectangular formats, the Y matrix is not symmetric and is given by the following [37]. Let the effective complex turns ratio be $r = m + jp = n * (\cos(\phi) + j * \sin(\phi))$:

$$\begin{bmatrix} Y_{11} & Y_{12} \\ Y_{21} & Y_{22} \end{bmatrix} = \begin{bmatrix} g_{11} + jb_{11} & g_{12} + jb_{12} \\ g_{21} + jb_{21} & g_{22} + jb_{22} \end{bmatrix} = \begin{bmatrix} A * (m^2 + p^2)^{-1} & -A * (m - jp)^{-1} \\ -A * (m + jp)^{-1} & A \end{bmatrix} \quad (2.37)$$

The voltage-current and power flow equations for the I=YV and PQ Rectangular formats are then the same as for the PowerGridBranch and PowerGridBusShunt devices, with the modified Y-matrix parameters given above.

For the PQ Polar format, the Y matrix is not symmetric and is given by [36]:

$$\begin{bmatrix} Y_{11} & Y_{12} \\ Y_{21} & Y_{22} \end{bmatrix} = \begin{bmatrix} g_{11} + jb_{11} & g_{12} + jb_{12} \\ g_{21} + jb_{21} & g_{22} + jb_{22} \end{bmatrix} = \begin{bmatrix} A * n^{-2} & -A * n^{-1} \\ -A * n^{-1} & A \end{bmatrix} \quad (2.38)$$

The power flow equation for PQ Polar format are then:

$$P_1 = g_{11} * |V_1|^2 + |V_1| * |V_2| * (g_{12} * \cos(\Theta_1 - \Theta_2 - \phi) + b_{12} * \sin(\Theta_1 - \Theta_2 - \phi)) \quad (2.39)$$

$$P_2 = g_{22} * |V_2|^2 + |V_2| * |V_1| * (g_{21} * \cos(\Theta_2 - \Theta_1 + \phi) + b_{21} * \sin(\Theta_2 - \Theta_1 + \phi)) \quad (2.40)$$

$$Q_1 = -b_{11} * |V_1|^2 + |V_1| * |V_2| * (g_{12} * \sin(\Theta_1 - \Theta_2 - \phi) - b_{12} * \cos(\Theta_1 - \Theta_2 - \phi)) \quad (2.41)$$

$$Q_2 = -b_{22} * |V_2|^2 + |V_2| * |V_1| * (g_{21} * \sin(\Theta_2 - \Theta_1 + \phi) - b_{21} * \cos(\Theta_2 - \Theta_1 + \phi)) \quad (2.42)$$

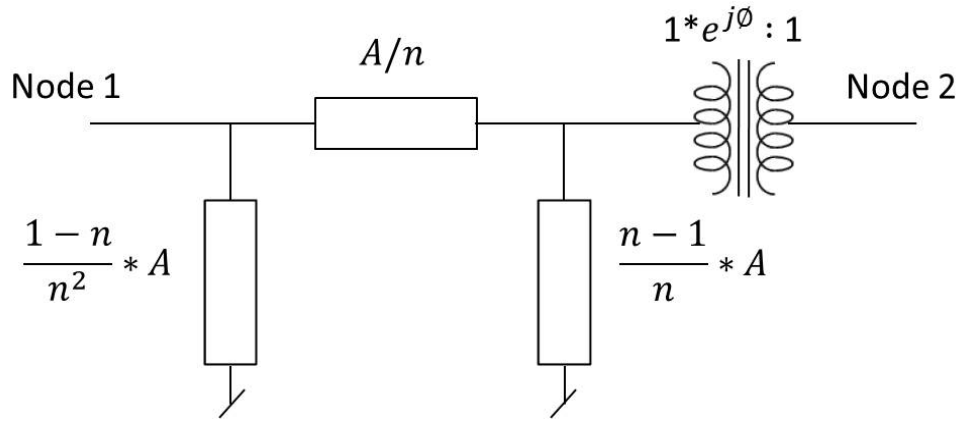

Figure 2-7. Equivalent Circuit for PowerGridTransformer.

Equations for Power Grid Gen Bus The PowerGridGenBus is an active device that functions as an ideal generator with a fixed power output (P) and voltage magnitude (VM). Reactive power (QMAX and QMIN) limits are also supported. The device equations for the PQ Polar format are as follows [36]. The other solution formulations are not supported in this release. If reactive power limits are not being enforced then:

$$P_1 = P \quad (2.43)$$

$$|V_1| = VM \quad (2.44)$$

If reactive power limits are being enforced then P_1 is still held constant but the behavior of the V_1 terminal changes between a constant-voltage and a constant-current source. In particular, $|V_1| = VM$ only if $QMIN < Q_1 < QMAX$. Otherwise, $|V_1|$ is unconstrained and the appropriate QMIN or QMAX value is enforced at the V_1 terminal instead.

The convention for Power Grids is that positive power is injected into the grid. So, positive real (P) and reactive power (Q) flow out of the positive terminals (inputNode 1 and inputNode 2). This is reversed from the normal convention for current direction for voltage and current sources in either Xyce or SPICE.

2.3.32. Memristor Device



Instance Form `y memristor <name> <(+) node> <(-) node> <model>`

Model Form `.MODEL <model name> MEMRISTOR level=2 [model parameters]`

Examples

```
y memristor mr1 n1 n2 mrm2

.model mrm2 memristor level=2 ron=50 roff=1000
+ koff=1.46e-18 kon=-4.68e-22
+ alphaoff=10 alphaon=10 wc=1.0e-12
+ ioff=115e-6 ion=-8.9e-6 xscaling=1.0e9 wt=4

y memristor mr2 n1 n2 mrm3 xo=0.11

.MODEL mrm3 memristor level=3 a1=0.17 a2=0.17 b=0.05 vp=0.16 vn=0.15
+ ap=4000 an=4000 xp=0.3 xn=0.5 alphap=1 alphan=5 eta=1

y memristor mr3 n1 n2 mrm4

.model mrm4 memristor level=4
+ fxpdata=fxp_table.csv
+ fxmdata=fxm_table.csv
+ I1=85.37e-6 I2=90.16e-6 V1=0.265 V2=0.265 G0=130.72e-6
+ VP=0.7 VN=1.0 d1=9.87 d2=-4.82
+ C1=1000 C2=1000
```

Parameters and

Options

(+) node

(-) node

Polarity definition for a positive voltage across the memristor. The first node is defined as positive. Therefore, the voltage across the component is the first node voltage minus the second node voltage.

Comments

The `level=2` memristor device is an implementation of the TEAM formulation described in [38] and [39]. The `level=3` memristor device is an implementation of the Yakopcic formulation described in [40]. The `level=4` memristor device is an implementation of the Piecewise Empirical Model described in [41].

Positive current flows from the (+) node through the device to the (-) node. The power through the device is calculated with $I \cdot \Delta V$ where the voltage drop is calculated as $(V_+ - V_-)$ and positive current flows from V_+ to V_- .

Device Equations for TEAM Formulation The current voltage relationship for the TEAM formulation can be linear or nonlinear and this is selectable with the instance parameter IVRELATION. The default is the linear relationship which is:

$$v(t) = \left[R_{ON} + \frac{R_{OFF} - R_{ON}}{x_{OFF} - x_{ON}} (x - x_{ON}) \right] i(t) \quad (2.45)$$

The non-linear relationship is:

$$v(t) = R_{ON} e^{\lambda(x-x_{ON})/(x_{OFF}-x_{ON})} i(t) \quad (2.46)$$

where λ is defined as:

$$\frac{R_{OFF}}{R_{ON}} = e^{\lambda} \quad (2.47)$$

In the above equations x represents a doped layer whose growth determines the overall resistance of the device. The equation governing the value of x is:

$$\frac{dx}{dt} = \begin{cases} k_{OFF} \left(\frac{i}{i_{OFF}} - 1 \right)^{\alpha_{OFF}} f_{OFF}(x) & 0 < i_{OFF} < i \\ 0 & i_{ON} < i < i_{OFF} \\ k_{ON} \left(\frac{i}{i_{on}} - 1 \right)^{\alpha_{on}} f_{ON}(x) & i < i_{ON} < 0 \end{cases} \quad (2.48)$$

The functions $f_{ON}(x)$ and $f_{OFF}(x)$ are window functions designed to keep x within the defined limits of x_{ON} and x_{OFF} . Four different types of window functions are available and this is selectable with the model parameter WT. Note that the TEAM memristor device is formulated to work best with the TEAM, Kvatinsky, window function WT=4 . Other window functions should be used with caution.

Device Equations for Yakopcic Formulation The current voltage relationship for the Yakopcic memristor device is: [40]

$$I(t) = \begin{cases} a_1 x(t) \sinh(bV(t)) & V(t) \geq 0 \\ a_2 x(t) \sinh(bV(t)) & V(t) < 0 \end{cases} \quad (2.49)$$

$$g(V(t)) = \begin{cases} A_p (\exp^{V(t)} - \exp^{V_p}) & V(t) > V_p \\ -A_n (\exp^{-V(t)} - \exp^{V_n}) & V(t) < -V_n \\ 0 & -V_n \leq V(t) \leq V_p \end{cases} \quad (2.50)$$

The internal state variable, x , is governed by the equation:

$$\frac{dx}{dt} = ng(V(t))f(x(t)) \quad (2.51)$$

where $f(x)$ is defined by:

$$f(x) = \begin{cases} \exp^{-\alpha_p(x-x_p)} w_p(x, x_p) & x \geq x_p \\ 1 & x \leq x_p \end{cases} \quad (2.52)$$

$$f(x) = \begin{cases} \exp^{\alpha_n(x+x_n-1)} w_n(x, x_n) & x \leq 1 - x_n \\ 1 & x > 1 - x_n \end{cases} \quad (2.53)$$

$$w_p(x, x_p) = \frac{x_p - x}{1 - x_p} + 1 \quad (2.54)$$

$$w_n(x, x_n) = \frac{x}{1 - x_n} \quad (2.55)$$

Note, the quantities, $x_p, x_n, \alpha_p, \alpha_n, A_p, A_n, a_1, a_2$ and b are model parameters that can be specified in the device's model block.

Device Equations for the PEM Formulation The PEM memristor device is similar to the TEAM and Yakopcic formulations in that an internal state variable, x , is used to capture the device's response to its history.

The I-V relationship is

$$I = x h(V) \quad (2.56)$$

and $h(V)$ is defined by:

$$h(V) = I_1 * \exp(V/V_1) - I_2 * \exp(-V/V_2) + G_0V - (I_1 - I_2) \quad (2.57)$$

where I_1, I_2, V_1, V_2 and G_0 are model parameters.

The internal variable, x , is defined by:

$$\frac{dx}{dt} = G(V)f(x) \quad (2.58)$$

with

$$G(V) = \begin{cases} C_1 \left(\exp^{d_1[V(t)-V_p]} - 1 \right) & V > V_p \\ C_2 \left(\exp^{d_2[V(t)-V_n]} - 1 \right) & V < -V_n \\ 0 & -V_n \leq V(t) \leq V_p \end{cases} \quad (2.59)$$

Finally, the function $f(x)$ is defined by a user supplied set set data which is used with linear interpolation to find the current value of $f(x)$. Separate data sets are used for forward bias and reverse bias.

$$f(x) = \begin{cases} F^+ \text{dataset} & V > 0 \\ F^- \text{dataset} & V < 0 \end{cases} \quad (2.60)$$

Device Parameters for TEAM Formulation

Table 2-168. MemristorTEAM Device Instance Parameters

Parameter	Description	Units	Default
IVRELATION	IV relationship to use, 0 is linear, 1 is nonlinear	–	0

Model Parameters for TEAM Formulation

Table 2-169. MemristorTEAM Device Model Parameters

Parameter	Description	Units	Default
ALPHAOFF	Modeling Coefficient	–	3
ALPHAON	Modeling Coefficient	–	3
AOFF	Window Function Parameter (window 4)	m	3e-09
AON	Window Function Parameter (window 4)	m	0
D	Window Function Parameter (windows 1, 2 and 3)	–	0.000115
IOFF	Current scale in off state	Ω	0.000115
ION	Current scale in On state	A	8.9e-06
J	Window Function Parameter (window 3)	–	0.000115
KOFF	Modeling Coefficient	m/s	8e-13
KON	Modeling Coefficient	m/s	-8e-13
P	Window Function Parameter (windows 1, 2 and 3)	–	0.000115
ROFF	Resistance in off state	Ω	1000
RON	Resistance in on state	Ω	50
WC	Window Function Parameter (window 4)	m	1.07e-12
WT	Type of windowing function: 0-None, 1-Jogelkar, 2-Biolek, 3-Prodromakis, 4-Kvatinsky	–	0
XOFF	Modeling Coefficient	m	3e-09
XON	Modeling Coefficient	m	0
XSCALING	Scaling for x variable. For example 1e9 if x will be in units of nanometers.	–	1

Device Parameters for Yakopcic Formulation

Table 2-170. MemristorYakopcic Device Instance Parameters

Parameter	Description	Units	Default
XO	Initial value for internal variable x	–	0

Model Parameters for Yakopcic Formulation

Table 2-171. MemristorYakopcic Device Model Parameters

Parameter	Description	Units	Default
A1	Dielectric layer thickness parameter [dimensionless]	–	1
A2	Dielectric layer thickness parameter [dimensionless]	–	1
ALPHAN	State variable motion.	–	1

Table 2-171. MemristorYakopic Device Model Parameters

Parameter	Description	Units	Default
ALPHAP	State variable motion.	–	1
AN	Negative Voltage Threshold Magnitude Parameter	–	1
AP	Positive Voltage Threshold Magnitude Parameter	–	1
B	Curvature in I-V relation. Relates to how much conduction in the device is Ohmic and versus tunnel barrier.	–	1
ETA	State variable motion relative to voltage.	–	1
RESEDELTA	RTN model in resistance: Base change in resistance for RTN	Ω	0
RESEDELTA GRAD	RTN model in resistance: Base change in resistance for RTN scaled by R	–	0
RESEPTD	RTN model in resistance: Minimum allowed update time	s	1e-10
RESLAMBDA	RTN model: lambda	–	0
RESNOISE	RTN model in resistance (on/off)	–	false
RESSEED	RTN model in resistance: seed	–	0
RESTD	RTN model in resistance: Update time	s	0
VN	Negative Voltage Threshold	V	-0.01
VP	Positive Voltage Threshold	V	0.01
XDELTA	RTN model in growth: Base change in growth rate for RTN	Ω	0
XDELTA GRAD	RTN model in growth: Base change in growth for RTN scaled by X	–	0
XEPTD	RTN model in growth: Minimum allowed update time	s	1e-10
XLAMBDA	RTN growth model: lambda	–	0
XN	State variable motion.	–	1
XNOISE	RTN model in growth (on/off)	–	false
XP	State variable motion.	–	1
XSCALING	Scaling for x variable. For example 1e9 if x will be in units of nanometers.	–	1
XSEED	RTN model in growth: seed	–	0
XTD	RTN model in growth: Update time	s	0

Device Parameters for PEM Formulation

Table 2-172. MemristorPEM Device Instance Parameters

Parameter	Description	Units	Default
X0	Initial value for internal variable x	–	0

Model Parameters for PEM Formulation

Table 2-173. MemristorPEM Device Model Parameters

Parameter	Description	Units	Default
C1	State variable proportionality parameter for forward bias	–	1
C2	State variable proportionality parameter for negative bias	–	1
D1	Positive Voltage Threshold Magnitude Parameter	–	1
D2	Negative Voltage Threshold Magnitude Parameter	–	1
FXMDATA	File from which to read x,f-(x) data	–	'filem.dat'
FXPDATA	File from which to read x,f+(x) data	–	'filep.dat'
G0	Conductance factor.	–	1
I1	Current Scale factor.	A	1
I2	Current Scale factor.	A	1
V1	Voltage Scale factor.	V	1
V2	Voltage Scale factor.	V	1
VN	Negative Voltage Threshold	V	-0.01
VP	Positive Voltage Threshold	V	0.01

2.3.33. Subcircuit

A subcircuit can be introduced into the circuit netlist using the specified nodes to substitute for the argument nodes in the definition. It provides a building block of circuitry to be defined a single time and subsequently used multiple times in the overall circuit netlists. See Section 2.1.37 for more information about subcircuits.

Instance Form X<name> [node]* <subcircuit name> [PARAMS: [<name> = <value>]*]

Examples X12 100 101 200 201 DIFFAMP
 XBUFF 13 15 UNITAMP
 XFOLLOW IN OUT VCC VEE OUT OPAMP
 XFELT 1 2 FILTER PARAMS: CENTER=200kHz
 XNANDI 25 28 7 MYPWR MYGND PARAMS: IO_LEVEL=2

Parameters and Options

subcircuit name

The name of the subcircuit's definition.

PARAMS:

Passed into subcircuits as arguments and into expressions inside the subcircuit.

Comments

There must be an equal number of nodes in the subcircuit call and in its definition.

Subcircuit references may be nested to any level. However, the nesting cannot be circular. For example, if subcircuit A's definition includes a call to subcircuit B, then subcircuit B's definition cannot include a call to subcircuit A.

2.4. TCAD Devices

Semiconductor device simulation, which is based on a coupled set of partial differential equations (PDE's) is supported in Xyce. Such devices can be invoked from the circuit netlist in a manner similar to traditional SPICE-style analog devices. One dimensional and two dimensional devices are supported, with the dimensionality determined by the device model level.

1D Device Form YPDE <name> <node> [node] [model name]
+ [device parameters]

2D Device Form YPDE <name> <node> <node> [node][node] [model name] |
+ [device parameters]

Model Form .MODEL <model name> ZOD [model parameters]

Comments All of the PDE parameters are specified on the instance level. The model statement is used only for specifying if the device is 1D or 2D, via the level parameter. Both the 1D and the 2D devices can construct evenly-spaced meshes internally, or an unstructured mesh can be read in from an external mesh file.

The electrode, doping and material parameters are specified using a special format that is described in the tables that are referenced in the instance parameter tables.

TCAD Device Parameters Most TCAD device parameters are specified on the instance level. The only TCAD device model parameter is the level, which specifies whether the model is one or two dimensions.

Table 2-174. PDE Device Model Parameters

Parameter	Description	Units	Default
LEVEL	Determines if the device is 1D or 2D 1=1D, 2=2D	–	1

Table 2-175. 1D PDE (level 1) Device Instance Parameters

Parameter	Description	Units	Default
AUGER	Flag to turn on/off Auger recombination	logical (T/F)	true
BULKMATERIAL	Bulk semiconductor material	–	'SI'
DOPINGPROFILES			See Table 2-180
FERMIDIRAC	Use Fermi-Dirac statistics.	logical (T/F)	false
FIELDDEP	If true, use field dependent mobility.	logical (T/F)	false
LAYER			See Table 2-177

Table 2-175. 1D PDE (level 1) Device Instance Parameters

Parameter	Description	Units	Default
MASKVARSTIA	If set to true, then some variables are excluded from the time integration error control calculation.	logical (T/F)	false
MAXVOLTDELTA	Maximum voltage change used by two-level Newton algorithm.	V	0.025
MESHFILE		–	'internal.msh'
MOBMODEL	Mobility model.	–	'ARORA'
NODE			See Table 2-178
NX	Number of mesh points	–	11
REGION			See Table 2-181
SRH	Flag to turn on/off Shockley-Read-Hall (SRH) recombination.	logical (T/F)	true
THERMIONICEMISSION		logical (T/F)	false
TUNNELING		–	'none'
USEOLDNI	Flag for using old(inaccurate) intrinsic carrier calculation.	logical (T/F)	false
VOLTLIM	Flag to apply voltage limiting. This is only relevant for an experimental two-level Newton solver.	logical (T/F)	false
<i>Doping Parameters</i>			
DOPING_FILE	File containing doping profile.	–	'NOFILE'
GRADED	Flag for graded junction vs. abrupt junction. – (1/true=graded, 0/false=abrupt)	logical (T/F)	false
NA	Acceptor doping level	cm ⁻³	1e+15
ND	Donor doping level	cm ⁻³	1e+15
NDOPE_FILE	File containing doping profile for N-type dopants.	–	'NOFILE'
PDOPE_FILE	File containing doping profile for P-type dopants.	–	'NOFILE'
WJ	Junction width, if graded junction enabled.	cm	0.0001
<i>Geometry Parameters</i>			
ANODE.AREA	Anode area (used for two-terminal devices)	cm ⁻²	0
AREA	Cross sectional area of the device.	cm ⁻²	1
BASE.AREA	Base area (used for three-terminal (BJT) devices)	cm ⁻²	0
BASE.LOC	Location of base contact (necessary if running with three terminals).	cm	0.0005
CATHODE.AREA	Cathode area (used for two-terminal devices)	cm ⁻²	0
COLLECTOR.AREA	Collector area (used for three-terminal (BJT) devices)	cm ⁻²	0
EMITTER.AREA	Emitter area (used for three-terminal (BJT) devices)	cm ⁻²	0
L	Device width. (Synonym with W parameter)	cm	0.001
W	Device width. (Synonym with L parameter)	cm	0.001

Table 2-175. 1D PDE (level 1) Device Instance Parameters

Parameter	Description	Units	Default
<i>Temperature Parameters</i>			
TEMP	Device temperature	°C	27
<i>Model Output Parameters</i>			
FIRSTELECTRODEOFFSET	This is an output parameter. It is only used if OFFSETOUTPUTVOLTAGE=true. (see description of that parameter)	logical (T/F)	false
GNUPLOTLEVEL	Flag for gnuplot output. 0 - no gnuplot files. 1 - gnuplot files. gnuplot is an open source plotting program that is usually installed on Linux systems. gnuplot files will have the *Gnu.dat suffix, and the prefix will be the name of the device instance.	-	1
OFFSETOUTPUTVOLTAGE	This is an output parameter that determines the “zero” of the potential at output. If OFFSETOUTPUTVOLTAGE=true (default) it will adjust the voltages at output so that the minimum voltage is zero. If true and also FIRSTELECTRODEOFFSET=true, then the voltage of the first electrode is the zero point. If OFFSETOUTPUTVOLTAGE=false, the output voltage sets the intrinsic Fermi level to zero. Depending on circumstances each of these may be more or less convenient for plotting.	logical (T/F)	true
OUTPUTINTERVAL	Time interval for tecplot output (if tecplot is enabled).	s	0
OUTPUTNLPOISSON	Flag to determine if the results of the nonlinear Poisson calculation is included in the output files. Normally, this calculation is used to initialize a drift-diffusion calculation and isn't of interest.	logical (T/F)	false
TECLOTLEVEL	Setting for Tecplot output: 0 - no Tecplot files 1 - Tecplot files, each output in a separate file. 2 - Tecplot file, each output appended to a single file. Tecplot files will have the .dat suffix, and the prefix will be the name of the device instance	-	1
<i>Scaling Parameters</i>			
C0	Density scalar; adjust to mitigate convergence problems. The model will do all of its scaling automatically, so it is generally not necessary to specify it manually.	cm ⁻³	1e+15
DENSITYSCALARFRACTION	Fraction of the maximum doping by which density will be scaled. The model will do all of its scaling automatically, so it is generally not necessary to specify it manually.	logical (T/F)	0.1
SCALEDDENSITYTOMAXDOPING	If set the density will be scaled by a fraction of the maximum doping. The model will do all of its scaling automatically, so it is generally not necessary to specify it manually.	logical (T/F)	true

Table 2-175. 1D PDE (level 1) Device Instance Parameters

Parameter	Description	Units	Default
t0	Time scalar; adjust to mitigate convergence problems. The model will do all of its scaling automatically, so it is generally not necessary to specify it manually.	s	1e-06
X0	Length scalar; adjust to mitigate convergence problems. The model will do all of its scaling automatically, so it is generally not necessary to specify it manually.	cm	1e-07
<i>Boundary Condition Parameters</i>			
ANODE.BC	Anode voltage boundary condition. Only used if device is uncoupled from circuit, and running in diode mode.	V	0.5
BASE.BC	Base voltage boundary condition. Only used if device is uncoupled from circuit, and running in BJT mode.	V	0
CATHODE.BC	Cathode voltage boundary condition. Only used if device is uncoupled from circuit, and running in diode mode.	V	0
COLLECTOR.BC	Collector voltage boundary condition. Only used if device is uncoupled from circuit, and running in BJT mode.	V	0
EMITTER.BC	Emitter voltage boundary condition. Only used if device is uncoupled from circuit, and running in BJT mode.	V	0.5

Table 2-176. 2D PDE (level 2) Device Instance Parameters

Parameter	Description	Units	Default
AUGER	Flag to turn on/off Auger recombination	logical (T/F)	true
BULKMATERIAL	Material of bulk material.	–	'SI'
DISPLCUR	If true, displacement current is computed and output	logical (T/F)	false
DOPINGPROFILES			See Table 2-180
MAXVOLTDELTA	Maximum voltage change used by two-level Newton algorithm.	V	0.025
MESHFILE	This is a required field for a 2D simulation. If the user specifies meshfile=internal.mesh, the model will create a Cartesian mesh using the parameters L,W,NX and NY. If the user specifies anything else (for example meshfile=diode.msh), the model will attempt to read in a mesh file of that name. The format is assumed to be that of the SG Framework.	–	'internal.msh'
MOBMODEL	Mobility model.	–	'ARORA'
NODE			See Table 2-179
NX	Number of mesh points, x-direction.	–	11
NY	Number of mesh points, y-direction.	–	11
REGION			See Table 2-181
SRH	Flag to turn on/off Shockley-Read-Hall (SRH) recombination.	logical (T/F)	true
TYPE	P-type or N-type - this is only relevant if using the default dopings	–	'PNP'
USEOLDNI	Flag for using old (inaccurate) intrinsic carrier calculation.	logical (T/F)	false
VOLTLIM		logical (T/F)	false
<i>Doping Parameters</i>			
GRADED	Flag for graded junction vs. abrupt junction. – (1/true=graded, 0/false=abrupt)	logical (T/F)	false
NA	Acceptor doping level	cm ⁻³	1e+15
ND	Donor doping level	cm ⁻³	1e+15
WJ	Junction width, if graded junction enabled.	cm	0.0001
<i>Geometry Parameters</i>			
AREA	Cross sectional area of the device.	cm ⁻²	1
CYL	Flag to enable cylindrical geometry	logical (T/F)	false
L	Device length	cm	0.001
W	Device width	cm	0.001

Table 2-176. 2D PDE (level 2) Device Instance Parameters

Parameter	Description	Units	Default
<i>Temperature Parameters</i>			
TEMP	Device temperature	°C	27
<i>Model Output Parameters</i>			
GNUPLOTLEVEL	Flag for gnuplot output. 0 - no gnuplot files. 1 - gnuplot files. gnuplot is an open source plotting program that is usually installed on Linux systems. gnuplot files will have the *Gnu.dat suffix, and the prefix will be the name of the device instance.	–	0
INTERPGRIDSZ		–	20
OUTPUTINTERVAL	Time interval for tecplot output (if tecplot is enabled).	s	0
OUTPUTNLPOISSON	Flag to determine if the results of the nonlinear Poisson calculation is included in the output files. Normally, this calculation is used to initialize a drift-diffusion calculation and isn't of interest.	logical (T/F)	false
TECPLOTLEVEL	Setting for Tecplot output: 0 - no Tecplot files 1 - Tecplot files, each output in a separate file. 2 - Tecplot file, each output appended to a single file. Tecplot files will have the .dat suffix, and the prefix will be the name of the device instance	–	1
TXTDATALEVEL	Flag for volume-averaged text output. 0 - no text files. 1 - text files. txtdataplot files will have the *.txt suffix, and the prefix will be the name of the device instance.	–	1
<i>Scaling Parameters</i>			
C0	Density scalar; adjust to mitigate convergence problems. The model will do all of its scaling automatically, so it is generally not necessary to specify it manually.	cm ⁻³	1e+15
t0	Time scalar; adjust to mitigate convergence problems. The model will do all of its scaling automatically, so it is generally not necessary to specify it manually.	s	1e-06
X0	Length scalar; adjust to mitigate convergence problems. The model will do all of its scaling automatically, so it is generally not necessary to specify it manually.	cm	0.0001
<i>Boundary Condition Parameters</i>			
CONSTBOUNDARY		–	false

Layer Parameters

Table 2-177. LAYER Composite Parameters

Parameter	Description	Units	Default
CON		–	1.42248
ConductionBandDOS		–	2.89e+19
DIEL		–	13.1
ELMOB0		–	2240
ELVSAT		–	7.7e+06
EMASS		–	0.067
GRADEDWIDTH		–	0
HMASS		–	0.5
HOMOBO		–	30
HOVSAT		–	7.7e+06
MATERIAL		–	'gaas'
NAME		–	'EMITTER'
NARCO		–	0.047
NARVA		–	0.047
NDOPE		–	0
NI		–	1.79e+06
NX		–	25
PDOPE		–	5e+19
VAL		–	0
ValenceBandDOS		–	2.66e+19
WIDTH		–	1e-06

Electrode Parameters 1D

Table 2-178. NODE Composite Parameters

Parameter	Description	Units	Default
AREA		–	0
BC	Carrier density boundary condition type (dirichlet or neumann)	–	'dirichlet'
LOCATION		–	0
MATERIAL	Contact material	–	'neutral'
NAME	Electrode name	–	'anode'
OXIDEBNDRYFLAG	Oxide layer boolean	–	false
SIDE	Side specification (left or right)	–	'left'

Electrode Parameters 2D

Table 2-179. NODE Composite Parameters

Parameter	Description	Units	Default
BC	Carrier density boundary condition type (dirichlet or neumann)	–	'dirichlet'
END	Ending location	cm	0
MATERIAL	Contact material	–	'neutral'
NAME	Electrode name	–	'anode'
OXCHARGE	Oxide charge	–	0
OXIDEBNDRYFLAG	Oxide layer boolean	–	false
OXTHICK	Oxide thickness	cm	0
SIDE	Side specification (top, bottom, left or right)	–	'top'
START	Starting location	cm	0

Doping or Region Parameters The DOPINGPROFILES and REGION parameters are synonyms, therefore their tables of values are identical. The use of both parameters in the same device instance could lead to unpredictable behavior.

Table 2-180. DOPINGPROFILES Composite Parameters

Parameter	Description	Units	Default
EL2		–	0
EXPRESSION	User-defined expressions for dopant profiles as function of depth	–	'none'
FILE		–	'none'
FLATX	Determines the doping shape (half-gaussian or a full gaussian)	–	0
FLATY	2D ONLY: Determines the doping shape (half-gaussian or a full gaussian)	–	0
FUNCTION	Functional form of doping region; options are uniform, gaussian, and step.	–	'uniform'
NAME		–	'none'
NMAX	Maximum value of impurity concentration	cm ⁻³	1e+15
NMAXCHOP		cm ⁻³	1e+20
NMIN	Minimum value of impurity concentration	cm ⁻³	0
SPECIES		–	'none'
TYPE	n _{type} or p _{type}	–	'n _{type} '
XLOC	Peak location of the doping in the x-direction	cm	0
XMAX		cm	0
XMIN		cm	0

Table 2-180. DOPINGPROFILES Composite Parameters



Parameter	Description	Units	Default
XWIDTH	Distance from nmax to nmin. This is only applicable for the function=gaussian case.	cm	0.001
YLOC	2D ONLY: Peak location of the doping in the y-direction ()	cm	0
YMAX	2D ONLY:	cm	0
YMIN	2D ONLY:	cm	0
YWIDTH	2D ONLY: Distance from nmax to nmin. This is only applicable for the function=gaussian case.	cm	0.001

Table 2-181. REGION Composite Parameters

Parameter	Description	Units	Default
EL2		–	0
EXPRESSION		–	'none'
FILE		–	'none'
FLATX	Determines the doping shape (half-gaussian or a full gaussian)	–	0
FLATY	2D ONLY: Determines the doping shape (half-gaussian or a full gaussian)	–	0
FUNCTION	Functional form of doping region; options are uniform, gaussian, and step.	–	'uniform'
NAME		–	'none'
NMAX	Maximum value of impurity concentration	cm ⁻³	1e+15
NMAXCHOP		cm ⁻³	1e+20
NMIN	Minimum value of impurity concentration	cm ⁻³	0
SPECIES		–	'none'
TYPE	ntype or ptype	–	'ntype'
XLOC	Peak location of the doping in the x-direction	cm	0
XMAX		cm	0
XMIN		cm	0
XWIDTH	Distance from nmax to nmin. This is only applicable for the function=gaussian case.	cm	0.001
YLOC	2D ONLY: Peak location of the doping in the y-direction ()	cm	0
YMAX	2D ONLY:	cm	0
YMIN	2D ONLY:	cm	0
YWIDTH	2D ONLY: Distance from nmax to nmin. This is only applicable for the function=gaussian case.	cm	0.001

Flat Parameters

Table 2-182. Description of the flatx, flaty doping parameters

Flatx or Flaty view	Description	1D Cross Section
0	Gaussian on both sides of the peak (x_{loc}) location.	
+1	Gaussian if $x > x_{loc}$, flat (constant at the peak value) if $x < x_{loc}$.	
-1	Gaussian if $x < x_{loc}$, flat (constant at the peak value) if $x > x_{loc}$.	

2.4.1. Physical Models

This section contains information about physical models used in Xyce for TCAD devices. This includes various mobility models, expressions for calculating the effective mass for electrons and holes, an expression for intrinsic carrier concentration as a function of temperature, expressions which describe contacts to metal as well as contacts to metal-oxide-semiconductor devices.

2.4.1.1. Material Models and Parameters

This section describes some of the basic material properties that are available in Xyce. Described here are the models for effective mass, intrinsic carrier concentration, and the bandgap. This information is needed for the more complex models described in the mobility section (section 2.4.2) and the boundary condition section (section 2.4.2.6).

2.4.1.2. Effective Mass

Xyce includes functions which return the effective mass of electrons and holes for a number of semiconductor materials.

2.4.1.3. Electron Effective Mass

The electron effective mass is calculated as

$$m_{de} = (m_l^* m_t^{*2})^{1/3} \quad (2.61)$$

where m_l and m_t are the effective masses along the longitudinal and transverse directions of the ellipsoidal energy surface.

2.4.1.4. Hole Effective Mass

The hole effective mass is calculated as

$$m_{dh} = (m_{lh}^{*3/2} + m_{hh}^{*3/2})^{2/3} \quad (2.62)$$

where m_{lh} and m_{hh} are the "light" and "heavy" hole masses, respectively.

2.4.1.5. Intrinsic Carrier Concentration

The intrinsic carrier concentration in a semiconductor is obtained from the "np" product

$$np = n_i^2 = N_C N_V \exp(-E_g/kT) \quad (2.63)$$

or

$$n_i = \sqrt{N_C N_V} e^{-E_g/2kT} \quad (2.64)$$

The expression used in Xyce to calculate the intrinsic carrier concentration comes from this and is given by

$$n_i = 4.9 \times 10^{15} \left(\frac{m_{de} m_{dh}}{m_0^2} \right)^{3/4} M_c^{1/2} T^{3/2} e^{-E_g/2kT} \quad (2.65)$$

where M_c is the number of equivalent minima in the conduction band for the semiconductor, m_{de} is the density-of-state effective mass for electrons, m_{dh} is the density-of-state effective mass for holes, and m_0 is the free-electron mass.

Table 2-183. Intrinsic Carrier Concentration Parameters

Semiconductor	Symbol	$M_c^{1/2}$	n_i at room temperature
Silicon	si	$\sqrt{6.00}$	1.25×10^{10}
Germanium	ge	2.00	2.5×10^{13}
Galium Arsenide	gaas	1.00	2.0×10^6

2.4.1.6. Bandgap

The bandgap is a material and temperature-dependent quantity. The bandgap model for semiconductor materials, is based on Thurmond [42]. This model is given by:

$$E_g = E_{g0} - A * \left(\frac{T^{2.0}}{T + T_{off}} \right) \quad (2.66)$$

where E_g is the bandgap (eV) and T is the temperature (K). A , E_{g0} , and T_{off} are all material-dependent constants. Insulating materials, such as silicon dioxide, are assumed to have constant bandgaps, so their bandgaps are given by:

$$E_g = E_{g0} \quad (2.67)$$

where E_{g0} is a material-dependent constant. The values for the material-dependent constants used by equations 2.66 and 2.67 are given in Table 2-184.

Table 2-184. Bandgap constants

Material	Symbol	E_{g0} (eV)	A	T_{off} (K)
Silicon	si	1.17	4.73e-4	636.0
Germanium	ge	0.7437	4.774e-4	235.0
Galium Arsenide	gaas	1.519	5.405e-4	204.0
Silicon Dioxide	sio2	9.00	NA	NA
Silicon Nitride	wdi	4.7	NA	NA
Sapphire	cu	4.7	NA	NA

2.4.2. Mobility Models

A number of mobility models are included in Xyce. The analytic, arora, and carrier-carrier scattering models are considered to be low-field mobility models. The Lombardi surface mobility model is a transverse-field dependent model which also incorporates the mobility of the bulk silicon.

2.4.2.1. Analytic Mobility

This is a concentration- and temperature-dependent empirical mobility model, based on the work of Caughey and Thomas [43], which combines the effects of lattice scattering and ionized impurity scattering. The equation for the mobility of electrons is:

$$\mu_{0n} = \mu_{nmin} + \frac{\mu_{nmax} \left(\frac{T}{T_{ref}}\right)^{nun} - \mu_{nmin}}{1 + \left(\frac{T}{T_{ref}}\right)^{xin} (N_{total}/N_n^{ref})^{\alpha_n}} \quad (2.68)$$

and the equation for the mobility of holes is:

$$\mu_{0p} = \mu_{pmin} + \frac{\mu_{pmax} \left(\frac{T}{T_{ref}}\right)^{nup} - \mu_{pmin}}{1 + \left(\frac{T}{T_{ref}}\right)^{xip} (N_{total}/N_p^{ref})^{\alpha_p}} \quad (2.69)$$

where N_{total} is the local total impurity concentration (in $\#/cm^3$), T_{ref} is a reference temperature (300.15K), and T is the temperature (in degrees K). The parameters N_n^{ref} and N_p^{ref} are reference values for the doping concentration. The analytic mobility model can be selected by using the statement "mobmodel=analytic" in the netlist.

The parameters for the analytic mobility model are given in Table 2-185.

Table 2-185. Analytic Mobility Parameters

Parameter	Silicon	GaAs
μ_{nmin}	55.24	0.0
μ_{nmax}	1429.23	8500.0
N_n^{ref}	1.072e17	1.69e17
nun	-2.3	-1.0
xin	-3.8	0.0
α_n	0.73	0.436
μ_{pmin}	49.70	0.0
μ_{pmax}	479.37	400.0
N_p^{ref}	1.606e17	2.75e17
nup	-2.2	-2.1
xip	-3.7	0.0
α_p	0.70	0.395

2.4.2.2. Arora Mobility

This mobility model is also an analytic model which depends on impurity concentration and temperature. It comes from the work of Arora, *et al.* [44] and is based on both experimental data and the modified Brooks-Herring theory of mobility. The equation for the mobility of electrons is:

$$\mu_{0n} = \mu_{n1} \left(\frac{T}{T_{ref}} \right)^{expn1} + \frac{\mu_{n2} \left(\frac{T}{T_{ref}} \right)^{expn2}}{1 + \left(\frac{N_{total}}{Cn \left(\frac{T}{T_{ref}} \right)^{expn3}} \right)^{\alpha_n}} \quad (2.70)$$

and the equation for the mobility of holes is:

$$\mu_{0p} = \mu_{p1} \left(\frac{T}{T_{ref}} \right)^{exp1} + \frac{\mu_{p2} \left(\frac{T}{T_{ref}} \right)^{exp2}}{1 + \left(\frac{N_{total}}{Cp \left(\frac{T}{T_{ref}} \right)^{exp3}} \right)^{\alpha_p}} \quad (2.71)$$

where

$$\alpha_n = An \left(\frac{T}{T_{ref}} \right)^{expn4} \quad (2.72)$$

and

$$\alpha_p = Ap \left(\frac{T}{T_{ref}} \right)^{exp4} \quad (2.73)$$

The Arora mobility model can be selected by including the statement "mobmodel=arora" in the netlist. The parameters for the arora mobility model are given in Table 2-186.

Table 2-186. Arora Mobility Parameters

Parameter	Silicon	GaAs
μ_{n1}	88.0	8.5e3
μ_{n2}	1252.0	0.0
Cn	1.26e17	1.26e17
An	0.88	0.0
exn1	-0.57	-0.57
exn2	-2.33	0.0
exn3	2.4	0.0
exn4	-0.146	0.0
μ_{p1}	54.3	4e2
μ_{p2}	407.0	0.0
Cp	2.35e17	2.35e17
Ap	0.88	0.0
exp1	-0.57	0.0
exp2	-2.23	0.0
exp3	2.4	0.0
exp4	-0.146	0.0

2.4.2.3. Carrier-Carrier Scattering Mobility

This mobility model is based on the work of Dorkel and Leturq [45]. It incorporates carrier-carrier scattering effects, which are important when high concentrations of electrons and holes are present in the device. This model also takes lattice scattering and ionized impurity scattering into account. One important difference between the carrier-carrier scattering mobility model and the two previous mobility models (analytic and arora models) is that the carrier-carrier scattering mobility model depends upon the actual carrier concentrations in the device. This model is important for modeling breakdown as well as various radiation effects, which often result in very high carrier densities.

The expressions for the carrier-carrier model are as follows:

$$\mu_L = \mu_{L0} \left(\frac{T}{T_{ref}} \right)^{-\alpha} \quad (2.74)$$

where μ_L is the lattice mobility, which has to do with scattering due to acoustic phonons.

$$\mu_I = \frac{AT^{3/2}}{N} \left[\ln \left(1 + \frac{BT^2}{N} \right) - \frac{BT^2}{N + BT^2} \right]^{-1} \quad (2.75)$$

where μ_I is the impurity mobility which is related to the interactions between the carriers and the ionized impurities.

$$\mu_{ccs} = \frac{2 \times 10^{17} T^{3/2}}{\sqrt{pn}} [\ln(1 + 8.28 \times 10^8 T^2 (pn)^{-1/3})]^{-1} \quad (2.76)$$

where μ_{ccs} is the carrier-carrier scattering mobility, which is very important when both types of carriers are at high concentration.

$$X = \sqrt{\frac{6\mu_L(\mu_I + \mu_{ccs})}{\mu_I\mu_{ccs}}} \quad (2.77)$$

is an intermediate term and

$$\mu = \mu_L \left[\frac{1.025}{1 + (X/1.68)^{1.43}} - 0.025 \right] \quad (2.78)$$

is the carrier mobility. The carrier-carrier scattering mobility can be selected by including the statement "mobmobel=carr" in the netlist. The parameters for the carrier-carrier mobility model are given in Table 2-187.

Table 2-187. Carrier-Carrier Mobility Parameters

Parameter	Carrier	Silicon	GaAs
Al	e^-	1430.0	8.50e3
Bl	e^-	-2.2	0.0
Ai	e^-	4.61e17	4.61e17
Bi	e^-	1.52e15	1.52e15
Al	h^+	495.0	4.0e2
Bl	h^+	-2.2	0.0
Ai	h^+	1.00e17	1.00e17
Bi	h^+	6.25e14	6.25e14

2.4.2.4. Lombardi Surface Mobility Model

This mobility model combines expressions for mobility at the semiconductor-oxide interface and in bulk silicon. It is based on the work of Lombardi *et al.* [46]. The overall mobility is found using Mathiessen's rule:

$$\frac{1}{\mu} = \frac{1}{\mu_{ac}} + \frac{1}{\mu_b} + \frac{1}{\mu_{sr}} \quad (2.79)$$

where μ_{ac} is the carrier mobility due to scattering with surface acoustic phonons, μ_b is the carrier mobility in bulk silicon, and μ_{sr} is the carrier mobility limited by surface roughness scattering.

The Lombardi model is a more physics-based surface mobility model. It is a semi-empirical model for carrier mobility, and the expressions for the individual scattering mechanisms were extracted from experimental data taken in appropriate experimental conditions.

The expressions used in this model are given below:

$$\mu_{ac,n} = \frac{bn}{E_{\perp}} + \frac{cnN^{exp4}}{T(E_{\perp})^{1/3}} \quad (2.80)$$

is the expression for electron mobility for acoustic phonon scattering,

$$\mu_{ac,p} = \frac{bp}{E_{\perp}} + \frac{cpN^{exp4}}{T(E_{\perp})^{1/3}} \quad (2.81)$$

is the expression for hole mobility for acoustic phonon scattering,

$$\mu_{b,n} = \mu_{n0} + \frac{\mu_{max,n} - \mu_{n0}}{1 + (N/crn)^{exp1}} - \frac{\mu_{n1}}{1 + (csn/N)^{exp2}} \quad (2.82)$$

is the expression for bulk mobility for electrons, where

$$\mu_{max,n} = \mu_{n2} \left(\frac{T}{T_{ref}} \right)^{-exn3} \quad (2.83)$$

and

$$\mu_{b,p} = \mu_{p0} \exp(-pc/N) + \frac{\mu_{max,p}}{1 + (N/crp)^{exp1}} - \frac{\mu_{p1}}{1 + (csp/N)^{exp2}} \quad (2.84)$$

is the expression for bulk mobility for holes, where

$$\mu_{max,p} = \mu_{p2} \left(\frac{T}{T_{ref}} \right)^{-exp3} \quad (2.85)$$

The expression for electrons for surface roughness scattering is

$$\mu_{sr,n} = \left(\frac{dn}{E_{\perp}^{exn8}} \right) \quad (2.86)$$

and the expression for holes for surface roughness scattering is

$$\mu_{sr,p} = \left(\frac{dp}{E_{\perp}^{exp8}} \right) \quad (2.87)$$

The parameters for the lombardi surface mobility model are given in Table2-188.

Table 2-188. Lombardi Surface Mobility Parameters

Parameter	Silicon	GaAs
μ_{n0}	52.2	0.0
μ_{n1}	43.4	0.0
μ_{n2}	1417.0	1e6
crn	9.68e16	9.68e16
csn	3.43e20	0.0
bn	4.75e7	1e10
cn	1.74e5	0.0
dn	5.82e14	1e6
exn1	0.680	0.0
exn2	2.0	0.0
exn3	2.5	0.0
exn4	0.125	0.0
exn8	2.0	0.0
μ_{p0}	44.9	0.0
μ_{p1}	29.0	0.0
μ_{p2}	470.5	1.0
crp	2.23e17	2.23e17
csp	6.1e20	0.0
bp	9.93e6	1e10
cp	8.84e5	0.0
dp	2.05e14	1e6
exp1	0.719	0.0
exp2	2.0	0.0
exp3	2.2	0.0
exp4	0.0317	0.0
exp8	2.0	0.0
pc	9.23e16	0.0

2.4.2.5. Edge Mobilities

Mobility values are calculated along the edge connecting two nodes. In the case of the analytic, arora, and surface mobility models, the edge mobilities are calculated by taking the average of the mobilities at the two nodes. Then, the mobility along the edge connecting nodes 1 and 2 is:

$$\mu_{edge} = (\mu[1] + \mu[2])/2.0 \quad (2.88)$$

In the case of the carrier-carrier scattering mobility, the edge mobilities were calculated differently. The electron and hole concentrations were first calculated at the midpoint of the edge using a "product" average and then these values of "n" and "p" were used in the function to calculate the mobility at the midpoint of the edge. For example, if $n[1]$ and $n[2]$ are the electron concentrations at nodes 1 and 2, the electron concentration along the edge is given by:

$$n_{edge} = \sqrt{n[1] * n[2]} \quad (2.89)$$

Subsequently, the mobility at the midpoint of an edge is found by using the values of electron and hole concentration at the midpoint of the edge when calling the function which returns the mobility, `calcMob()`.

$$\mu_{n,edge}^{carrier} = f(n_{edge}) \quad (2.90)$$

This method makes more sense, especially when the electron and hole concentrations vary by several orders of magnitude. Then it approximates taking the average of the logarithms.

2.4.2.6. Boundary Conditions for Electrode Contacts

This section describes various boundary conditions that need to be applied to the semiconductor boundary. Xyce is predominantly an analog circuit simulator, and the TCAD (PDE-based) device modeling that has been implemented in Xyce takes external circuit information as input. This input consists of voltages and currents which are applied as boundary conditions to the semiconductor domain.

The physical connection from the circuit to the device generally includes a variety of materials, including metals and oxides. Electrical differences between the semiconductor and the contact material can result in a potential barrier that must be included in the imposed voltage boundary condition.

There are three general types of contacts between the circuit and the TCAD device that are handled by Xyce. The first is the "neutral" contact, in which it is simply assumed that the electrode material does not impose any additional potential barrier to that of the Fermi level differences in the semiconductor. The second is the Schottky contact, in which the electrode is a specified metal, and a potential barrier is imposed to account for the workfunction difference between the metal and the semiconductor. The last type of contact is the metal-oxide-semiconductor contact, in which the workfunction difference, and the voltage drop across the oxide must be accounted for.

2.4.2.7. Neutral Contacts

A neutral contact refers to the case in which the contact is made to the semiconductor itself, and barrier heights due to material differences are not considered. This is the simplest type of contact in Xyce, and problems which use this type of contact are generally easier to solve, compared with other types of contacts. In this case, the boundary is given by

$$V_{bc} = V_{ckt} + V_{bi} \quad (2.91)$$

where V_{ckt} is the potential applied by the circuit and V_{bi} is the "built-in" potential of the semiconductor. For a p-type substrate, the built-in potential is given by

$$V_{bi} = -\frac{kT}{q} \ln\left(\frac{N_A}{n_i}\right) \quad (2.92)$$

and for an n-type substrate, the built-in potential is given by

$$V_{bi} = \frac{kT}{q} \ln\left(\frac{N_D}{n_i}\right) \quad (2.93)$$

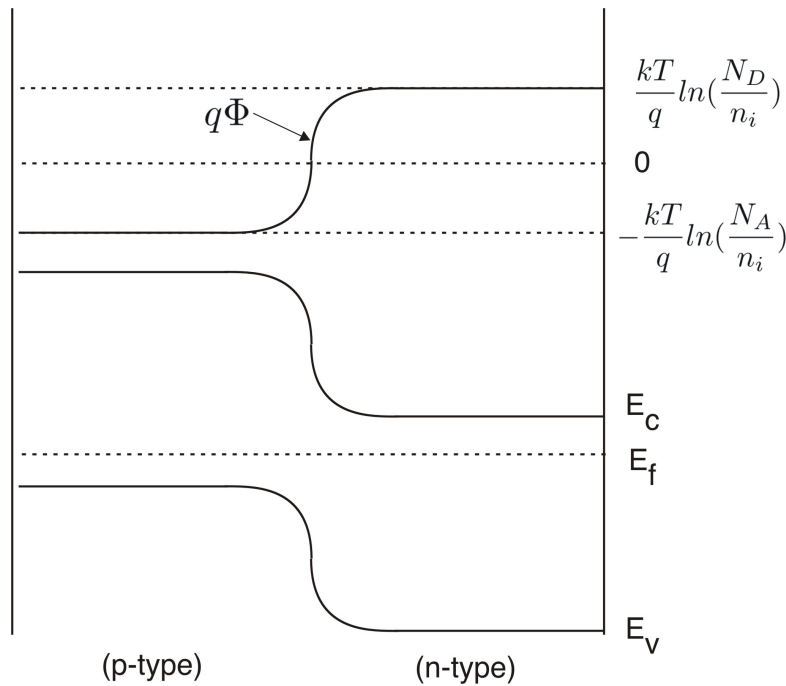

Figure 2-8. Neutral Contacts.

V_{bi} represents the extent of the energy band bending due to the doping of a device. While most of the dramatic changes will happen away from the contact, near junctions, it is still incorporated into the voltage boundary condition to maintain a flat potential near the contacts. Figure 2-8 shows the energy band variation across a PN junction, and the corresponding electrostatic potential. This variation is due to the internal physics of the device, and needs to be there even in the event of zero applied voltage. This is partially enforced by the solution to Poisson's equation, and also by the application of equation 2.91.

2.4.2.8. Schottky Contacts

In the case of a metal-semiconductor contact, it is necessary to add the workfunction difference, Φ_{ms} , to the potential in the semiconductor [47]. Φ_m is a constant for a given metal, and Φ_s is a function of the doping in the semiconductor. The workfunction potential, Φ , when multiplied by q , is the difference between the Fermi level and vacuum in the material. In essence, the workfunction difference represents the distance

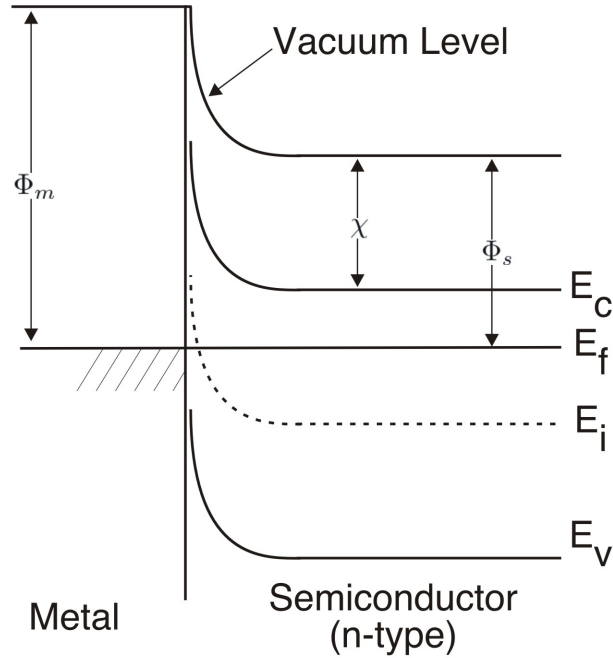

Figure 2-9. Schottky Contact, N-type.

between the Fermi level in the metal and the Fermi level in the semiconductor when considering the individual band structures.

In the case of an n-type semiconductor, the semiconductor workfunction can be represented as

$$\Phi_s = \chi + (E_C - E_{FS})/q \quad (2.94)$$

where χ is the electron affinity in the semiconductor and $q\chi$ is the distance between the conduction band and vacuum in the semiconductor. E_C is the conduction band energy and E_{FS} is the Fermi level of the semiconductor. Rewriting this expression in terms of the doping concentration, it becomes

$$\Phi_s = \chi + E_g/2 - V_t \ln\left(\frac{N_d}{n_i}\right) \quad (2.95)$$

In the case of a p-type semiconductor, the semiconductor workfunction can be represented as

$$\Phi_s = \chi + E_g/2 + (E_i - E_{FS})/q \quad (2.96)$$

where E_i is the intrinsic value of the Fermi level, and can be approximated as the halfway point between the conduction band (E_C) and the valance band (E_V). Rewriting this expression in terms of the doping concentration

$$\Phi_s = \chi + E_g/2 + V_t \ln\left(\frac{N_a}{n_i}\right) \quad (2.97)$$

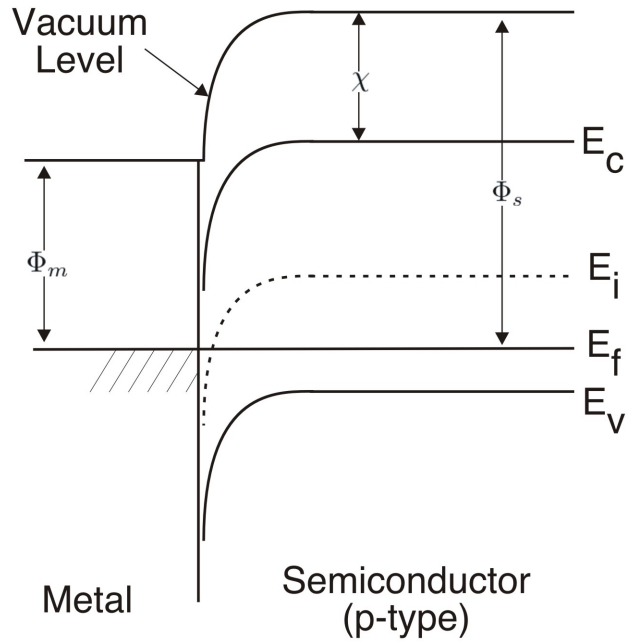

Figure 2-10. Schottky Contact, P-type.

For the TCAD devices in Xyce, for a node at a metal-semiconductor contact, the quantity $\Phi_m - \Phi_s$ is added to the potential at the node to account for the metal-semiconductor barrier. The current values of metal workfunctions used in Xyce are given in Table 2-189. The values for electron affinity are given in Table 2-190. The boundary condition for a metal electrode in Xyce is given by

$$V_{bc} = V_{ckt} + V_{bi} + \Phi_{ms} \quad (2.98)$$

where V_{ckt} is the potential applied by the circuit to the electrode and V_{bi} is the "built-in" potential of the semiconductor, a function of the semiconductor doping.

Table 2-189. Material workfunction values

Metal	Symbol	Workfunction, Φ_m (Volts)
aluminum	al	4.10
p+-polysilicon	ppoly	5.25
n+-polysilicon	npoly	4.17
molybdenum	mo	4.53
tungsten	w	4.63
molybdenum disilicide	modi	4.80
tungsten disilicide	wdi	4.80
copper	cu	4.25
platinum	pt	5.30
gold	au	4.80

Table 2-190. Electron affinities

Semiconductor	Symbol	Electron Affinity, χ (Volts)
Silicon	si	4.17
Germanium	ge	4.00
Galium Arsenide	gaas	4.07
Silicon Dioxide	sio2	0.97
Nitride	nitride	0.97
Sapphire	sapphire	0.97

2.4.2.9. Metal-Oxide-Semiconductor Contacts

To date in Xyce, only semiconductor material is included in the PDE solution domain. Metals and oxide materials are only included through boundary conditions. This is an adequate approach for a lot of problems. For some problems (such as modeling of low-dose radiation effects) modeling the oxide in more detail, as a PDE, will become necessary. However, since oxides are usually very thin, compared with the semiconductor domain, meshing both materials as part of the same simulation is difficult. Therefore, incorporating the effects of a gate oxide as part of the gate boundary condition is a reasonable approach.

In the case of a contact to a metal-oxide-semiconductor structure, the separation of the Fermi energies in the metal and the semiconductor at equilibrium is due to two effects: the workfunction difference between the metal and the semiconductor, and the effective interface charge. These two effects cause the bands to bend at the surface in equilibrium. The flatband voltage is the sum of these two terms [47]:

$$V_{FB} = \Phi_{ms} - \frac{Q_i}{C_i} \quad (2.99)$$

where Φ_{ms} is the metal-semiconductor workfunction difference, Q_i is the value of interface charge (in C/cm^2), and C_i is the oxide capacitance per unit area, which is given by

$$C_i = \frac{\epsilon_{ox}\epsilon_0}{x_o} \quad (2.100)$$

The voltage V_{FB} is the amount of bias which, when applied to the gate, causes the electron energy bands to be flat. This is the potential that is added to a boundary node in Xyce to account for a metal-oxide-semiconductor barrier. The overall boundary condition for a contact to a metal-oxide-semiconductor structure is given by

$$V_{bc} = V_{ckt} + V_{bi} + \Phi_{ms} - Q_i/C_i \quad (2.101)$$

where V_{ckt} is the potential applied by the circuit and V_{bi} is the "built-in" potential of the semiconductor.

2.4.2.10. NMOS Device

The default NMOS device used in Xyce has a substrate doping concentration of $1.0 \times 10^{16}/cm^3$ and an oxide thickness of $1.0 \times 10^{-6}cm$. Since the ideal threshold voltage V_T is given by

$$V_T = 2\phi_F + \frac{\epsilon_s}{\epsilon_{ox}} x_o \sqrt{\frac{2qN_A\phi_F}{\epsilon_s\epsilon_0}} \quad (2.102)$$

V_T is equal to 0.892 V. for this device. Note that

$$\phi_F = \frac{1}{q} [E_i(bulk) - E_F] = \frac{kT}{q} \ln\left(\frac{N_A}{n_i}\right) \quad (2.103)$$

for a p-type semiconductor substrate and

$$\phi_F = -\frac{kT}{q} \ln\left(\frac{N_D}{n_i}\right) \quad (2.104)$$

for an n-type substrate.

This page intentionally left blank.

3. COMMAND LINE ARGUMENTS

Xyce supports a handful of command line arguments which must be given *before* the netlist filename. While most of these are intended for general use, others simply give access to new features that, while supported, are not enabled by default. The general usage is as follows:

Xyce [arguments] <netlist filename>

Table 3-1 gives a list of supported command line options.¹

Table 3-1. List of Xyce command line arguments.

Argument	Description	Usage	Default
-h	Help option. Prints usage and exits.	-h	-
-v	Prints the version banner and exits.	-v	-
-license	Prints the license text and exits.	-license	-
-capabilities	Prints a list of compiled-in options and exits.	-capabilities	-
-delim	Set the output file field delimiter.	-delim <TAB COMMA SEMICOLON COLON string>	-
-o	Place the output result(s) into file(s) with the specified basename and the appropriate extension (e.g., <basename>.prn or <basename>.mt0).	-o <basename>	output file name(s) based on netlist file name.
-l	Place the log output into specified file.	-l <file>	Log output sent to standard out.
-r	Output a binary rawfile.	-r <file>	No rawfile written.
-a	Use with -r to output a readable (ASCII) rawfile. Without the concurrent use of -r, -a will cause all .PRINT lines that use FORMAT=RAW to produce ASCII rawfiles.	-r <file> -a -a	Default rawfile is binary.
-nox	Use the NOX nonlinear solver.	-nox <ON OFF>	on
-linsolv	Set the linear solver.	-linsolv <KLU KSPARSE SUPERLU AZTECO0 BELOS>	KLU for serial and small circuits in parallel. Aztec00 for large circuits in parallel.

¹Note that the “-h” option might list command line options not present in this table. These extra options are generally deprecated and should not be used. Only the options listed in the table are considered supported features.

Table 3-1. List of Xyce command line arguments.

Argument	Description	Usage	Default
-param	Print a terse summary of model and/or device parameters, and default values.	-param	-
-prf	Specify a file with simulation parameters.	-prf <filename>	-
-rsf	Specify a file to save simulation responses functions.	-rsf <filename>	-
-remeasure	Recompute .measure and/or .fft results with existing data.	-remeasure	-
-syntax	Check netlist syntax then exit.	-syntax	-
-norun	Check netlist syntax and topology, then exit.	-norun	-
-quiet	Suppress some of the simulation-progress messages sent to stdout for transient simulations.	-quiet	-
-namesfile	Output a list of all solution variables generated by the netlist into <filename>	-namesfile <filename>	-
-noise_names_file	Output a list of all noise sources for all devices generated by the netlist into <filename>	-noise_names_file <filename>	-
-randseed	Set random number seed for expression library's random number functions and also .SAMPLING analysis	-randseed <number>	If not provided, Xyce will generate a seed internally.
-maxord	Maximum time integration order.	-maxord <1..5>	-
-max-warnings	Maximum number of warning messages.	-max-warnings <#>	100
-jacobian_test	Jacobian matrix diagnostic.	-jacobian_test	-
-redefined_params	Set precedence for multiply defined parameters. Can be set to ignore (use last), usefirst, warn or error.	-redefined_params <option>	ignore, which means use the last duplicate parameter in the netlist without warning or error.
-hspice-ext	Hspice parser extensions. This will override several parser issues that are difficult to translate with scripts.	-hspice-ext <all separator units math>	The second argument will determine which features are enabled. For details see section 3.1.

A few other command line options are available that are typically only used in Xyce development. For example the options -param, -info, -doc and -doc_cat are used to generate the device tables in this guide. The options -jacobian_test and -namesfile can be useful in debugging new devices in Xyce.

The option `-namesfile` is also useful for determining the “fully qualified node names”, including the subcircuit hierarchy, for nodes and internal variables for mutual inductors. The `.PRINT` section 2.1.31 has more information on, and examples for, the `-namesfile` command line option.

3.1. Hspice extensions

The command line argument `-hspice-ext` is more complicated than most, so its explanation is given in this section. The second argument to `-hspice-ext` can either be a single string or can be a comma separated list.

- Using `all` will enable all the features.
- Using `units` sets the use of the “atto” prefix, designated by “a”, to mean a multiplier of “1E-18”. Without this setting, the “a” prefix means units of amperes.
- Using `math` sets the use of Hspice style math operators. Most importantly, it forces “log” to mean the natural logarithm, rather than the base 10 logarithm.
- Using `separator` sets the use of the period “.” for subcircuit name separation. If this is not set, the colon “:” is used instead.

3.2. Redefined parameters

Xyce, like most circuit simulators, permits multiple parameters of the same name in a netlist. However, when multiple parameters have the same name, the default behavior of Xyce may differ from other codes. The `-redefined_params` command line option can be used to ensure compatibility. The available options are the following:

- `ignore` is the default behavior, and will result in Xyce using the last parameter found in the netlist, while emitting no warnings.
- `uselast` is synonymous with `ignore`.
- `error` will result in Xyce exiting with a fatal error if multiple parameters have the same name.
- `warn` will result in Xyce behaving the same as the default behavior (using the last parameter) but will emit a warning for every duplicate parameter to the terminal.
- `warning` is synonymous with `warn`.
- `uselastwarn` is synonymous with `warn`.
- `usefirst` will result in Xyce using the first parameter of a given name in the netlist, without warnings or errors. This is the behavior of some other simulators.
- `usefirstwarn` is the same as `usefirst`, except that it will emit a warning for every duplicate parameter to the terminal.

The options that emit warnings or error messages to terminal output can result in very verbose output for large circuits. For that reason warnings are not enabled as the default behavior. However, these options can be useful for debugging netlists.

This page intentionally left blank.

4. RUNTIME ENVIRONMENT

4.1. Running Xyce in Serial

After ensuring that the directory into which Xyce was installed is in your PATH variable, one merely executes the code by running the command, Xyce with the desired netlist name appended.

4.2. Running Xyce in Parallel

Open MPI must be installed on the host machine. It may be download from

<http://www.open-mpi.org/>. Consult the documentation for help with installation.

After ensuring that the both the directory into which Xyce was installed and the directory in which mpirun is found are in your PATH variable, one merely executes the code by running the command, `mpirun [mpirun options] Xyce [xyce options]` with the desired netlist name appended.

4.3. Running Xyce on Sandia HPC and CEE Platforms

This version of Xyce has been installed centrally on Sandia HPC and CEE platforms, and requires metagroup access. Contact the Xyce team for details on how to obtain this access.

Once you have registered for metagroup membership, the central installs of Xyce may be accessed by a module load.

`module load Xyce` adds all required modules and sets all required environment variables to access the normal version of Xyce. `module load XyceRad` does the same thing for the version Xyce containing Sandia proprietary models.

`module help Xyce` provides some additional information about what the module does.

Consult the system documentation for help with submitting jobs on these platforms.

<https://computing.sandia.gov/>

This page intentionally left blank.

5. SETTING CONVERGENCE PARAMETERS FOR XYCE

Because the solution algorithms and methods within Xyce are different than those used by other circuit simulation tools (e.g., SPICE), the overall convergence behavior is sometimes different, as are the parameters which control this behavior.

5.1. Adjusting Transient Analysis Error Tolerances

Xyce uses a variable order trapezoid integration as its default scheme, and this method may also be requested explicitly with the **TIMEINT** option **METHOD=trap** or **METHOD=7**. Trapezoid time-stepping is second order accurate and does not have any numerical dissipation in its local truncation error. Variable order trapezoid integration dynamically uses Backward Euler (BE) and trapezoid rule. When **ERROPTION=1** is set with **METHOD=7**, trapezoid rule is used almost exclusively (BE only used at breakpoints). See table 2-5 for details.

Another time integration option is the second-order Gear method. It may be selected with the **TIMEINT** option **METHOD=gear** or **METHOD=8**. See table 2-5 for details.

5.1.1. Setting *RELTOL* and *ABSTOL*

In Xyce, both the time integration package and the nonlinear solver package have **RELTOL** and **ABSTOL** settings. Some general guidelines for settings parameters are [48]:

- Use the *same* **RELTOL** and **ABSTOL** values for both the **TIMEINT** and the **NONLIN-TRAN .OPTIONS** statements.
- For a conservative approach (i.e., safe), set $RELTOL = 1.0E^{-(m+1)}$ where m is the desired number of significant digits of accuracy.
- Set **ABSTOL** to the smallest value at which the solution components (either voltage or current) are essentially insignificant.
- Note that the above suggests that **ABSTOL** < **RELTOL**.

The current defaults for these parameters are **ABSTOL**=1.0E-6 and **RELTOL** = 1.0E-3. For a complete list of the time integration parameters, see chapter 2.1.

5.2. Adjusting Nonlinear Solver Parameters (in transient mode)

In Xyce, the nonlinear solver options for transient analysis are set using the `.OPTIONS NONLIN-TRAN` line in a netlist. This subsection gives some guidelines for setting these parameters.

- For guidelines on setting **RELTOL** and **ABSTOL**, see above.
- **RHSTOL** – This is the maximum residual error for each nonlinear solution. Xyce uses this as a “safety” check on nonlinear convergence. Typically, $1.0E-2$ (the default) works well.
- **DELTAXTOL** – This is the weighted update norm tolerance and is the primary check for nonlinear convergence. Since it is weighted (i.e., normalized using **RELTOL** and **ABSTOL**), a value of 1.0 would give it the same accuracy as the time integrator. For robustness, the default is 0.33 but sometimes a value of 0.1 may help prevent “time-step too small” errors. A value of 0.01 is considered quite small.
- **MAXSTEP** – This is the maximum number of Newton (nonlinear) steps for each nonlinear solve. In transient analysis, the default is 20 but can be increased to help prevent “time-step too small” errors. This is roughly equivalent to **ITL4** in SPICE.

6. QUICK REFERENCE FOR USERS OF OTHER SPICE CIRCUIT SIMULATORS

This chapter describes many of the differences between Xyce and other SPICE-like circuit simulators. The primary focus is on the difference between Orcad PSpice and Xyce, with an eye towards providing the ability for those familiar with using PSpice to begin using Xyce quickly. PSpice compatibility was an early focus for the Xyce project.

The Xyce team also supports a netlist translation tool, XDM (for Xyce Data Model) [49]. This tool supports translation of netlists in Pspice, Hspice and Spectre format into Xyce formatted netlist files. There is also a Xyce command line option (`-hspice-ext all`) which is designed to assist with a handful of Hspice syntax issues that are particularly difficult to translate.

This chapter is likely not complete, and Xyce users might also consult specific sections of this Reference Guide about particular Xyce commands. Those sections may have additional information on Xyce's incompatibilities with other circuit simulators, and how to work around them.

6.1. Differences Between Xyce and PSpice

This section is focused on the differences between Xyce and PSpice. However, some of this discussion also applies to other SPICE-like circuit simulators.

6.1.1. *Command Line Options*

Command line arguments are supported in Xyce but they are different than those of PSpice. For a complete reference, see Chapter 3.

6.1.2. *Device Support*

Most, but not all, devices commonly found in other circuit simulation tools are supported. Xyce also contains enhanced versions of many semiconductor devices that simulate various environmental effects. For the complete list, please see the Analog Device Summary in Table 2-35.

6.1.3. *.OPTIONS Support*

For the specific devices or models that are supported in Xyce, most of the standard netlist inputs are the same as those in standard SPICE. However, the **.OPTIONS** command has several additional features used to expose capabilities specific to Xyce. In particular, Xyce does not support the standard PSpice format **.OPTIONS** line in netlists. Instead, options for each supported package are called according to the following format.

General Form `.OPTIONS <pkg> [<tag>=<value>]*`

Arguments and Options

`DEVICE`
 Device Model

`TIMEINT`
 Time Integration

`NONLIN`
 Nonlinear Solver

`NONLIN-TRAN`
 Transient Nonlinear Solver

`NONLIN-HB`
 HB Nonlinear Solver

`LOCA`
 Continuation/Bifurcation Tracking

`LINSOL`
 Linear Solver

`LINSOL-HB`
 HB Linear Solver

`OUTPUT`
 Output

`RESTART`
 Restart

`HBINT`
 Harmonic Balance (HB)

`SENSITIVITY`
 Direct and Adjoint sensitivity analysis

For a complete description of the supported options in Xyce, see section 2.1.25.

Known caveats are that the `ABSTOL` options have different definitions in PSpice and Xyce. Also, a PSpice `.OPTIONS VNTOL=<value>` line can be mapped into these two Xyce lines:

```
.OPTIONS NONLIN ABSTOL=<value>
.OPTIONS NONLIN_TRAN ABSTOL=<value>
```

The PSpice `ITL1` and `ITL4` options are similar to the Xyce `MAXSTEPS`. In PSpice, `ITL1` affects `.DC` analyses, while `ITL4` affects `.TRAN` analyses. In Xyce, `.OPTIONS NONLIN` refers to options for `.DC` analyses, while `.OPTIONS NONLIN-TRAN` refers to options for `.TRAN` analyses. So, a feasible mapping is PSpice `.OPTIONS ITL1=20` becomes `.OPTIONS NONLIN MAXSTEP=20` in Xyce. Similarly, PSpice `.OPTIONS ITL4=20` becomes `.OPTIONS NONLIN-TRAN MAXSTEP=20` in Xyce. However, given that PSpice and Xyce use different default values for `ITL1` and `ITL4` vs. `MAXSTEPS`, the best approach may be to not translate the `ITL1` and `ITL4` lines into the corresponding Xyce netlist.

6.1.4. **.PROBE vs. .PRINT**

Xyce does not support the “**.PROBE**” statement. Output of Probe-format files, in .csd format, that are readable by PSpice is done using the **.PRINT** netlist statement. See section 2.1.31 for the syntax for **FORMAT=PROBE**. That section also describes wildcard support and access to subcircuit nodes in Xyce, both of which are different than PSpice.

Xyce does not support PSpice style abbreviations in the **.PRINT** statement. For example, to print out the value of the voltage at node A in a transient simulation you must request **.PRINT TRAN V(A)**, not **.PRINT TRAN A**. Xyce also does not support **N()** as a synonym for **V()** on **.PRINT** lines.

6.1.5. **Converting PSpice ABM Models for Use in Xyce**

Xyce is almost fully compatible with PSpice with respect to analog behavioral models. This includes the E, F, G, and H device types. A notable exception to this compatibility is in the use of lead and device currents in expressions used in controlled source definitions. That feature is not supported in Xyce. In addition, the **FREQ,LAPLACE** and **CHEBYSHEV** forms for E and G sources or the **ERROR** qualifier are not supported in Xyce..

6.1.6. **Usage of .STEP Analysis**

The implementation of **.STEP** in Xyce is not the same as that of PSpice. See section 2.1.36 for the syntax and function of the **.STEP** function in Xyce.

6.1.6.1. **Model Parameter Sweeps**

PSpice requires extra keywords to apply a **.STEP** statement to a model parameter. Xyce handles model parameters differently, and is actually somewhat more flexible than PSpice. Unfortunately, this means that the two specifications are not compatible.

A model parameter in PSpice would be handled like this:

```
R1 1 2 RMOD 1
.model RMOD RES(R=30)
.step RES RMOD(R) 30 50 5
```

The equivalent way to specify this in Xyce would be:

```
R1 1 2 RMOD 1
.model RMOD RES(R=30)
.step RMOD:R 30 50 5
```

Note that Xyce does not require the **RES** keyword on the **.STEP** line. In PSpice, this keyword is needed to specify what type of model is being used. Xyce actually has more flexibility than PSpice in this regard—any model or instance variable can be set on the **.STEP** line using the same syntax.

Example: `.step D101:IS 1.0e-3 5.0e-3 1.0e-3`

In this example, D101 is the name of a model or instance, and IS is the name of the parameter within that model or instance.

6.1.7. Behavioral Digital Devices

There are at least four significant differences. First, the instance line syntax for the Xyce digital behavioral devices differs from PSpice. Second, Xyce uses one model card for the timing and Input/Output (I/O) characteristics, while PSpice uses separate model cards for timing and I/O characteristics. The model cards also have different parameters. Third, Xyce does support the DIGINITSTATE option. However, it has a different default value than in PSpice. So, the DCOP calculations for flip-flops and latches may be different in some cases between Xyce and PSpice. Finally, closely spaced input transitions to a gate (e.g., ones spaced by less than the DELAY parameter of the Xyce model) may produce different behaviors in Xyce and PSpice. Please consult Section 2.3.28 for more details.

6.1.8. Power Dissipation

PSpice supports printing the power dissipation of a device via syntax like W(<name>). At this time, not all Xyce devices support power calculations. In addition, the Xyce results for the FET semiconductor devices (J, M and Z devices) may differ from the PSpice results. Consult the Features Supported by Xyce Device Models table in Section 2.3 and the individual sections on each device for more details. Additional limitations on lead current and power calculations in Xyce are given in Section 2.3.3.

Example work-arounds are as follows, using either the node voltage at Node 2 or the lead current through Resistor 2:

```
.DC V1 0 5 1
.param R2VAL=10
V1 1 0 5V
R1 1 2 10
R2 2 0 {R2VAL}
.PRINT DC V(2) {V(2)*V(2)/R2VAL} {I(R2)*I(R2)*R2VAL}
```

6.1.9. Dependent Sources with TABLE Syntax

The documented PSpice syntax for the TABLE form of the E and G sources is identical to the Xyce syntax for those two devices. As an example, consider this E-source netlist line which conforms to the documented PSpice and Xyce syntaxes:

```
E5 5 0 TABLE V(1,0) = (-2,-3) (2,3)
```

There is an equal sign between the expression {V(1,0)} and the list of value pairs (e.g., before (-2, -3)). There is also a comma between the two values in each set of value pairs. However, it has been observed that some PSpice versions will accept variants of the documented PSpice syntax. As examples, PSpice might use this TABLE syntax, where the equal sign between the expression and the list of value pairs is missing and there is an extra set of parentheses around the list of value pairs:

```
TABLE {EXPR} ((x1,y1) (x2,y2) ... (xn, yn))
```

PSpice might also specify the TABLE syntax without the commas between the two values in each set of value-pairs. For example, this is a legal syntax in some PSpice versions:

```
TABLE {EXPR} = (x1 y1) (x2 y2) ... (xn yn)
```

So, the generic solution is to change these alternative PSpice syntaxes (and possibly others) to conform with the Xyce E and G source TABLE syntax, which is (see also Sections 2.3.12 and 2.3.14):

```
TABLE {EXPR} = (x1,y1) (x2,y2) ... (xn, yn)
```

6.1.10. MODEL STATEMENTS

In PSpice, some .MODEL statements may have commas separating the list of parameters, which causes problems in Xyce. A simple workaround is to replace those commas with spaces in the corresponding Xyce .MODEL statements.

In PSpice, some .MODEL statements may not have parentheses surrounding the list of parameters. While Xyce also does not require parentheses in model cards, parentheses are accepted. The only Xyce requirement is that if they are used then they must be paired with one left parenthesis before all of the parameters and one right parentheses after all of the parameters. It is an error to have unmatched parentheses.

PSpice syntaxes where only a subset of the model parameters are enclosed within parentheses are also not supported in Xyce. A PSpice example is:

```
.model somebjt NPN Is=1e-16 (Xti=3 Bf=100) Eg=1.11 NC=2
```

Nested parentheses, as is often seen when a DEV (deviation) is specified for a parameter in a PSpice model statement, are also not allowed in Xyce. A PSpice example is:

```
.model someotherbjt NPN(Is=1e-16 Xti=3 (Bf=100 DEV=5%) Eg=1.11 NC=2)
```

The previous PSpice example also raises the issue of model parameters that are supported in PSpice but not in Xyce. In that case, Xyce will issue a warning about the invalid parameter and the simulation will run.

Another common issue is a PSpice model parameter (e.g., BV=) without a value. That PSpice syntax error is often silently ignored in PSpice, but flagged as a parsing error in a Xyce netlist.

Temperature coefficient (TC) specifications can be a problem also. The documented PSpice syntax is this, with a comma between the two values.

```
TC=0.1,0.1
```

However, it has been observed that some PSpice versions allow the TC parameter to omit the comma between those two values. That is not legal in Xyce.

6.1.11. .NODESET and .IC Statements

Xyce and PSpice differ in their capabilities to handle .NODESET and .IC statements in subcircuits. See sections 2.1.22 and 2.1.14 for more details.

6.1.12. Piecewise Linear Sources

The preferred Xyce syntax for PWL sources does not use parentheses or commas within the time-voltage pair listing. See Section 2.3.9 for more details.

The Xyce PWL source does not support the PSpice `.IN` format for file input. See Section 2.3.9 for the ASCII text and `.csv` formats supported by Xyce for file input.

The Xyce repeat `R=<value>` syntax for PWL sources is not compatible with the PSpice `REPEAT` syntax for PWL sources. Some work-arounds are as follows. This PSpice `REPEAT FOREVER` syntax:

```
VPWL1 1 0 PWL REPEAT FOREVER (0,0) (0.5,1) (1,0)
+ ENDREPEAT
```

is equivalent to this Xyce syntax:

```
VPWL1 1 0 PWL 0 0 0.5 1 1 0 R=0
```

Similarly, if the PSpice source has its time-voltage pairs in a `.csv` file, and the specified waveform starts at `time=0`, then this PSpice syntax:

```
VPWL2 2 0 PWL
+ REPEAT FOREVER
+ FILE "data.csv"
+ ENDREPEAT
```

is equivalent to this Xyce syntax:

```
VPWL2 2 0 PWL file "data.csv" R=0
```

For more general PSpice `REPEAT` syntaxes, and especially for the PSpice `REPEAT for N` syntax, the user might have to manually duplicate the PSpice waveform in a `.csv` file.

6.1.13. .AC Output

The Xyce `.csd` file format for a `.AC` analysis is different than the PSpice format, but is still viewable in the PSpice A/D waveform viewer. This PSpice `.PROBE` statement:

```
.PROBE/CSDF V([1b]) VR([1b]) VI([1b])
```

will produce `#N` and `#C` lines in its `netlistName.csd` file like this, where the real and imaginary parts of `V(1b)` are output for each data point on the `#C` line. The end-user can then use the PSpice A/D UI to choose to plot the `VR` and `VI` quantities.

```
#N
'V(1b)' 'V(1b)' 'V(1b)'
#C 1.000000000000E01 3
2.470E-02/-1.552E-01:1 2.470E-02/-1.552E-01:2 2.470E-02/-1.552E-01:3
```

This corresponding Xyce `.PRINT AC` statement:

```
.PRINT AC FORMAT=PROBE V(1b) VR(1b) VI(1b)
```

will produce #N and #C lines in its netlistName.csd file like this, where the real and imaginary parts of V(1b) are still output on the #C line. However, in Xyce, the VR() and VI() operators return real-valued quantities as shown below. This Xyce formatted file is still viewable in PSpice A/D.

```
#N
'V(1b)' 'VR(1b)' 'VI(1b)'
#C 1.000000000000E01 3
2.470e-02/-1.552e-01:1 2.470e-02/0.000e+00:2 -1.552e-01/0.000e+00:3
```

6.1.14. Additional differences

Some other differences between Xyce and PSpice are described in Table 6-1. Users should also consult Table 6-2, since that table lists more general incompatibilities that span multiple circuit simulators.

Table 6-1. Incompatibilities with PSpice.

Issue	Comment
<i>log()</i>	Xyce interprets <i>log()</i> in an expression as a base-10 <i>log()</i> while PSpice interprets <i>log()</i> as a natural <i>log()</i> function.
.VECTOR, .WATCH, and .PLOT output control analysis are not supported.	Xyce does not support these commands.
.PZ analysis is not supported.	Xyce does not support this command.
.DISTO analysis is not supported.	Xyce does not support this command.
.TF analysis is not supported.	Xyce does not support this command.
.AUTOCONVERGE is not supported.	Xyce does not support this command.
.SENS analysis is supported, but has a different syntax than PSpice.	The Xyce version of .SENS requires that the user specify exactly which parameters are the subject of the sensitivity analysis. Additionally, Xyce can compute sensitivities in transient and .AC as well as the .DC case (unlike PSpice).
.NOISE analysis is supported, but not all devices supported.	The Xyce version of .NOISE is new enough that not all noise models have been implemented.
.MC and .WCASE statistical analyses are not supported.	Xyce does not support these commands directly. However, Xyce does support a variety of UQ methods, including .SAMPLING, .EMBEDDEDSAMPLING and various polynomial chaos expansion methods.
.DISTRIBUTION, which defines a user distribution for tolerances, is not supported.	Xyce does not support this command. This command goes along with .MC and .WCASE statistical analyses, which are also not directly supported.
.LOADBIAS and .SAVEBIAS initial condition commands are not supported.	Xyce does not support these commands.
.ALIASES, .ENDALIASES, are not supported.	Xyce does not support these commands.
.STIMULUS is not supported.	Xyce does not support this command.
.TEXT is not supported.	Xyce does not support this command.
.PROBE does not work	Xyce does not support this. Use the FORMAT=PROBE option of .PRINT instead. See section 2.1.31 for syntax.

.OP only produces output in serial	.OP is supported in Xyce, but will not produce the extra output normally associated with the .OP statement, if running a parallel build.
Pulsed source rise time of zero	A requested pulsed source rise/fall time of zero really is zero in Xyce. In other simulators, requesting a zero rise/fall time causes them to use the printing interval found on the tran line.
Mutual Inductor Model	Not the same as PSpice. This is a Sandia developed model.
.PRINT line shorthand	Output variables have to be specified as a V(node) or I(source). Listing the node alone will not work.
BSIM3 level	In Xyce the BSIM3 level=9. In PSpice the BSIM3 is level=7.
Interactive mode	Xyce does not have an interactive mode.
Time integrator default tolerances	Xyce has much tighter default solver tolerances than some other simulators (e.g., PSpice), and thus often takes smaller time steps. As a result, it will often take a greater number of total time steps for a given time interval. To have Xyce take time steps comparable to those of PSpice, set the RELTOL and ABSTOL time integrator options to larger values (e.g., RELTOL=1.0E-2, ABSTOL=1.0E-6).
.OPTIONS statements	Xyce does not support PSpice style .OPTION statements. In Xyce, the various packages all (potentially) have their own separate .OPTIONS line in the netlist. For a complete description, see section 2.1.25.
DTMAX	Xyce does support a maximum time step-size control on the .tran line, but we discourage its use. The time integration algorithms within Xyce use adaptive time-stepping methods that adjust the time-step size according to the activity in the analysis. If the simulator is not providing enough accuracy, the RELTOL and ABSTOL parameters should be decreased for both the time integration package (.OPTIONS TIMEINT) and the transient nonlinear solver package (.OPTIONS NONLIN-TRAN). We have found that in most cases specifying the same maximum timestep that PSpice requires for convergence actually slows Xyce down by preventing it from taking larger timesteps when the behavior warrants.
.TRAN "UIC" keyword	PSpice requires the use of a keyword UIC on the .TRAN line in order to use initial conditions via IC keywords on instance lines. Doing so also tells PSpice not to perform an operating point calculation. In Xyce, UIC is ignored and produces a warning message. Xyce always uses initial conditions specified with IC keywords, and the case of inductors and capacitors automatically inserts a fictitious voltage source around the device that guarantees the correct potential drop across the device during the operating point. If the user desires that Xyce not perform an operating point calculation, but rather use an initial condition for a transient run of all zero voltages, then the user should specify NOOP instead.
Temperature specification	Device temperatures in Xyce are specified through the .OPTIONS DEVICE line. PSpice allows a .TEMP line that is not recognized (and is ignored) by Xyce.
Lead currents for lossless transmission lines	PSpice uses A and B to reference the two terminals of the lossless transmission line. So, Xyce uses I1() and I2(), while PSpice uses IA() and IB() to access the lead currents for the device.
Extended ASCII characters in .LIB files	The use of those characters is fine in Xyce comment lines. It may be best to replace them with the printable equivalent on other Xyce netlist lines though.

6.1.15. Translating Between PSpice and Xyce Netlists

Some internal Sandia users have found the following checklist to be helpful in getting their PSpice netlists to run in Xyce. Additional changes may be needed in some cases.

For the .cir file:

- Change .LIB references to point to the modified libraries generated for use with Xyce.
- Change PROBE and PROBE64 statements to PRINT <Sim Type>
- Find cases where the PSpice netlist used N() rather than V().
- .DC has the keyword PARAM in PSpice. If it exists then remove it in the Xyce netlist.
- .OPTIONS TNOM=X is changed to .OPTIONS DEVICE TNOM=X in the Xyce netlist.
- .TEMP args does not exist in Xyce. The equivalent Xyce statement is .STEP TEMP LIST args
- The default time integrator tolerances can make Xyce take smaller timesteps on some circuits, and therefore have slower simulation times. The Xyce timesteps can be increased at the expense of time integration accuracy by loosening the integrator tolerances. Some users find that .OPTIONS TIMEINT RELTOL=1e-2 ABSTOL=1e-4 leads to time steps more like PSpice's.
- Move any .IC and .NODESET statements to the top-level, and use the fully qualified node names in those statements.
- Adjust the syntax for any PWL sources, if needed, per Section 6.1.12.

For the .lib file:

- Add LEVEL=2 parameter to diode models.
- Fix the parentheses and comma differences between PSpice and Xyce .MODEL statements per Section 6.1.10.
- Find and modify any nested expression statements. This may entail replacing “{” with “(” in the expression in the Xyce netlist.
- Fix the table syntax for dependent sources, as discussed in Section 6.1.9.

6.2. Differences Between Xyce and Other SPICE Simulators

This section covers some known differences between Xyce and other SPICE-like circuit simulators, besides PSpice, as listed in Table 6-2. However, users of those other simulators (e.g., SPICE3F5, HSPICE, ngspice, ...) should also check the previous subsection on PSpice, since some of that discussion also applies here.

Table 6-2. Incompatibilities with Other Circuit Simulators.

Issue	Comment
.DC sweep output.	The .DC sweep calculation does not automatically output the sweep variable. Only variables explicitly listed on the .PRINT line are output.

MOSFET levels.	In Xyce the MOSFET levels are not the same. In Xyce, a BSIM3 is MOSFET level 9. Other simulators have different levels for the BSIM3.
BSIM SOI v3.2 level.	In Xyce the BSIM SOI (v3.2) is MOSFET level 10. Other simulators have different levels for the BSIM SOI.
BSIM4 level.	In Xyce the BSIM4 is MOSFET levels 14 and 54. Other simulators have different levels for the BSIM4.
Syntax for .STEP is different.	The manner of specifying a model parameter to be swept is slightly different than in some other simulators. See the Xyce Users' and Reference Guides for details.
Switch is not the same as SPICE3F5.	The Xyce switches are not compatible with the simple switch implementation in SPICE3F5. The switch in Xyce smoothly transitions between the ON and OFF resistances over a small range between the ON and OFF values of the control signal (voltage, current, or control expression). See the Xyce Reference Guide for the precise equations that are used to compute the switch resistance from the control signal values. The SPICE3F5 switch has a single switching threshold voltage or current, and RON is used above threshold while ROFF is used below threshold. Xyce's switch is considerably less likely to cause transient simulation failures. Results similar to SPICE3F5 can be obtained by setting VON and VOFF to the same threshold value, but this is not a recommended practice.
Piecewise Linear (PWL) source not fully compatible with either HSPICE or PSpice.	See Sections 2.3.9 and 6.1.12 of the Xyce Reference Guide for more details.
Acceptable prefixes in the metric system.	The "atto" prefix, which is designated by "a", is acceptable in HSPICE, but is not accepted in Xyce. The use of the "atto" prefix in Xyce must be replaced with "E-18".
Hierarchical parameters.	In Xyce hierarchical parameters, M (multiplier or multiplicity factor) and S (scale), are not commonly supported. The M parameter is only supported by the R, L, C and MOSFET device models and some BJT device models (VBIC 1.3 and MEXTRAM).
.MEASURE has some incompatibilities and differences with HSPICE.	See Section 2.1.18.14 of the Xyce Reference Guide for more details.
The P() accessor for power may give different results for semiconductor devices (D, J, M, Q and Z devices) and the lossless transmission device (T device) than with HSPICE.	See Sections 2.3.8, 2.3.18, 2.3.20, 2.3.17 2.3.25 and 2.3.19 for more details.
The Xyce .OP statement provides less output than other simulators.	See Section 2.1.24 for more details.
Initial conditions for lossless and lossy transmission lines	In SPICE3F5 and PSpice, initial conditions can be set on the initial voltages and currents at each end of the lossless transmission line, but not for the lossy transmission line. In Xyce, initial conditions can be set on the initial voltages and currents at each end of the lossy transmission line, but not for the lossless transmission line

Use of vgs(Mxxx) style syntax on the .PRINT line	Some SPICE-style circuit simulators can use the .PRINT line to (for example) print out the vds, vgb, vsd, etc. values for a PMOS transistor (say, M1) using .PRINT TRAN vgs(M1) vbs(M1) vds(M1). This is not directly supported in Xyce. See Section 2.3.17 for how this is supported with the N() syntax for the BSIM3 and BSIM4 models. For other transistor devices, use something like this on the Xyce .PRINT line, V(ng,ns) where ng and ns are the names of the circuits nodes attached to the gate and source terminals of the transistor.
Some devices do not work in frequency-domain analysis	Devices that may be expected to work in AC or HB analysis do not at this time. For AC analysis this includes, but is not limited to, the lossy transmission line (LTRA) and lossless transmission line (TRA). The LTRA and TRA models will need to be replaced with lumped transmission line models (YTRANSLINE) to perform small-signal AC analysis. For harmonic balance, the two transmission line models do work correctly in frequency domain. Independent behavioral sources, such as a time-dependent B, E, F, G, or H source, will not work correctly with either AC or HB. However, such sources which are purely dependent (only depending on solution variables and not time) will work in AC and HB.

6.3. DC Operating Point Calculation Failures in Xyce

This section discusses various netlist problems that can cause Xyce to fail to get a DC Operating Point (DCOP). Some of this discussion is “tutorial” in nature, but helps illustrate the issues.

6.3.1. Incompatible Voltage Constraints at Circuit Nodes

The Xyce DCOP calculation will fail if the netlist specifies incompatible voltage constraints at a given node in the circuit. This netlist fragment will cause Xyce to fail to get a DCOP because the two voltage sources obviously cannot both apply their assigned voltage at Node1.

```
VA Node1 0 1
VB Node1 0 2
```

This configuration is also not allowed because there is an infinite number of ways that the two voltage sources can supply current to the rest of the circuit and still maintain the requested voltage.

```
VA Node1 0 1
VB Node1 0 1
```

With those two netlist fragments as background, the next two examples illustrate a “Xyce-unique” way that DCOP failure can occur. This happens because initial conditions on capacitors in Xyce are enforced with additional voltage sources during the DCOP. So, these two netlist fragments are identical to the two cases given above, and will both cause a DCOP failure in Xyce. A similar problem can occur with other Xyce devices that allow initial conditions, for voltage drops across the device, to be set.

```
VA node1 0 1
CB node1 0 1.0pf IC=2
```

or

```
VA node1 0 1
CB node1 0 1.0pf IC=1
```

6.3.2. Multiple Voltage Constraints From Subcircuits or at Global Nodes

Similar incompatible voltage constraints can be caused by subcircuit definitions, if the subcircuits enforce voltage constraints on one (or more) of their interface nodes. An example netlist fragment is given below. In this example, subcircuits X1 and X2 are trying to enforce incompatible constraints at Node1 in the top-level circuit. This is notionally identical to the first example in the previous subsection. However, these incompatibilities can be harder to find if the subcircuit definitions are located in different library files.

```
X1 node1 0 MySubcircuitA
X2 node1 0 MySubcircuitB
.SUBCKT MYSUBCIRCUITA 1 2
VA 1 0 1
R1A 1 internalNodeA 0.5
R2A internalNodeA 2 0.5
.ENDS
.SUBCKT MYSUBCIRCUITB 3 4
VB 3 0 2
R1B 3 internalNodeB 0.5
R2B internalNodeB 4 0.5
.ENDS
```

Global nodes that have voltage sources applied to them from separate parts of the circuit (e.g, from within subcircuit definitions) can cause yet another version of the DCOP failure modes given in the previous subsection. If these two netlist statements are given in different subcircuit definitions then a Xyce DCOP failure will occur.

```
Vpin1 $G_GlobalNode1 0 1
Vpin2 $G_GlobalNode1 0 2
```

Of course, the examples given above can occur in varied combinations.

6.3.3. NODESET and IC Statements in Subcircuits

As previously noted, Xyce does not support .NODESET and .IC statements in subcircuits. This is a common cause of DCOP failure in Xyce when the same netlist converges in PSpice. See sections 2.1.22 and 2.1.14 for more details on how to move those .NODESET and .IC statements to the “top-level” in the Xyce netlist.

6.3.4. No DC Path to Ground for a Current Flow

A Xyce DCOP failure can occur if there is no DC path to ground at a node but a current flow must occur. This can happen because of a typographic error during netlist entry. An simple example is as follows, where the netlist line for R1 has 0 (“oh”) rather than 0 (“zero”). It can also happen when all of the current into a subcircuit must flow through capacitors.

```
I1 1 0 1
R1 1 0 1
C1 1 0 2pF
```

6.3.5. Inductor Loops

An inductor loop with no DC path to ground will also typically cause a DCOP failure. A simple example is:

```
V1 1 0 1
R1 1 2 1
L1 2 3 2uH
L2 2 3 2uH
R3 3 0 1
```

6.3.6. Infinite Slope Transitions

It is possible for a user to specify expressions that could have infinite-slope transitions with B-, E-, F-, G- and H-sources. A common example is IF statements within those source definitions. This can often lead to “timestep too small” errors when Xyce reaches the transition point. In some cases, it can also cause DCOP failures. See Section 2.3.16 and the “Analog Behavioral Modeling” (ABM) chapter of the Xyce Users’ Guide [1] for guidance on using the B-source device and ABM expressions. Those recommendations also apply to the E-, F-, G- and H-sources.

6.3.7. Simulation Settings

Automatic source stepping was added to Xyce in version 6.3. Xyce also automatically does Gmin stepping when the DCOP calculation fails to converge. In addition, the time integration options normally do not affect the DCOP calculation. So, adjusting the simulation settings for Xyce typically has no effect on the DCOP calculation. However, if both of the automatic homotopy methods mentioned above do not work, and none of the other netlist issues mentioned above exist, then Xyce does have other homotopy methods available. See the Xyce Users’ Guide [1] for more details.

This page intentionally left blank.

7. QUICK REFERENCE FOR MICROSOFT WINDOWS USERS

Xyce is supported on Microsoft Windows. However, the primary targets for Xyce are high-performance supercomputers and workstations, which are almost always running a variant of Unix. All of Xyce development is done on Unix platforms. Bearing this in mind, there are occasionally issues with using a Unix application on a Windows platform. Some of these issues are described in the table below.

Table 7-1. Issues for Microsoft Windows.

Issue	Comment
File names are case-sensitive	Xyce will expect library files, which are referenced in the netlist, to have exactly the same case as the actual filename. If not, Xyce will be unable to find the library file.
Windows endline characters are different from other OS's	The characters that mark the end of a line in Windows are a carriage return followed by a Line Feed (CR+LF). In Unix-like systems (including Linux and OS X), the character is simply a Line Feed (LF). Moving a file between the two systems does not usually cause issues, but users should be aware of the difference in case problems arise.
Xyce is unable to read proprietary file formats.	Programs such as Microsoft Word by default use file formats that Xyce cannot recognize. It is best not to use such programs to create netlists, unless netlists are saved as *.txt files. If you must use a Microsoft editor, it is better to use Microsoft Notepad. In general, the best solution is to use a Unix-style editor, such as Vi, Gvim, or Emacs.

This page intentionally left blank.

8. RAWFILE FORMAT

The rawfile format produced by Xyce closely follows SPICE3 conventions. Differences are noted in section 8.3. Details on the both the ASCII and binary formats are provided here for reference.

8.1. ASCII Format

The ASCII file format can be created using the `-a` flag on the command line. See Chapter 3 for more information.

The ASCII format standard dictates that the file consist of lines or sets of lines introduced by a keyword. The `Title` and `Date` lines should be the first in the file, and should occur only once. They are followed by the `Plotname`, `Flags`, `No. Variables`, and `No. Points` lines for each plot.

Listed next are sets of `Variables`, and `Values` lines. Let *numvars* be the number of variables (as specified in the `No. Variables` line), and *numpts* be the number of points (as shown on the `No. Points` line). After the `Variables` keyword there must be *numvars* declarations of outputs, and after the `Values` keyword, there must be *numpts* lines, each consisting of *numvars* values.

Finally, Xyce also allows for a `Version` line to be placed after the `No. Points` line for compatibility with various software programs.

See Table 8-1 for a summary of the above.

Table 8-1. Xyce ASCII rawfile format.

Issue	Comment
<code>Title:</code>	An arbitrary string describing the circuit.
<code>Date:</code>	A free-format date string.
<code>Plotname:</code>	A string describing the analysis type.
<code>Flags:</code>	A string describing the data type (<i>real</i> or <i>complex</i>).
<code>No. Variables:</code>	The number of variables.
<code>No. Points:</code>	The number of points.
<code>Version: (optional)</code>	The version of Xyce used to generate this output. By default the version is not output in the header. It can be output with the <code>.options outputoutputversioninrawfile=true</code> option.
<code>Variables:</code>	A newline followed by multiple lines, one for each variable, of the form <code>[tab] <index> [tab] <name> [tab] <type></code> .
<code>Values:</code>	A newline followed by multiple lines, for each point and variable, of the form <code>[tab] <value></code> with an integer index preceding each set of points. Complex values are output as <code>[tab] <real component>, <imaginary component></code> .

8.2. Binary Format

The binary format is similar to the ASCII format, except that strings are null terminated rather than newline terminated. In addition, all the values lines are stored in a binary format. The binary storage of real values as double precision floats is architecture specific.

See Table 8-2 for a summary of the binary table format.

Table 8-2. Xyce binary rawfile format.

Issue	Comment
Title:	An arbitrary string describing the circuit.
Date:	A free-format date string.
Plotname:	A string describing the analysis type.
Flags:	A string describing the data type (<i>real</i> or <i>complex</i>).
No. Variables:	The number of variables.
No. Points:	The number of points.
Version: (optional)	The version of Xyce used to generate this output. By default the version is not output in the header. It can be output with the <code>.options outputoutputversioninrawfile=true</code> option.
Variables:	A newline followed by multiple lines, one for each variable, of the form <code>[tab] <index> [tab] <name> [tab] <type></code> .
Binary:	Each real data point is stored contiguously in <code>sizeof(double)</code> byte blocks. Complex values are output as real and imaginary components in a block of size <code>2*sizeof(double)</code> byte blocks.

8.3. Special Notes

- Complex data points are only output under AC analysis.
- `Commands` and `Options` lines are not used.
- Binary header is formatted ASCII.
- Xyce can output an optional `Version` line in the header.

REFERENCES

- [1] Eric R. Keiter, Richard L. Schiek, Heidi K. Thornquist, Ting Mei, Jason C. Verley, Karthik V. Aadithya, Joshua D. Schickling, and Gary L. Hennigan. Xyce Parallel Electronic Simulator: Users' Guide, Version 7.9. Technical Report SAND2024-14135, Sandia National Laboratories, Albuquerque, NM, 2024.
- [2] Orcad PSpice User's Guide. Technical report, Orcad, Inc., 1998.
- [3] Armin W. Doerry. Catalog of window taper functions for sidelobe control. Technical Report SAND2017-4042, Sandia National Laboratories, Albuquerque, NM, 2017.
- [4] Alan V. Oppenheim and Ronald W. Schaffer. *Digital Signal Processing*. Prentice Hall, 1975.
- [5] HSPICE User's Guide. Technical report, Synopsys, Mountain View, California, 2008.
- [6] PSPICE A/D Reference Guide. Technical report, Cadence, San Jose, California, 2008.
- [7] Touchstone File Format Specification, Version 2.0. Technical report, Open IBIS Forum, 2009.
- [8] Hiroshi Akima. A new method of interpolation and smooth curve fitting based on local procedures. *J. ACM*, 17(4):589–602, October 1970.
- [9] Gisela Engeln-Müllges and Frank Uhlig. *Akima and Renner Subsplines*, pages 341–352. Springer Berlin Heidelberg, Berlin, Heidelberg, 1996.
- [10] Jean-Paul Berrut and Lloyd N. Trefethen. Barycentric lagrange interpolation. *SIAM Rev*, 46:501–517.
- [11] Arthur P. Mattuck. *Introduction to Analysis*. Prentice Hall, Inc., 1999.
- [12] H. K. Gummel and H. C. Poon. An integral charge control model of bipolar transistors. *Bell Sys. Techn. J.*, May-June:827–852, 1970.
- [13] Matthias Rudolph. Documentation of the fbh hbt model, 2005.
- [14] The SiGe group at Auburn University. Mextram web site, 2015.
- [15] T. A. Fjeldly, T. Ytterdal, and M. Shur. *Introduction to Device Modeling and Circuit Simulation*. Wiley InterScience, 1998.
- [16] A. S. Grove. *Physics and Technology of Semiconductor Devices*. John Wiley and Sons, Inc., 1967.
- [17] P. Antognetti and G. Massobrio. *Semiconductor Device Modeling with SPICE*. McGraw-Hill, 1988.
- [18] J.H. Huang, Z.H. Liu, M.C. Jeng, K. Hui, M. Chan, P.K. KO, and C. Hu. BSIM3 Manual. Technical report, Department of Electrical Engineering and Computer Science, University of California, Berkeley, CA 94720.
- [19] M. Bucher, C. Lallement, C. Enz, F. Theodoloz, and F. Krummenacher. The EPFL/EKV MOSFET Model Equations for Simulation Technical Report: Model Version 2.6. Technical report, Electronics Laboratories, Swiss Federal Institute of Technology (EPFL), Lausanne, Switzerland, September 1997.

- [20] H. Shichman and D. A. Hodges. Modeling and simulation of insulated-gate field-effect transistor switching circuits. *IEEE Journal of Solid-State Circuits*, SC-3:285, September 1968.
- [21] A. Vladimirescu and S. Lui. The Simulation of MOS Integrated Circuits using SPICE2. Technical Report Memorandum No. M80/7, February 1980.
- [22] B. J. Sheu, D. L. Scharfetter, P.-K. Ko, and M.-C. Jeng. BSIM: Berkeley Short-channel IGFET Model for MOS Transistors. *IEEE Journal of Solid-State Circuits*, SC-22:558–566, August 1987.
- [23] J. R. Pierret. A MOS Parameter Extraction Program for the BSIM Model. Technical Report Memorandum No. M84/99 and M84/100, November 1984.
- [24] Ping Yang, Berton Epler, and Pallab K. Chatterjee. An investigation of the charge conservation problem for MOSFET circuit simulation. *IEEE Journal of Solid-State Circuits*, SC-18(1), February 1983.
- [25] BSIM3v3.1 Manual. Technical report, Department of Electrical Engineering and Computer Science, University of California, Berkeley, CA 94720.
- [26] J. C. Bowers and H. A. Neinhaus. SPICE2 Computer Models for HEXFETs. Technical Report Application Note 954A, International Rectifier Corporation, Berkeley, CA 94720.
- [27] P. Su, H. Wan, S. Fung, M. Chan, A. Niknejad, and C. Hu. BSIM3SOI3.1 MOSFET MODEL Users' Manual. Technical report, Department of Electrical Engineering and Computer Science, University of California, Berkeley, CA 94720.
- [28] P. Su, H. Wan, S. Fung, M. Chan, A. Niknejad, and C. Hu. BSIM3SOI3.2 documentation. Technical report, Department of Electrical Engineering and Computer Science, University of California, Berkeley, CA 94720.
- [29] G. Gildenblat, X. Li, W.Wu, H. Wang, A. Jha, R. van Langevelde, G.D.J. Smit, A.J. Scholten, and D.B.M. Klaassen. PSP: An advanced surface-potential-based MOSFET model for circuit simulation. *IEEE Transactions on Electron Devices*, 53(9):1979–1993, 2006.
- [30] V. Sriramkumar, N. Paydavosi, J. Duarte, D. Lu, C. Lin, M. Dunga, S. Yao, T. Morshed, A. Niknejad, and C. Hu. BSIM-CMG 107.0.0 Multi-Gate MOSFET Compact Model Technical Manual. Technical report, Department of Electrical Engineering and Computer Science, University of California, Berkeley, CA 94720.
- [31] M. Bucher, A. Bazigos, E. Kitonaki, and F. Krummenacher. Recent advances in the EKV3 MOS transistor model. In *NANOTECH 2006, Workshop on Compact Models*, May 2006.
- [32] M. Bucher, D. Diamantakos, A. Bazigos, and F. Krummenacher. Design-oriented characterization and parameter extraction methodologies for the EKV3 MOSFET model. In *NANOTECH 2007 Workshop on Compact Modeling*, May 2007.
- [33] J.S. Roychowdhury, A.R. Newton, and D.O. Pederson. Algorithms for the transient simulation of lossy interconnect. *IEEE Trans. Computer-Aided Design of Integrated Circuits and Systems*, 13(1), 1994.
- [34] Tom Quarles. Spice3f5 Users' Guide. Technical report, University of California-Berkeley, Berkeley, California, 1994.
- [35] Abnita Munankarmay and Michael A. Heroux. A comparison of two equivalent real formulations for complex-valued linear systems part 1: Introduction and method. *American Journal of Undergraduate Research*, 1(3), 2002.

- [36] Federico Milano. *Power System Modelling and Scripting*. Springer, 2010.
- [37] Prabha Kundur. *Power System Stability and Control*. McGraw Hill, 1994.
- [38] Shahar Kvatinsky, Keren Talisveyberg, Dmitry Fliterand, Avinoam Kolodny, Uri C. Weiser, and Eby G. Friedman. Models of memristors for spice simulations. *IEEE 27th Convention of Electrical and Electronics Engineers in Israel*, pages 1–5, 2012.
- [39] Shahar Kvatinsky, Eby G. Friedman, Avinoam Kolodny, and Uri C. Weiser. Team: Threshold adaptive memristor model. *IEEE Transactions On Circuits And Systems—I*, 60:211–221, January 2013.
- [40] Shahar Kvatinsky, Eby G. Friedman, Avinoam Kolodny, and Uri C. Weiser. Generalized memristive device spice model and its application in circuit design. *IEEE Transactions on Computer-Aided Design of Integrated Circuits and Systems*, 32, August 2013.
- [41] Niroula J., Agarwal S., Jacobs-Gedrim R., Schiek R., Hughart D., Hsia A., James C., and Marinella M. Compact model of resistive memory for pulsed analog and neuromorphic applications. *Submitted to Journal of Computational Electronics*, 2017.
- [42] C. D. Thurmond. The standard thermodynamic function of the formation of electrons and holes in Ge, Si, GaAs, and GaP. *J. Electrochem. Soc.*, 122:1133, 1975.
- [43] D.M. Caughey and R.E. Thomas. Carrier mobilities in silicon empirically related to doping and field. *Proc. IEEE*, 55:2192–2193, 1967.
- [44] N.D. Arora, J.R. Hauser, and D.J. Roulston. Electron and hole mobilities in silicon as a function of concentration and temperature. *IEEE Transactions on Electron Devices*, ED-29:292–295, 1982.
- [45] J.M. Dorkel and Ph. Leturq. Carrier mobilities in silicon semi-empirically related to temperature, doping, and injection level. *Solid-State Electronics*, 24(9):821–825, 1981.
- [46] C. Lombardi, S. Manzini, A. Saporito, and M. Vanzi. A physically based mobility model for numerical simulation of nonplanar devices. *IEEE Transactions on Computer-Aided Design*, 7(11):1164–1170, November 1988.
- [47] Ben G. Streetman and Sanjay Banerjee. *Solid State Electronic Devices*. Prentice-Hall, Upper Saddle River, New Jersey, 2000.
- [48] K.E. Brenan, S.L. Campbell, and L.R. Petzold. *Numerical Solution of Initial-Value Problems in Differential-Algebraic Equations*. Society for Industrial and Applied Mathematics, Philadelphia, 1996.
- [49] Gary J. Templet, Richard L. Schiek, and Jason C. Verley. Xyce xdm netlist translator user guide, version 2.7. Technical Report SAND2023-07308, Sandia National Laboratories, 2022.

This page intentionally left blank.

APPENDIX A. Third Party Licenses

Xyce makes use of code developed by various third parties. The following text is provided to comply with the licenses of the codes that require it.

The ksparse solver in Xyce contains code derived from SPICE 3f5 source code:

Copyright (c) 1985-1991 The Regents of the University of California.
All rights reserved.

Permission is hereby granted, without written agreement and without license or royalty fees, to use, copy, modify, and distribute this software and its documentation for any purpose, provided that the above copyright notice and the following two paragraphs appear in all copies of this software.

IN NO EVENT SHALL THE UNIVERSITY OF CALIFORNIA BE LIABLE TO ANY PARTY FOR DIRECT, INDIRECT, SPECIAL, INCIDENTAL, OR CONSEQUENTIAL DAMAGES ARISING OUT OF THE USE OF THIS SOFTWARE AND ITS DOCUMENTATION, EVEN IF THE UNIVERSITY OF CALIFORNIA HAS BEEN ADVISED OF THE POSSIBILITY OF SUCH DAMAGE.

THE UNIVERSITY OF CALIFORNIA SPECIFICALLY DISCLAIMS ANY WARRANTIES, INCLUDING, BUT NOT LIMITED TO, THE IMPLIED WARRANTIES OF MERCHANTABILITY AND FITNESS FOR A PARTICULAR PURPOSE. THE SOFTWARE PROVIDED HEREUNDER IS ON AN "AS IS" BASIS, AND THE UNIVERSITY OF CALIFORNIA HAS NO OBLIGATION TO PROVIDE MAINTENANCE, SUPPORT, UPDATES, ENHANCEMENTS, OR MODIFICATIONS.

Xyce's linear solver makes use of the AMD library:

AMD, Copyright (c), 1996-2015, Timothy A. Davis,
Patrick R. Amestoy, and Iain S. Duff. All Rights Reserved.
Used in Xyce under the LGPL v2.1 license.

Parallel builds of Xyce use the Open MPI library:

Most files in this release are marked with the copyrights of the organizations who have edited them. The copyrights below are in no particular order and generally reflect members of the Open MPI core team who have contributed code to this release. The copyrights for code used under license from other parties are included in the corresponding files.

Copyright (c) 2004-2010 The Trustees of Indiana University and Indiana University Research and Technology Corporation. All rights reserved.

Copyright (c) 2004-2010 The University of Tennessee and The University of Tennessee Research Foundation. All rights reserved.

Copyright (c) 2004-2010 High Performance Computing Center Stuttgart, University of Stuttgart. All rights reserved.

Copyright (c) 2004-2008 The Regents of the University of California. All rights reserved.

Copyright (c) 2006-2010 Los Alamos National Security, LLC. All rights reserved.

Copyright (c) 2006-2010 Cisco Systems, Inc. All rights reserved.

Copyright (c) 2006-2010 Voltaire, Inc. All rights reserved.

Copyright (c) 2006-2011 Sandia National Laboratories. All rights reserved.

Copyright (c) 2006-2010 Sun Microsystems, Inc. All rights reserved. Use is subject to license terms.

Copyright (c) 2006-2010 The University of Houston. All rights reserved.

Copyright (c) 2006-2009 Myricom, Inc. All rights reserved.

Copyright (c) 2007-2008 UT-Battelle, LLC. All rights reserved.

Copyright (c) 2007-2010 IBM Corporation. All rights reserved.

Copyright (c) 1998-2005 Forschungszentrum Juelich, Juelich Supercomputing Centre, Federal Republic of Germany

Copyright (c) 2005-2008 ZIH, TU Dresden, Federal Republic of Germany

Copyright (c) 2007 Evergrid, Inc. All rights reserved.

Copyright (c) 2008 Chelsio, Inc. All rights reserved.

Copyright (c) 2008-2009 Institut National de Recherche en Informatique. All rights reserved.

Copyright (c) 2007 Lawrence Livermore National Security, LLC. All rights reserved.

Copyright (c) 2007-2009 Mellanox Technologies. All rights reserved.

Copyright (c) 2006-2010 QLogic Corporation. All rights reserved.

Copyright (c) 2008-2010 Oak Ridge National Labs. All rights reserved.

Copyright (c) 2006-2010 Oracle and/or its affiliates. All rights reserved.

Copyright (c) 2009 Bull SAS. All rights reserved.

Copyright (c) 2010 ARM ltd. All rights reserved.

Copyright (c) 2010-2011 Alex Brick <bricka@ccs.neu.edu>. All rights reserved.

Copyright (c) 2013-2014 Intel, Inc. All rights reserved.

Copyright (c) 2011-2014 NVIDIA Corporation. All rights reserved.

Additional copyrights may follow

Redistribution and use in source and binary forms, with or without modification, are permitted provided that the following conditions are met:

- Redistributions of source code must retain the above copyright notice, this list of conditions and the following disclaimer.
- Redistributions in binary form must reproduce the above copyright notice, this list of conditions and the following disclaimer listed in this license in the documentation and/or other materials provided with the distribution.
- Neither the name of the copyright holders nor the names of its contributors may be used to endorse or promote products derived from this software without specific prior written permission.

The copyright holders provide no reassurances that the source code provided does not infringe any patent, copyright, or any other intellectual property rights of third parties. The copyright holders disclaim any liability to any recipient for claims brought against recipient by any third party for infringement of that parties intellectual property rights.

THIS SOFTWARE IS PROVIDED BY THE COPYRIGHT HOLDERS AND CONTRIBUTORS "AS IS" AND ANY EXPRESS OR IMPLIED WARRANTIES, INCLUDING, BUT NOT LIMITED TO, THE IMPLIED WARRANTIES OF MERCHANTABILITY AND FITNESS FOR A PARTICULAR PURPOSE ARE DISCLAIMED. IN NO EVENT SHALL THE COPYRIGHT OWNER OR CONTRIBUTORS BE LIABLE FOR ANY DIRECT, INDIRECT, INCIDENTAL, SPECIAL, EXEMPLARY, OR CONSEQUENTIAL DAMAGES (INCLUDING, BUT NOT LIMITED TO, PROCUREMENT OF SUBSTITUTE GOODS OR SERVICES; LOSS OF USE, DATA, OR PROFITS; OR BUSINESS INTERRUPTION) HOWEVER CAUSED AND ON ANY THEORY OF LIABILITY, WHETHER IN CONTRACT, STRICT LIABILITY, OR TORT (INCLUDING NEGLIGENCE OR OTHERWISE) ARISING IN ANY WAY OUT OF THE USE OF THIS SOFTWARE, EVEN IF ADVISED OF THE POSSIBILITY OF SUCH DAMAGE.

Xyce uses the Trilinos Solver Framework:

Trilinos: An Object-Oriented Solver Framework
Copyright (2001) Sandia Corporation

Copyright (2001) Sandia Corporation. Under the terms of Contract DE-AC04-94AL85000, there is a non-exclusive license for use of this work by or on behalf of the U.S. Government. Export of this program may require a license from the United States Government.

1. Redistributions of source code must retain the above copyright notice, this list of conditions and the following disclaimer.

2. Redistributions in binary form must reproduce the above copyright notice, this list of conditions and the following disclaimer in the documentation and/or other materials provided with the distribution.

3. Neither the name of the Corporation nor the names of the contributors may be used to endorse or promote products derived from this software without specific prior written permission.

THIS SOFTWARE IS PROVIDED BY SANDIA CORPORATION "AS IS" AND ANY EXPRESS OR IMPLIED WARRANTIES, INCLUDING, BUT NOT LIMITED TO, THE IMPLIED WARRANTIES OF MERCHANTABILITY AND FITNESS FOR A PARTICULAR PURPOSE ARE DISCLAIMED. IN NO EVENT SHALL SANDIA CORPORATION OR THE CONTRIBUTORS BE LIABLE FOR ANY DIRECT, INDIRECT, INCIDENTAL, SPECIAL, EXEMPLARY, OR CONSEQUENTIAL DAMAGES (INCLUDING, BUT NOT LIMITED TO, PROCUREMENT OF SUBSTITUTE GOODS OR SERVICES; LOSS OF USE, DATA, OR PROFITS; OR BUSINESS INTERRUPTION) HOWEVER CAUSED AND ON ANY THEORY OF LIABILITY, WHETHER IN CONTRACT, STRICT LIABILITY, OR TORT (INCLUDING NEGLIGENCE OR OTHERWISE) ARISING IN ANY WAY OUT OF THE USE OF THIS SOFTWARE, EVEN IF ADVISED OF THE POSSIBILITY OF SUCH DAMAGE.

NOTICE: The United States Government is granted for itself and others acting on its behalf a paid-up, nonexclusive, irrevocable worldwide license in this data to reproduce, prepare derivative works, and perform publicly and display publicly. Beginning five (5) years from July 25, 2001, the United States Government is granted for itself and others acting on its behalf a paid-up, nonexclusive, irrevocable worldwide license in this data to reproduce, prepare derivative works, distribute copies to the public, perform publicly and display publicly, and to permit others to do so.

NEITHER THE UNITED STATES GOVERNMENT, NOR THE UNITED STATES DEPARTMENT OF ENERGY, NOR SANDIA CORPORATION, NOR ANY OF THEIR EMPLOYEES, MAKES ANY WARRANTY, EXPRESS OR IMPLIED, OR ASSUMES ANY LEGAL LIABILITY OR RESPONSIBILITY FOR THE ACCURACY, COMPLETENESS, OR USEFULNESS OF ANY INFORMATION, APPARATUS, PRODUCT, OR PROCESS DISCLOSED, OR REPRESENTS THAT ITS USE WOULD NOT INFRINGE PRIVATELY OWNED RIGHTS.

Some versions of Xyce use the Intel Math Kernel Library:

Intel Simplified Software License (Version April 2018)

Copyright (c) 2018 Intel Corporation.

Use and Redistribution. You may use and redistribute the software (the "Software"), without modification, provided the following conditions are met:

- * Redistributions must reproduce the above copyright notice and the following terms of use in the Software and in the documentation and/or other materials provided with the distribution.
- * Neither the name of Intel nor the names of its suppliers may be used to endorse or promote products derived from this Software without specific prior written permission.
- * No reverse engineering, decompilation, or disassembly of this Software is permitted.

Limited patent license. Intel grants you a world-wide, royalty-free, non-exclusive license under patents it now or hereafter owns or controls to make, have made, use, import, offer to sell and sell ("Utilize") this Software, but solely to the extent that any such patent is necessary to Utilize the Software alone. The patent license shall not apply to any combinations which include this software. No hardware per se is licensed hereunder.

Third party and other Intel programs. "Third Party Programs" are the files listed in the "third-party-programs.txt" text file that is included with the Software and may include Intel programs under separate license terms. Third Party Programs, even if included with the distribution of the Materials, are governed by separate license terms and those license terms solely govern your use of those programs.

DISCLAIMER. THIS SOFTWARE IS PROVIDED "AS IS" AND ANY EXPRESS OR IMPLIED WARRANTIES, INCLUDING, BUT NOT LIMITED TO, THE IMPLIED WARRANTIES OF MERCHANTABILITY, FITNESS FOR A PARTICULAR PURPOSE, AND NON-INFRINGEMENT ARE DISCLAIMED. THIS SOFTWARE IS NOT INTENDED FOR USE IN SYSTEMS OR APPLICATIONS WHERE FAILURE OF THE SOFTWARE MAY CAUSE PERSONAL INJURY OR DEATH AND YOU AGREE THAT YOU ARE FULLY RESPONSIBLE FOR ANY CLAIMS, COSTS, DAMAGES, EXPENSES, AND ATTORNEYS' FEES ARISING OUT OF ANY SUCH USE, EVEN IF ANY CLAIM ALLEGES THAT INTEL WAS NEGLIGENT REGARDING THE DESIGN OR MANUFACTURE OF THE MATERIALS.

LIMITATION OF LIABILITY. IN NO EVENT WILL INTEL BE LIABLE FOR ANY DIRECT, INDIRECT, INCIDENTAL, SPECIAL, EXEMPLARY, OR CONSEQUENTIAL DAMAGES (INCLUDING, BUT NOT LIMITED TO, PROCUREMENT OF SUBSTITUTE GOODS OR SERVICES; LOSS OF USE, DATA, OR PROFITS; OR BUSINESS INTERRUPTION) HOWEVER CAUSED AND ON ANY THEORY OF LIABILITY, WHETHER IN CONTRACT, STRICT LIABILITY, OR TORT (INCLUDING NEGLIGENCE OR OTHERWISE) ARISING IN ANY WAY OUT OF THE USE OF THIS SOFTWARE, EVEN IF ADVISED OF THE POSSIBILITY OF SUCH DAMAGE. YOU AGREE TO INDEMNIFY AND HOLD INTEL HARMLESS AGAINST ANY CLAIMS AND EXPENSES RESULTING FROM YOUR USE OR UNAUTHORIZED USE OF THE SOFTWARE.

No support. Intel may make changes to the Software, at any time without notice, and is not obligated to support, update or provide training for the Software.

Termination. Intel may terminate your right to use the Software in the event of your breach of this Agreement and you fail to cure the breach within a reasonable period of time.

Feedback. Should you provide Intel with comments, modifications, corrections, enhancements or other input ("Feedback") related to the Software Intel will be free to use, disclose, reproduce, license or otherwise distribute or exploit the Feedback in its sole discretion without any obligations or restrictions of any kind, including without limitation, intellectual property rights or licensing obligations.

Compliance with laws. You agree to comply with all relevant laws and regulations governing your use, transfer, import or export (or prohibition thereof) of the Software.

Governing law. All disputes will be governed by the laws of the United States of America and the State of Delaware without reference to conflict of law principles and subject to the exclusive jurisdiction of the state or federal courts sitting in the State of Delaware, and each party agrees that it submits to the personal jurisdiction and venue of those courts and waives any objections. The United Nations Convention on Contracts for the International Sale of Goods (1980) is specifically excluded and will not apply to the Software.

Xyce's implementation of the Diode-CMC model, version 2.0.0, is derived from Verilog-A sources provided under the following license:

Silicon Integration Initiative (Si2)
Compact Model Coalition In-Code Statement

Software is distributed as is, completely without warranty or service support. NXP Semiconductors, Hiroshima University, and Silicon Integration Initiative, Inc. (Si2), along with their employees are not liable for the condition or performance of the software.

NXP Semiconductors, Hiroshima University, and Si2 own the copyright and grant users a perpetual, irrevocable, worldwide, non-exclusive, royalty-free license with respect to the software as set forth below.

NXP Semiconductors, Hiroshima University, and Si2 hereby disclaim all implied warranties.

NXP Semiconductors, Hiroshima University, and Si2 grant the users the right to modify, copy, and redistribute the software and

documentation, both within the user's organization and externally, subject to the following restrictions

1. The users agree not to charge for the NXP Semiconductors, Hiroshima University, and Si2 -developed code itself but may charge for additions, extensions, or support.
2. In any product based on the software, the users agree to acknowledge NXP Semiconductors, Hiroshima University, and Si2 that developed the software. This acknowledgment shall appear in the product documentation.
3. Redistributions to others of source code and documentation must retain the copyright notice, disclaimer, and list of conditions.
4. Redistributions to others in binary form must reproduce the copyright notice, disclaimer, and list of conditions in the documentation and/or other materials provided with the distribution.

Xyce's implementations of the L-UTSOI and EKV 2.6 models are derived from Verilog-A sources provided under the ECL-2.0 license. The L-UTSOI is Copyright 2020 CEA-Leti.

The ECL-2.0 license text is as follows:

Licensed under Educational Community License, Version 2.0 (the "License"); you may not use this file except in compliance with the License. You may obtain a copy of the license at

<http://opensource.org/licenses/ECL-2.0>

Unless required by applicable law or agreed to in writing, software distributed under the License is distributed on an "AS IS" BASIS, WITHOUT WARRANTIES OR CONDITIONS OF ANY KIND, either express or implied. See the License for the specific language governing permissions and limitations under the License.

Xyce's implementation of the MEXTRAM model, version 504.12.1, is derived from Verilog-A sources provided under the following license:

Copyright (c) 2000-2007, NXP Semiconductors
Copyright (c) 2007-2014, Delft University of Technology
Copyright (c) 2015, Auburn University

INTELLECTUAL PROPERTY NOTICE, DISCLAIMER AND LICENSE

The Mextram model and documentation presented at this website, denoted as the Model, has been developed by NXP Semiconductors until 2007, Delft University of Technology from 2007 to 2014, and Auburn

University since April 2015.

The Model is distributed as is, completely without any expressed or implied warranty or service support. NXP Semiconductors, Delft University of Technology, Auburn University and their employees are not liable for the condition or performance of the Model.

NXP Semiconductors, Delft University of Technology, Auburn University own the copyright and grant users a perpetual, irrevocable, worldwide, non-exclusive, royalty-free license with respect to the Model as set forth below.

NXP Semiconductors, Delft University of Technology, Auburn University hereby disclaim all implied warranties.

NXP Semiconductors, Delft University of Technology, Auburn University grant the users the right to modify, copy, and redistribute the Model and documentation, both within the user's organization and externally, subject to the following restrictions

1. The users agree not to charge for the code itself but may charge for additions, extensions, or support.
2. In any product based on the Model, the users agree to acknowledge NXP Semiconductors, Delft University of Technology, Auburn University that developed the Model. This acknowledgment shall appear in the product documentation.
3. The users agree to obey all restrictions governing redistribution or export of the Model.
4. The users agree to reproduce any copyright notice which appears on the Model on any copy or modification of such made available to others.

Xyce's implementation of the HICUM/L0 model, version 1.32, is derived from Verilog-A sources provided under the following license:

Software is distributed as is, completely without warranty or service support. Michael Schroter and his team members are not liable for the condition or performance of the software.

Michael Schroter owns the copyright and grants users a perpetual, irrevocable, worldwide, non-exclusive, royalty-free license with respect to the software as set forth below.

Michael Schroter hereby disclaims all implied warranties.

Michael Schroter grants the users the right to modify, copy, and redistribute the software and documentation, both within the user's organization and externally, subject to the following restrictions.

1. The users agree not to charge for the model owner's code itself but may charge for additions, extensions, or support.
2. In any product based on the software, the users agree to acknowledge Michael Schroter who developed the model and software. This acknowledgment shall appear in the product documentation.
3. Redistributions to others of source code and documentation must retain the copyright notice, disclaimer, and list of conditions.
4. Redistributions to others in binary form must reproduce the copyright notice, disclaimer, and list of conditions in the documentation and/or other materials provided with the distribution

Xyce's implementation of the HICUM/L2 model, version 2.34, is derived from Verilog-A sources provided under the following license:

The Software is distributed as is, completely without expressed or implied warranty or service support. Michael Schroter and his team members are not liable for the condition or performance of the software.

Michael Schroter owns the copyright and grants users a perpetual, irrevocable, worldwide, non-exclusive, royalty-free license with respect to the software as set forth below.

Michael Schroter hereby disclaims all implied warranties.

Michael Schroter grants the users the right to modify, copy, and redistribute the software and documentation, both within the user's organization and externally, subject to the following restrictions.

1. The users agree not to charge for the model owner code itself but may charge for additions, extensions, or support.
2. In any product based on the software, the users agree to acknowledge Michael Schroter that developed the model and software. This acknowledgment shall appear in the product documentation.
3. Users agree to obey all government restrictions governing redistribution or export of the software.
4. The Users agree to reproduce any copyright notice which appears on the software and documentation on any copy or modification of such

made available to others.

Xyce's implementations of the BSIM3 v.3.2.2, the BSIM4 v. 4.6.1, the BSIM4 v. 4.7.0, and the BSIM-SOI v. 3.2, are based on the original code of those devices provided by University of California, Berkeley. They all have the following license:

Software is distributed as is, completely without warranty or service support. The University of California and its employees are not liable for the condition or performance of the software.

The University owns the copyright but shall not be liable for any infringement of copyright or other proprietary rights brought by third parties against the users of the software.

The University of California hereby disclaims all implied warranties.

The University of California grants the users the right to modify, copy, and redistribute the software and documentation, both within the user's organization and externally, subject to the following restrictions

1. The users agree not to charge for the University of California code itself but may charge for additions, extensions, or support.
2. In any product based on the software, the users agree to acknowledge the UC Berkeley BSIM Research Group that developed the software. This acknowledgment shall appear in the product documentation.
3. The users agree to obey all U.S. Government restrictions governing redistribution or export of the software.
4. The users agree to reproduce any copyright notice which appears on the software on any copy or modification of such made available to others.

Version 4.8.2 of the BSIM4 is licensed under the Educational Community License, Version 2.0:

Copyright 2020 University of California

Licensed under Educational Community License, Version 2.0 (the "License"); you may not use this file except in compliance with the License. You may obtain a copy of the license at

<http://opensource.org/licenses/ECL-2.0>

Unless required by applicable law or agreed to in writing, software

distributed under the License is distributed on an "AS IS" BASIS, WITHOUT WARRANTIES OR CONDITIONS OF ANY KIND, either express or implied. See the License for the specific language governing permissions and limitations under the License.

Xyce's implementation of the BSIM6 model, version 6.1.1, is derived from Verilog-A sources provided under the following license:

Software is distributed as is, completely without warranty or service support. The University of California and its employees are not liable for the condition or performance of the software.

The University owns the copyright but shall not be liable for any infringement of copyright or other proprietary rights brought by third parties against the users of the software.

The University of California hereby disclaims all implied warranties.

The University of California grants the users the right to modify, copy, and redistribute the software and documentation, both within the user's organization and externally, subject to the following restrictions

1. The users agree not to charge for the University of California code itself but may charge for additions, extensions, or support.
2. In any product based on the software, the users agree to acknowledge the UC Berkeley BSIM Research Group that developed the software. This acknowledgment shall appear in the product documentation.
3. The users agree to obey all U.S. Government restrictions governing redistribution or export of the software.
4. The users agree to reproduce any copyright notice which appears on the software on any copy or modification of such made available to others.

Xyce's implementations of the BSIM-SOI model, versions 4.5 and 4.6.1, are derived from Verilog-A sources provided under the following license:

The Regents of the University of California and Analog Devices, Inc. ("Authors") own the copyright but shall not be liable for any infringement of copyright or other proprietary rights brought by third parties against the users of the software.

The Authors jointly grant the users the right to modify, copy, and

redistribute the software and documentation, both within the user's organization and externally, subject to the following conditions:

1. The users agree not to charge for the original source code itself but may charge for additions, extensions, or support.
2. In any product based on the software, the users agree to acknowledge the UC Berkeley BSIM Research Group that developed the software. This acknowledgment shall appear in the product documentation.
3. The users agree to obey all U.S. Government restrictions governing redistribution or export of the software.
4. Redistributions of source code must retain the above copyright notices, this list of conditions and the following disclaimer.
5. Redistributions in binary form must reproduce the above copyright notices, this list of conditions and the following disclaimer in the documentation and/or other materials provided with the distribution.
6. Users may not claim authorship of the original software. Modified versions of the software must be plainly marked as such.
7. Users may not suggest any sponsorship or endorsement by the Authors of users' product.

THIS SOFTWARE IS PROVIDED BY AUTHORS AS IS AND ANY EXPRESS OR IMPLIED WARRANTIES, INCLUDING, BUT NOT LIMITED TO, THE IMPLIED WARRANTIES OF MERCHANTABILITY AND FITNESS FOR A PARTICULAR PURPOSE, AND NONINFRINGEMENT OF THIRD PARTY RIGHTS ARE DISCLAIMED. IN NO EVENT SHALL THE AUTHORS BE LIABLE FOR ANY DIRECT, INDIRECT, INCIDENTAL, SPECIAL, EXEMPLARY, OR CONSEQUENTIAL DAMAGES (INCLUDING, BUT NOT LIMITED TO, PROCUREMENT OF SUBSTITUTE GOODS OR SERVICES; LOSS OF USE, DATA, OR PROFITS; OR BUSINESS INTERRUPTION) HOWEVER CAUSED AND ON ANY THEORY OF LIABILITY, WHETHER IN CONTRACT, STRICT LIABILITY, OR TORT (INCLUDING NEGLIGENCE OR OTHERWISE) ARISING IN ANY WAY OUT OF THE USE OF THIS SOFTWARE, EVEN IF ADVISED OF THE POSSIBILITY OF SUCH DAMAGE.

Xyce's implementations of the BSIM-CMG model, versions 107.0.0 and 110.0.0, are derived from Verilog-A sources provided under the following license:

Software is distributed as is, completely without warranty or service support. The University of California and its employees are not liable for the condition or performance of the software.

The University owns the copyright but shall not be liable for any infringement of copyright or other proprietary rights brought by third

parties against the users of the software.

The University of California hereby disclaims all implied warranties.

The University of California grants the users the right to modify, copy, and redistribute the software and documentation, both within the user's organization and externally, subject to the following restrictions

1. The users agree not to charge for the University of California code itself but may charge for additions, extensions, or support.
2. In any product based on the software, the users agree to acknowledge the UC Berkeley BSIM Research Group that developed the software. This acknowledgment shall appear in the product documentation.
3. The users agree to obey all U.S. Government restrictions governing redistribution or export of the software.
4. The users agree to reproduce any copyright notice which appears on the software on any copy or modification of such made available to others.

Xyce's implementation of the MVS model, version 2.0.0, is derived from Verilog-A sources provided under the following license:

Copyright © 2013 Massachusetts Institute of Technology (MIT)

The terms under which the software and associated documentation (the Software) is provided are as the following:

The Software is provided "as is", without warranty of any kind, express or implied, including but not limited to the warranties of merchantability, fitness for a particular purpose and noninfringement. In no event shall the authors or copyright holders be liable for any claim, damages or other liability, whether in an action of contract, tort or otherwise, arising from, out of or in connection with the Software or the use or other dealings in the Software.

MIT grants, free of charge, to any users the right to modify, copy, and redistribute the Software, both within the user's organization and externally, subject to the following restrictions:

1. The users agree not to charge for the MIT code itself but may charge for additions, extensions, or support.
2. In any product based on the Software, the users agree to

acknowledge the MIT VS Model Research Group that developed the software. This acknowledgment shall appear in the product documentation.

3. The users agree to obey all U.S. Government restrictions governing redistribution or export of the software.
4. The users agree to reproduce any copyright notice which appears on the software on any copy or modification of such made available to others.

Xyce's implementation of the PSP model, version 102.5.0, is derived from Verilog-A sources provided under the following license:

INTELLECTUAL PROPERTY NOTICE, DISCLAIMER AND LICENSE

The compact model software and documentation presented at this website form a whole that will henceforth be denoted as the "Model".

The Model presented at this website has been co-developed by NXP Semiconductors and Arizona State University until and including 2011. For this part of the Model, NXP Semiconductors claims undivided ownership and copyrights.

Since 2012 until today the Model has been co-developed by NXP Semiconductors and Delft University of Technology and for this part each claim undivided ownership and copyrights.

DISCLAIMER

The owners are fully free to further develop, adapt and extend the Model as they judge necessary or desirable.

The Model is distributed as is, completely without any express or implied warranty, or service support. The owners and their employees are not liable in any way for the condition or performance of the Model. The owners hereby disclaim all implied warranties.

LICENSE

NXP Semiconductors and Delft University of Technology hereby grant users a perpetual, irrevocable, worldwide, non-exclusive, royalty-free license with respect to Versions of the Model which have been released through this website <http://psp.ewi.tudelft.nl>.

NXP Semiconductors and Delft University of Technology grant the users the right to modify, copy and redistribute the Model, both within the user's organization and externally, subject to the following restrictions.

RESTRICTIONS

1. The users agree not to charge for the Model itself but may charge for additions, extensions, or support.
2. In any product based on the Model, the users agree to acknowledge the owners as developers of the Model. This acknowledgment shall appear in the product documentation.
3. The users agree to only use the name of CMC standard models to identify implementations of the CMC standard models which produce the same outputs as Standard code for the same inputs passing all CMC QA tests.
4. The users agree to obey all government restrictions governing redistribution or export of the software.
5. The users agree to reproduce any copyright notice which appears on the software and documentation on any copy or modification of such made available to others.

Xyce's implementations of the PSP model, version 103.4.0, and the JUNCAP diode, are derived from Verilog-A sources provided under the following license:

Software is distributed as is, completely without warranty or service support. The Commissariat a l'energie atomique et aux energies alternatives (CEA), NXP Semiconductors, and Delft University of Technology, along with their employees are not liable for the condition or performance of the software.

NXP Semiconductors, Delft University of Technology, and CEA own the copyright and grant users a perpetual, irrevocable, worldwide, non-exclusive, royalty-free license with respect to the software as set forth below.

NXP Semiconductors, Delft University of Technology, and CEA hereby disclaim all implied warranties.

NXP Semiconductors, Delft University of Technology, and CEA grant the users the right to modify, copy, and redistribute the software and documentation, both within the user's organization and externally, subject to the following restrictions:

1. The users agree not to charge for the NXP Semiconductors, Delft University of Technology, and CEA-developed code itself but may charge for additions, extensions, or support.
2. In any product based on the software, the users agree to acknowledge NXP Semiconductors, Delft University of Technology, and CEA that developed the software. This acknowledgment shall appear in the product documentation.
3. Redistributions to others of source code and documentation must retain the copyright notice, disclaimer, and list of conditions.
4. Redistributions to others in binary form must reproduce the copyright notice, disclaimer, and list of conditions in the documentation and/or other materials provided with the distribution.

Xyce's implementation of the EKV 3.0 model is derived from Verilog-A sources developed by the EKV Team of the Electronics Laboratory-TUC (Technical University of Crete). They are included in Xyce under license from Technical University of Crete. The official web site of the EKV model is <http://ekv.epfl.ch/>.

Due to licensing restrictions, the EKV MOSFETs are not available in open-source versions of Xyce. The license for EKV3 authorizes Sandia National Laboratories to distribute EKV3 only in binary versions of the code.

Index

- Xyce
 - ABSTOL, 841
 - RELTOL, 841
 - convergence, 841
- .AC, 24
- .DCVOLT, 29, 48
- .EMBEDEDSAMPLING, 30
- .FFT, 35
- .FOUR, 40
- .FUNC, 42
 - allowed names, 43
 - subcircuit scoping, 42, 160
- .GLOBAL_PARAM, 45
- .GLOBAL, 44
- .HB, 47
- .IC, 48
- .INC, 49
- .LIB, 50
- .LIN, 52
- .MEASURE FFT, 84
- .MEASURE continuous, 78
- .MEASURE, 54, 58
- .MODEL, 177
 - subcircuit scoping, 89, 160
- .NODESET, 92
- .NOISE, 93
- .OPTIONS, 96, 844, 850
 - DEVICE, 97
 - DIAGNOSTIC, 99
 - DIST, 116
 - EMBEDEDSAMPLES, 113
 - FFT, 117
 - HBINT, 116
 - LINSOL-AC, 109
 - LINSOL-HB, 109
 - LINSOL, 106
 - LOCA, 105
 - MEASURE, 118
 - NONLIN-TRAN, 103
 - NONLIN, 103
 - OUTPUT, 110
 - PARSER, 119
 - PCES, 114
 - RESTART, 111
 - SAMPLES, 113
 - SENSITIVITY, 115
 - TIMEINT, 99
- .OP, 95
- .PARAM, 42, 120
 - subcircuit scoping, 121, 160
- .PCE, 122
- .PREPROCESS
 - ADDRESISTORS, 127
 - REMOVEUNUSED, 126
 - REPLACEGROUND, 125
- .PRINT, 25, 27, 47, 94, 128, 162
 - AC, 25, 136
 - DC, 27, 137
 - ES, 143
 - HB, 47, 137
 - NOISE, 94, 139
 - PCE, 143
 - TRAN, 140, 162
 - AC Analysis, 136
 - DC Analysis, 137
 - Device Parameters and Internal Variables, 147
 - EMBEDEDSAMPLING Analysis, 143
 - Harmonic Balance Analysis, 137
 - Homotopy Analysis, 141
 - Noise Analysis, 139
 - Parameter Stepping, 144
 - PCE Analysis, 143
 - Transient Analysis, 140
 - Wildcards, 146
- .RESULT, 149
- .SAMPLING, 150
- .SAVE, 152
- .SENS, 153
- .STEP, 155

- .SUBCKT, 159, 177
- .TRAN, 110, 161
- ABSTOL, 100, 104
- BPENABLE, 102
- DATA, 26
- DC, 27
- EXITSTEP, 103
- EXITTIME, 103
- MAXSTEP, 104
- NLNEARCONV, 100
- NLSMALLUPDATE, 100
- RELTOL, 100, 104
- RESTARTSTEPSCALE, 100
- 1d pde (level 1)
 - device instance parameters, 807
- 2d pde (level 2)
 - device instance parameters, 811
- AC analysis, 24
- accelerated mass device, 788
- Accelerated Mass Devices, 178
- algorithm
 - time integration, 850
- analog behavioral modeling
 - POLY, 174
 - polynomial expression, 174
- analysis
 - AC, 24
 - control parameters, 96
 - DC, 27, 103
 - Data Sweeps, 28, 157
 - Decade sweeps, 27
 - Linear sweeps, 27
 - List Sweeps, 28
 - Octave sweeps, 28
 - EMBEDDEDSAMPLING, 30
 - HB, 47
 - LHS, 30, 150
 - MC, 30, 150
 - Monte Carlo, 30, 150
 - Noise, 93
 - op, 95
 - options, 96
 - PCE, 30, 122, 150
 - pce, 122
 - SAMPLING, 30, 150
 - sampling, 30, 150
 - STEP
 - Decade sweeps, 157
 - Linear sweeps, 155
 - List sweeps, 157
 - Octave sweeps, 157
 - step, 155
 - transient, 103, 161, 162
- Aztec, 106, 109
- behavioral digital
 - device instance parameters, 779, 784
 - device model parameters, 779, 784
- bias point, 162
- bipolar junction transistor
 - device instance parameters, 247
 - device model parameters, 247
- BJT, 241
- BJT level 230
 - device output variables, 265
- BJT level 234
 - device output variables, 271
- BJT level 504
 - device output variables, 276
- BJT level 505
 - device output variables, 283
- bsim-cmg finfet v107.0.0
 - device instance parameters, 663
 - device model parameters, 664
- bsim-cmg finfet v108.0.0
 - device instance parameters, 693
 - device model parameters, 694
- bsim-cmg finfet v110.0.0
 - device instance parameters, 627
 - device model parameters, 628
- bsim-cmg finfet v111.2.1
 - device instance parameters, 566
 - device model parameters, 567
- bsim-soi 4.5.0
 - device instance parameters, 415
 - device model parameters, 416
- bsim-soi 4.6.1
 - device instance parameters, 384
 - device model parameters, 385
- bsim3
 - device instance parameters, 314
 - device model parameters, 314
- bsim3 soi
 - device instance parameters, 328
 - device model parameters, 329

- bsim4
 - device instance parameters, 350
 - device model parameters, 352
- bsim6
 - device instance parameters, 445
 - device model parameters, 446
- bsource, 238
- capacitor, 186
 - device instance parameters, 187
 - device model parameters, 188
- checkpoint, 111
- command line, 835
 - arguments, 835
- constants (EXP,PI), 42, 120
- controlled switch, 765
 - device model parameters, 767
- convergence, 841
- current controlled current source, 234
- current controlled voltage source, 237
- current source
 - current controlled, 234
 - independent, 221
 - nonlinear dependent, 238
 - voltage controlled, 235
- DC analysis, 27, 103
 - Data sweeps, 28, 157
 - Decade sweeps, 27
 - Linear sweeps, 27
 - List sweeps, 28
 - Octave sweeps, 28
- delay element
 - device instance parameters, 777
- device
 - ABM device
 - PSpice equivalent, 845
 - ACC Devices, 178
 - accelerated mass devices, 178
 - analog, 177
 - analog device summary, 177
 - B source, 177
 - bipolar junction transistor (BJT, 178
 - BJT, 241
 - bsource, 238
 - capacitor, 177, 186
 - controlled switch, 765
 - current controlled current source, 177, 234
 - current controlled switch, 178
 - current controlled voltage source, 177, 237
 - delay device, 776
 - digital devices, 178, 778
 - digital devices, Y type, 783
 - diode, 177, 207
 - equations, 177
 - generic switch, 178, 769
 - ideal delay device, 776
 - independent current source, 177
 - independent voltage source, 178, 221, 226
 - inductor, 177, 191
 - JFET, 178, 287
 - linear device, 178
 - lossless transmission line, 772
 - LTRA, 178
 - ltra, 763
 - lumped transmission line, 774
 - memristor, 178
 - MESFET, 178, 291
 - MOSFET, 178, 293
 - mutual inductor, 177
 - mutualinductor, 194
 - nodes, 182
 - nonlinear dependent source, 177
 - package options, 97
 - PDE Devices, 178, 807
 - port device, 178, 231
 - resistor, 178, 201
 - subcircuit, 178
 - transmission line, 178
 - lossless, 772
 - lossy, 763
 - lumped, 774
 - voltage controlled current source, 177, 235
 - voltage controlled switch, 178
 - voltage controlled voltage source, 177, 232
- diagnostic
 - options, 99
- Digital Devices, 178
- digital devices, 778
- diode, 207
 - device instance parameters, 208
 - device model parameters, 208
 - operating temperature, 207
- DIODE level 200
 - device output variables, 212
- DIODE level 2002

- device output variables, 216
- diodecnc 2.0.0
 - device instance parameters, 212
 - device model parameters, 213
- dist
 - options, 116, 117
- dopingprofiles
 - composite parameters, 814
- ekv mosfet version 2.6
 - device instance parameters, 737
 - device model parameters, 737
- ekv3 mosfet
 - device instance parameters, 740
 - device model parameters, 740
- embedded sampling analysis, 30
- EMBEDDEDSAMPLING analysis, 30
- expression based voltage or current source
 - device instance parameters, 240
- expressions
 - operators, 164
 - SPICE functions, 171
- fbh hbtv v2.1
 - device instance parameters, 259
 - device model parameters, 259
- fft, 35
 - additional metrics, 38
 - options, 37, 39, 117, 118
 - remeasure, 39
 - window functions, 37
- generic switch, 769
- harmonic balance analysis, 47
- hicum l0 v1.32
 - device instance parameters, 262
 - device model parameters, 262
- hicum v2.4.0
 - device model parameters, 267
- ideal transmission line
 - device instance parameters, 772
- illegal characters, 184
- independent voltage source, 221, 226
- inductor, 191
 - device instance parameters, 193
 - device model parameters, 193
- initial condition, 29, 48, 92
- DCVOLT, 29, 48
- IC, 48
- NODESET, 92
- JFET, 287
- jfet
 - device instance parameters, 288, 289
 - device model parameters, 288, 289
- juncap200 diode
 - device instance parameters, 209
 - device model parameters, 210
- Latin Hypercube Sampling analysis, 30, 150
- layer
 - composite parameters, 813
- lead currents, 131, 185
- legal characters, 184
- level parameter, 90
- LHS analysis, 30, 150
- lin
 - device model parameters, 770
- linear device, 770
- lossless transmission line, 772
- lossy transmission line, 763
 - device model parameters, 763
- lumped transmission line, 774
 - device instance parameters, 774
 - device model parameters, 774
- lutsoi mosfet
 - device instance parameters, 748
 - device model parameters, 748
- MC analysis, 30, 150
- measure
 - err1 measure, 72
 - err2 measure, 72
 - error measure, 72
 - additional examples, 70
 - expression support, 66
 - HSPICE compatibility, 75
 - measurement output, 65
 - measurement windows, 66
 - options, 118, 119
 - re-measure, 67
 - supported operators for AC measures, 73
 - supported operators for Noise measures, 73
 - suppressing measure output, 71
 - unsupported types, 74
- measure continuous

- AT and TD qualifiers for TRIG-TARG, 83
 - HSPICE compatibility, 83
 - measurement output, 81
 - rise, fall and cross qualifiers, 82
- measure fft
 - additional examples, 87
 - re-measure, 87
- memristor, 800
- memristorpem
 - device instance parameters, 804
 - device model parameters, 805
- memristorteam
 - device instance parameters, 802
 - device model parameters, 803
- memristoryakopcic
 - device instance parameters, 803
 - device model parameters, 803
- MESFET, 291
- mesfet
 - device instance parameters, 292
 - device model parameters, 292
- mextram 504.12.1
 - device instance parameters, 273
 - device model parameters, 273
- mextram 504.12.1 with self heating
 - device instance parameters, 280
 - device model parameters, 280
- Microsoft Windows, 857
- model
 - binning, 90
 - definition, 89
 - level parameter, 90
 - scale, 90
- model binning, 90, 119
- Monte Carlo analysis, 30, 150
- MOSFET, 293
- mosfet level 1
 - device instance parameters, 306
 - device model parameters, 306
- MOSFET level 102
 - device output variables, 487
- MOSFET level 10240
 - device output variables, 760
- MOSFET level 103
 - device output variables, 522
- MOSFET level 1031
 - device output variables, 558
- MOSFET level 107
 - device output variables, 691
- MOSFET level 108
 - device output variables, 725
- MOSFET level 110
 - device output variables, 660
- MOSFET level 111
 - device output variables, 623
- mosfet level 2
 - device instance parameters, 308
 - device model parameters, 308
- MOSFET level 2002
 - device output variables, 735
- mosfet level 3
 - device instance parameters, 310
 - device model parameters, 310
- mosfet level 6
 - device instance parameters, 312
 - device model parameters, 312
- MOSFET level 70
 - device output variables, 414
- MOSFET level 70450
 - device output variables, 443
- MOSFET level 77
 - device output variables, 472
- mutualinductor, 194
 - B-H loop calculations, 199
 - Converting nonlinear to linear mutual inductors, 199
 - mutual inductor equations, 197
- mvs etsoi 2.0.0
 - device model parameters, 728
- mvs hemt 2.0.0
 - device model parameters, 728
- mvsg-hv hemt model
 - device instance parameters, 730
 - device model parameters, 730
- netlist
 - commands, 24
 - comment, 163
 - expression operators, 164
 - functions, 171
 - in-line comment, 163
 - line continuation, 163
 - model definition, 177
 - nodes, 182
 - reference, 23
 - subcircuit, 177

- node
 - composite parameters, 813, 814
- Noise analysis, 93
- nonlinear mutual inductor
 - device model parameters, 195
- Operating Point, 27
- operating point analysis, 95
- output
 - control, 54, 78, 84
 - save, 152
- parallel
 - computing, 21
- parameters
 - convergence, 841
- parser
 - options, 119
- PCE analysis, 30, 122, 150
- PDE Devices, 178, 807
 - 1D instance parameters, 807, 811
 - model parameters, 807
 - Physical Models, 817
 - time integration parameters, 102
- POLY, 174
- port device, 231
- power calculations, 185
- power grid, 789
- power mosfet
 - device instance parameters, 380
 - device model parameters, 380
- powergridbranch
 - device instance parameters, 790
- powergridbusshunt
 - device instance parameters, 792
- powergridgenbus
 - device instance parameters, 795
- powergridtransformer
 - device instance parameters, 794
- psp102va legacy mosfet 102.5
 - device instance parameters, 475
 - device model parameters, 476
- psp103va mosfet
 - device instance parameters, 493
 - device model parameters, 494
- psp103va mosfet with self-heating
 - device instance parameters, 529
 - device model parameters, 530
- PSpice, 843, 849, 851
 - E device, 845
 - F device, 845
 - G device, 845
 - H device, 845
 - Probe, 129
- rawfile, 859
 - ASCII, 859
 - binary, 860
- region
 - composite parameters, 815
- resistor, 201
 - device instance parameters, 203, 204
 - device model parameters, 203, 205
- restart, 111
 - file, 112
 - two-level, 112
- results
 - fft, 35
 - measure, 58
 - measure continuous, 79
 - measure fft, 84
 - output control, 54, 78, 84
 - output options, 110
 - print, 25, 27, 47, 94, 128, 162
 - sens, 153
- SAMPLING analysis, 150
- sampling analysis, 150
- Sandia National Laboratories, 21
- save operating point conditions, 152
- scale, 90, 119
- sensitivity, 153
- solvers
 - continuation
 - options, 105
 - control parameters, 96
 - embeddedsampling
 - options, 113
 - hb
 - options, 116
 - homotopy
 - options, 105
 - linear
 - Aztec, 106, 109
 - iterative (preconditioned Krylov methods), 106

- options, 106, 109
- sparse-direct, 106
- Trilinos, 106, 109
- nonlinear
 - options, 103, 842
- nonlinear-transient
 - options, 104
- PCE
 - options, 114
- pce
 - options, 114
- sampling
 - options, 113
- sensitivity
 - options, 115
- sensitivty
 - options, 115
- time integration
 - options, 841
- time integration, 162, 850
 - options, 99, 103
- STEP analysis
 - Decade sweeps, 157
 - Linear sweeps, 155
 - List sweeps, 157
 - Octave sweeps, 157
- step parametric analysis, 155
- subcircuit, 159, 806
 - designation, 160
 - name, 159
 - nesting, 160
 - node zero, 160
 - scoping, 160
- TCAD Devices, 807
 - Physical Models, 817
 - time integration parameters, 102
- time step
 - size, 162, 850
- transient analysis, 103, 161
 - error tolerances, 841
- Trilinos, 106, 109
- Unix, 22
- Users of PSpice, 843
- Users of Xyce on Microsoft Windows, 857
- VBIC (temperature considerations), 245
 - device instance parameters, 250
 - device model parameters, 250
- vbic 1.3 4t
 - device instance parameters, 255
 - device model parameters, 255
- voltage controlled current source, 235
- voltage controlled voltage source, 232
- Voltage Nodes, 182
- voltage source
 - current controlled, 237
 - independent, 226
 - nonlinear dependent, 238
 - voltage controlled, 232
- Y type digital devices, 783

DISTRIBUTION

Email—Internal

Name	Org.	Sandia Email Address
Technical Library	1911	sanddocs@sandia.gov

This page intentionally left blank.



Sandia
National
Laboratories

Sandia National Laboratories is a multimission laboratory managed and operated by National Technology & Engineering Solutions of Sandia LLC, a wholly owned subsidiary of Honeywell International Inc., for the U.S. Department of Energy's National Nuclear Security Administration under contract DE-NA0003525.